



VISHWANIKETAN

Institute of Management Entrepreneurship and Engineering Technology

Survey No-52 Off Mumbai-Pune Expressway Kumbhivalli,

Tal- Khalapur, Maharashtra 410203.

Phone: (02192) 274206/274207/274208/274210

2016-2017

Sr. No.	Roll No.	Name of Student	Name of Program
1	SEA01	FULE SHRUTI PURUSHOTTAM	CIVIL ENGINEERING
2	SEA02	JHA DEEPAK SUSHILKUMAR	CIVIL ENGINEERING
3	SEA03	KANTHALE SHUBHAM DADANATH	CIVIL ENGINEERING
4	SEA04	NARONA SHASHIKANT HANUMANT	CIVIL ENGINEERING
5	SEA05	PATIL SIDDHANT ARUN	CIVIL ENGINEERING
6	SEA06	POKHARKAR NILESH RAMDAS	CIVIL ENGINEERING
7	SEA07	AUTADE KUNAL BHAUSAHEB VIDYA	CIVIL ENGINEERING
8	SEA08	BADE ASHWINI AJINATHI PRAVARA	CIVIL ENGINEERING
9	SEA09	BADE ROSHAN JAGDISH MEERA	CIVIL ENGINEERING
10	SEA10	BATHIJA KUNAL RAJESH SIMRAN	CIVIL ENGINEERING
11	SEA11	BHOITE VARSHA NATHA SUMAN	CIVIL ENGINEERING
12	SEA12	CHAUDHARI BHARAT SUNIL KIRTI	CIVIL ENGINEERING
13	SEA13	DUDUSKAR ROHAN SURESH SUCHITA	CIVIL ENGINEERING
14	SEA14	HEKRE SNEHAL	CIVIL ENGINEERING
15	SEA15	JADHAV AKSHAY ASHOK MEENAKSHI	CIVIL ENGINEERING
16	SEA16	JADHAV JIVAN KRISHNA JAYSHREE	CIVIL ENGINEERING
17	SEA17	JADHAV NISHANT SHANTARAM JAYSHREE	CIVIL ENGINEERING
18	SEA18	JAISWAL VIJAYLAXMI RAMANAND ASHA	CIVIL ENGINEERING
19	SEA19	JAISWAR PRANSHU RAMLAL PRATIMA	CIVIL ENGINEERING
20	SEA20	KARANDE MAHESH NANDKUMAR SNEHA	CIVIL ENGINEERING
21	SEA21	KASHID PRADIP SHIVAJI MEENA	CIVIL ENGINEERING
22	SEA22	KHARSAMBALE SONIYA HEMNATH MINAXI	CIVIL ENGINEERING
23	SEA23	KIRVE PRATHAMESH SUNIL RAJASHREE	CIVIL ENGINEERING
24	SEA24	KOLI SATYAJEET HARIDAS ROHINI	CIVIL ENGINEERING
25	SEA25	MADANE NANDINI DILIP SUMAN	CIVIL ENGINEERING
26	SEA26	MALI SAGAR SANTOSH ARCHANA	CIVIL ENGINEERING
27	SEA27	MHATRE CHHAYA SUBHASH SHUBHANGI	CIVIL ENGINEERING
28	SEA28	MHATRE SURAJ CHINTAMAN SHITAL	CIVIL ENGINEERING
29	SEA29	MORE VISHAKHA RAMCHANDRA UJWALA	CIVIL ENGINEERING
30	SEA30	OSWAL DUSHANT MANISH SANGITA	CIVIL ENGINEERING
31	SEA31	PATIL ANIKET ARUN NANDA	CIVIL ENGINEERING
32	SEA32	PATIL SAGAR SANDEEP SMITA	CIVIL ENGINEERING
33	SEA33	SANGE SUSHANT SANTOSH SANGEETA	CIVIL ENGINEERING
34	SEA34	SHAHASANE DURVESH UDAYKUMAR MEGHA	CIVIL ENGINEERING
35	SEA35	SONAWANE SHUBHAM DATTATRAY AMBIKA	CIVIL ENGINEERING
36	SEA36	SURVASE PRATIK DHANRAJ ANITA	CIVIL ENGINEERING
37	SEA37	TAMAKHE MANGESH BIRA KAMAL	CIVIL ENGINEERING
38	SEA38	THAKUR OMKAR ANAND NILAM	CIVIL ENGINEERING
39	SEA39	DHENDE MAYUR SIDDHARTH (P)	CIVIL ENGINEERING
40	SEA40	MHATRE PRAJKATA PRABHAKAR (P)	CIVIL ENGINEERING

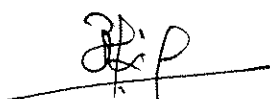

TRUE COPY

Principal
Vishwaniketan's (iMEET)

41	SEA41	BHOIR DIPESH VIJAY	CIVIL ENGINEERING
42	SEA42	BHOIR SHUBHAM HEMANT	CIVIL ENGINEERING
43	SEA43	CHOWDHARI CHINMAY PRAMOD	CIVIL ENGINEERING
44	SEA44	DHONGADE SANDHYA DHANANJAY	CIVIL ENGINEERING
45	SEA45	FERNANDES ALVES PEDRO	CIVIL ENGINEERING
46	SEA46	GAIKWAD HARSHADA POPAT	CIVIL ENGINEERING
47	SEA47	GANDAGE SHANKAR SHREEMANT	CIVIL ENGINEERING
48	SEA48	GHARAT KUNAL JAYDEV	CIVIL ENGINEERING
49	SEA49	INGOLE VIJAY DASHRATH	CIVIL ENGINEERING
50	SEA50	JONDALE SOHAM SHAILENDRA	CIVIL ENGINEERING
51	SEA51	KAMBLE KRUTIKA VIJAY	CIVIL ENGINEERING
52	SEA52	KHARATMOL SAGAR PANDURANG	CIVIL ENGINEERING
53	SEA53	KURANGALE KIRAN KRUSHNA	CIVIL ENGINEERING
54	SEA54	KURANKAR ANKITA SHREEDHAR	CIVIL ENGINEERING
55	SEA55	MANE SUMIT SUBHASH	CIVIL ENGINEERING
56	SEA56	MHATRE CHIRAYU JAHINDRANATH	CIVIL ENGINEERING
57	SEA57	MHATRE SAMIR SANJAY	CIVIL ENGINEERING
58	SEA58	PATIL DIPIL VIJAY	CIVIL ENGINEERING
59	SEA59	PATIL OMKAR MADHUKAR	CIVIL ENGINEERING
60	SEA60	PATIL PRACHIT PRAMOD	CIVIL ENGINEERING
61	SEA61	PATIL PRANAV PRABHAKAR	CIVIL ENGINEERING
62	SEA62	PATIL RAHUL TUKARAM	CIVIL ENGINEERING
63	SEA63	PAWAR NARAYAN MOTILAL	CIVIL ENGINEERING
64	SEA64	PAWAR SAGAR RAMESH	CIVIL ENGINEERING
65	SEA65	RAUT YOGESH RAJENDRA	CIVIL ENGINEERING
66	SEA66	REDDY SONIA RAKESH	CIVIL ENGINEERING
67	SEA67	RUPANVAR AKASH DATTU	CIVIL ENGINEERING
68	SEA68	SALAVI DARSHAN MANOHAR	CIVIL ENGINEERING
69	SEA69	SALUNKE SWAPNIL RAJU	CIVIL ENGINEERING
70	SEA70	SHAIKH RAHAMANSAB ABDUL	CIVIL ENGINEERING
71	SEA71	SHETE NIKHIL NAVIN	CIVIL ENGINEERING
72	SEA72	SHINDE SHUBHAM JAGANNATH	CIVIL ENGINEERING
73	SEA73	TUPE ANIKET ANANTA	CIVIL ENGINEERING
74	SEA74	VAGHANI PARTH DEVSHI	CIVIL ENGINEERING
75	SEA75	WAGHMARE ABHIJIT SUNIL	CIVIL ENGINEERING
76	SEA76	WASKAR PRATHAMESH KISHOR	CIVIL ENGINEERING
77	SEA77	YADAV RAJ DEEPAK	CIVIL ENGINEERING
78	SEB01	BHAGAT ACHAL VIJAY SARITA	CIVIL ENGINEERING
79	SEB02	BIRADAR AMAR SHRIKANT VIDYA	CIVIL ENGINEERING
80	SEB03	DESHMUKH MAYURI SANJAY CHITRA	CIVIL ENGINEERING
81	SEB04	DHAMANE SANDESH SHEKHER UJWALA	CIVIL ENGINEERING
82	SEB05	JAGDALE SAGAR HANMANT SHALAN	CIVIL ENGINEERING
83	SEB06	MAHADIK CHAITANYA CHANDRAKANT LAXMI	CIVIL ENGINEERING
84	SEB07	MANE VISHNU RAMCHANDRA GANGA	CIVIL ENGINEERING
85	SEB08	NAGDIVE NIVESH SUDHIR MRUDULA	CIVIL ENGINEERING
86	SEB09	NAIK VIKRANT VISHNU NIRMALA	CIVIL ENGINEERING
87	SEB10	PACHARNE BHAVNA NANASAHEB VARSHA	CIVIL ENGINEERING



TRUE COPY

[Signature]

Principal

Vishwaniketan (M.E.E.T)

88	SEB11	PAKHAR YOGESH RAMESH	CIVIL ENGINEERING
89	SEB12	PATIL HARSHADA GAJENDRA SANGITA	CIVIL ENGINEERING
90	SEB13	PATIL KEDAR SHARAD REKHA	CIVIL ENGINEERING
91	SEB14	PATIL PRANIT ANIL ANITA	CIVIL ENGINEERING
92	SEB15	PATIL RAHUL SURESH SUNITA	CIVIL ENGINEERING
93	SEB16	PATIL SAYLI KISHOR KALAVATI	CIVIL ENGINEERING
94	SEB17	POPHALE VIJAY RAJARAM DIPIKA	CIVIL ENGINEERING
95	SEB18	RAJGURU MAYURI RAJENDRA	CIVIL ENGINEERING
96	SEB19	SAWANT CHIRAG DEEPAK NIRMALA	CIVIL ENGINEERING
97	SEB20	SHENDGE MEGHA LAXMAN SHALAN	CIVIL ENGINEERING
98	SEB21	SURYAWANASHI MAYUR DINKAR PREMA	CIVIL ENGINEERING
99	SEB22	THAKUR SARVESH CHANDRASHEKHAR	CIVIL ENGINEERING
100	SEB23	YADAV SAURABH PRAVIN JAYMALA	CIVIL ENGINEERING
101	SEB24	ZIMBAL GIRISH VISHNU SANGEETA	CIVIL ENGINEERING
102	SEB25	GADGE AKASH BABAJI (P)	CIVIL ENGINEERING
103	SEB26	SHINDE ANKITA PRASHANT (P)	CIVIL ENGINEERING
104	SEB27	AHINAVE NIKHIL JALINDAR	CIVIL ENGINEERING
105	SEB28	AHIRRAO SNEHA RAJARAM	CIVIL ENGINEERING
106	SEB29	AMIRKHAN ABDUL RASID	CIVIL ENGINEERING
107	SEB30	BARASKAR DEVAYANI DNYANESHWAR	CIVIL ENGINEERING
108	SEB31	BHALEKAR AKSHAY SUBHASH	CIVIL ENGINEERING
109	SEB32	BHANGALE HEMANT PRAMOD	CIVIL ENGINEERING
110	SEB33	BHOIR VIJAY JAGANNATH	CIVIL ENGINEERING
111	SEB34	CHAVAN SHIVRAJ CHANDRAKANT	CIVIL ENGINEERING
112	SEB35	CHAWAN RAKESH ROHIDAS	CIVIL ENGINEERING
113	SEB36	CHEPATE RUSHIKESH GAHININATH	CIVIL ENGINEERING
114	SEB37	DESHMUKH SURAJ CHANDRAKANT	CIVIL ENGINEERING
115	SEB38	DHOBLE OMKAR RAMCHANDRA	CIVIL ENGINEERING
116	SEB39	GAIKWAD SWAPNIL SURYAKANT	CIVIL ENGINEERING
117	SEB40	GAIKWAD AMOL MADHUKAR	CIVIL ENGINEERING
118	SEB41	GAIKWAD SIDDHESH BHARAT	CIVIL ENGINEERING
119	SEB42	GAMARE SAGAR SUBHASH	CIVIL ENGINEERING
120	SEB43	GHANGHAV HARSHVARDHAN MUKUND	CIVIL ENGINEERING
121	SEB44	GODE ABHISHEK JAYDEEP	CIVIL ENGINEERING
122	SEB45	HARAD JITESH VILAS	CIVIL ENGINEERING
123	SEB46	JADHAV VISHAL PARSHURAM	CIVIL ENGINEERING
124	SEB47	KAMBLE ANJALI RAJESH	CIVIL ENGINEERING
125	SEB48	KAMBLE SHWETA SANJAY	CIVIL ENGINEERING
126	SEB49	KAMBLE TANMAY DAYANAND	CIVIL ENGINEERING
127	SEB50	KATLE VIKRANT HEMANT	CIVIL ENGINEERING
128	SEB51	KHUTLE PRATIKESH JAGANNATH	CIVIL ENGINEERING
129	SEB52	KUMAVAT KIRAN DAGA	CIVIL ENGINEERING
130	SEB53	MAHARNUR SURAJ KUMAR	CIVIL ENGINEERING
131	SEB54	MALUSARE AKASH ASHOK	CIVIL ENGINEERING
132	SEB55	MANGALE YOGESH MANSING	CIVIL ENGINEERING
133	SEB56	MHATRE AMITA RAMESH	CIVIL ENGINEERING
134	SEB57	MHATRE DIKSHITA BALIRAM	CIVIL ENGINEERING

TRUE COPY



[Signature]
Principal
Vishwaniketan's (i) MEET

135	SEB58	MHATRE HARSHALI JANARDAN	CIVIL ENGINEERING
136	SEB59	MHATRE KARAN GIRIDHAR	CIVIL ENGINEERING
137	SEB60	MHATRE PRATIK BHANUDAS	CIVIL ENGINEERING
138	SEB61	MHATRE TEJASVI RAVINDRA	CIVIL ENGINEERING
139	SEB62	MISAL VAIBHAVI SUNIL	CIVIL ENGINEERING
140	SEB63	MOHITE SHUBHAM ASHOK	CIVIL ENGINEERING
141	SEB64	NIMBALKAR VIRAJ VINAYKUMAR	CIVIL ENGINEERING
142	SEB65	OVHAL AKSHITA BHAGWAN	CIVIL ENGINEERING
143	SEB66	PATIL GIRISH PANDIT	CIVIL ENGINEERING
144	SEB67	PATIL MANALI MADHUKAR	CIVIL ENGINEERING
145	SEB68	PATIL PAYAL EKNATH	CIVIL ENGINEERING
146	SEB69	PATIL PRATIK NARAYAN	CIVIL ENGINEERING
147	SEB70	PATIL VARSHA DHANANJAY	CIVIL ENGINEERING
148	SEB71	PAWAR ASHUTOSH SHIVAJI NAGU	CIVIL ENGINEERING
149	SEB72	SHINDE SHUBHAM SUDHIR	CIVIL ENGINEERING
150	SEB73	SOLKAR ROHIT RAJENDRA	CIVIL ENGINEERING
151	SEB74	SONAWANE SHUBHAM HIRALAL	CIVIL ENGINEERING
152	SEB75	TAMGADGE ANIKET ANIL	CIVIL ENGINEERING
153	SEB76	WALSHINGE SHRADHA ARUN	CIVIL ENGINEERING
154	TEA01	BAVISKAR AMIT YUVARAJ	CIVIL ENGINEERING
155	TEA02	BHOIR APEKSHA ARVIND	CIVIL ENGINEERING
156	TEA03	CHAVARKAR NIKHIL KASHINATH	CIVIL ENGINEERING
157	TEA04	DHAVAN AJINKYA N.	CIVIL ENGINEERING
158	TEA05	DUKARE GAURAV RAMESH	CIVIL ENGINEERING
159	TEA06	GAWAND PRANALI DINANATH	CIVIL ENGINEERING
160	TEA07	GURAV RAKSHANDA SURENDRA	CIVIL ENGINEERING
161	TEA08	GAVAND RAHUL A.	CIVIL ENGINEERING
162	TEA09	HATNOLKAR KANCHAN R.	CIVIL ENGINEERING
163	TEA10	INGULKAR AKASH PRAKASH	CIVIL ENGINEERING
164	TEA11	JAIWAR DAISY RAMLAL	CIVIL ENGINEERING
165	TEA12	JAMBHALE PRAKASH DEEPAK	CIVIL ENGINEERING
166	TEA13	JOSHI ABHISHEK RAJEEV	CIVIL ENGINEERING
167	TEA14	KATKE GAJANAN	CIVIL ENGINEERING
168	TEA15	KADU VINAY GANESH	CIVIL ENGINEERING
169	TEA16	KALYADAPU VISHAL VISHNU	CIVIL ENGINEERING
170	TEA17	KANSAGRA PARTH SANJAYKUMAR	CIVIL ENGINEERING
171	TEA18	KARJIKAR YASIN RAZZAK M.	CIVIL ENGINEERING
172	TEA19	KARWAL RAHUL BHAUSAHEB	CIVIL ENGINEERING
173	TEA20	KHANOLKAR ADITYA UDAY	CIVIL ENGINEERING
174	TEA21	KSHIRSAGAR VAIBHAV R.	CIVIL ENGINEERING
175	TEA22	MASANE RAJENDRA KALURAM	CIVIL ENGINEERING
176	TEA23	MHATRE SAGAR V.	CIVIL ENGINEERING
177	TEA24	MHATRE PRANITA MUKUND	CIVIL ENGINEERING
178	TEA25	NAIK KRUPA SANTOSH	CIVIL ENGINEERING
179	TEA26	NAVALE SHUBHAM DATTATRAY	CIVIL ENGINEERING
180	TEA27	NIKAM ONKAR SHRIKANT	CIVIL ENGINEERING
181	TEA28	PALKAR MAYURESH	CIVIL ENGINEERING

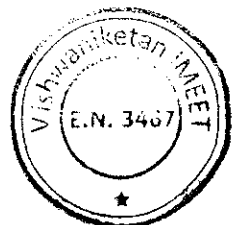

TRUE COPY

JKP

Principal

Vishwaniketan's (I) MEET

182	TEA29	PANDIT SIKANDAR	CIVIL ENGINEERING
183	TEA30	PARKAR PARAG KHANDOJI	CIVIL ENGINEERING
184	TEA31	PATIL AKASH C.	CIVIL ENGINEERING
185	TEA32	PATIL KOMAL DILIP	CIVIL ENGINEERING
186	TEA33	PATIL RHUSHIKESH RAMESH	CIVIL ENGINEERING
187	TEA34	PATIL SHRADDHA DAMODAR	CIVIL ENGINEERING
188	TEA35	PATIL SHUBHAM MOHAN	CIVIL ENGINEERING
189	TEA36	PATIL SUPRIYA PRAKASH	CIVIL ENGINEERING
190	TEA37	PAWAR SNEHAL ARUN	CIVIL ENGINEERING
191	TEA38	POPHALE SHUBHAM SURYKANT	CIVIL ENGINEERING
192	TEA39	RANE VASUDEV JAYWANT	CIVIL ENGINEERING
193	TEA40	RAUT SANCHITA SANTOSH	CIVIL ENGINEERING
194	TEA41	SAIFI MOHD JUNED JABIR	CIVIL ENGINEERING
195	TEA42	SARDESAI DIGVIJAY CHANDRAKANT	CIVIL ENGINEERING
196	TEA43	SATYAM VINAY GOPI	CIVIL ENGINEERING
197	TEA44	SENJALIYA DEEPESH RAMESH	CIVIL ENGINEERING
198	TEA45	SHAHASANE HARSHAL ANAND	CIVIL ENGINEERING
199	TEA46	SHETE SUMIT SOMNATH	CIVIL ENGINEERING
200	TEA47	SHAIKH NIHAL AHMED BILAL	CIVIL ENGINEERING
201	TEA48	SHINDE SOMNATH S.	CIVIL ENGINEERING
202	TEA49	SINGH SHAKTI PHOOLSINGH	CIVIL ENGINEERING
203	TEA50	SIGH SUSHIL	CIVIL ENGINEERING
204	TEA51	TALESA PRAVINKUMAR	CIVIL ENGINEERING
205	TEA52	TANPURE AKASH DILIP	CIVIL ENGINEERING
206	TEA53	VAIDYA PRATIK PRADEEP	CIVIL ENGINEERING
207	TEB01	BHARATI TUSHAR SANJAY	CIVIL ENGINEERING
208	TEB02	BHOIR HARSHAD HEMANT	CIVIL ENGINEERING
209	TEB03	BONAKUDATE JAYESH ASHOKKUMAR	CIVIL ENGINEERING
210	TEB04	CHAVAN TEJASHREE DADASAHEB	CIVIL ENGINEERING
211	TEB05	DAUR PRATIK TULSHIDAS	CIVIL ENGINEERING
212	TEB06	DAWANI MAYUR ASHOK	CIVIL ENGINEERING
213	TEB07	DESHMUKH KUNAL KISHOR	CIVIL ENGINEERING
214	TEB08	GAUD MANGESH SHYAMNARAYAN	CIVIL ENGINEERING
215	TEB09	GAVAND DHANANJAY DAMODAR	CIVIL ENGINEERING
216	TEB10	GHANGALE PRATIK ASHOK	CIVIL ENGINEERING
217	TEB11	GUPTA SACHIN RAMKRISHNA	CIVIL ENGINEERING
218	TEB12	HATE MANISH MUKESH	CIVIL ENGINEERING
219	TEB13	JADHAV AKASH BAPUSAHEB	CIVIL ENGINEERING
220	TEB14	JADHAV GAURAV MAHENDRA MOHINI	CIVIL ENGINEERING
221	TEB15	JAMDHADE SHUBHAM DIGAMBAR	CIVIL ENGINEERING
222	TEB16	JERATH SHIKHAR MANISH	CIVIL ENGINEERING
223	TEB17	KHANDAGALE DHIRAJ NANASO	CIVIL ENGINEERING
224	TEB18	KHANDAGALE HRUSHIKESH RAJENDRA	CIVIL ENGINEERING
225	TEB19	KOLI VINESH SHIVDAS	CIVIL ENGINEERING
226	TEB20	KONAR SRIDHAR BALASUBRAMANIAN	CIVIL ENGINEERING
227	TEB21	KUDALE POONAM JAGANNATH	CIVIL ENGINEERING
228	TEB22	LOHAR AKSHAY ARVIND	CIVIL ENGINEERING



TRUE COPY

[Handwritten Signature]

Principal

Vishwaniketan's (i) MEET

229	TEB23	MANAJI TEJASWINI RAJARAM	CIVIL ENGINEERING
230	TEB24	MANYAR JUBER TAYYAB ALI BISMILLAH	CIVIL ENGINEERING
231	TEB25	MHASKAR SAMEER GOVIND	CIVIL ENGINEERING
232	TEB26	MHATRE KUNAL SHASHIKANT	CIVIL ENGINEERING
233	TEB27	MHATRE PRANAV KAMALAKAR	CIVIL ENGINEERING
234	TEB28	MHATRE SHUBHAM KISHOR	CIVIL ENGINEERING
235	TEB29	MHATRE SUJATA NIVRUTTI	CIVIL ENGINEERING
236	TEB30	NAIK YASIN HABIBULLA	CIVIL ENGINEERING
237	TEB31	NALAWADE AJINKYA RAMESH	CIVIL ENGINEERING
238	TEB32	NANGARE ADITI RAVIKANT	CIVIL ENGINEERING
239	TEB33	OULKAR SHUBHAM HEMANTRAO	CIVIL ENGINEERING
240	TEB34	PATIL ABHIJIT NARENDRA	CIVIL ENGINEERING
241	TEB35	PATIL AKSHAY NAMDEV	CIVIL ENGINEERING
242	TEB36	PATIL ANIKET ASHOK	CIVIL ENGINEERING
243	TEB37	PATIL BHAVESH HEMCHANDRA	CIVIL ENGINEERING
244	TEB38	PATIL MANALI CHANDRAKANT	CIVIL ENGINEERING
245	TEB39	PATIL PRATHAMESH MACHHINDRA	CIVIL ENGINEERING
246	TEB40	PATIL PRIYANKA RAGHUNATH	CIVIL ENGINEERING
247	TEB41	PATIL VAISHNAVI PANDHARINATH	CIVIL ENGINEERING
248	TEB42	POKALE SUHAS HANUMANT	CIVIL ENGINEERING
249	TEB43	RATHOD VIJAY GOVIND	CIVIL ENGINEERING
250	TEB44	SAGWEKAR ROHAN PRAKASH	CIVIL ENGINEERING
251	TEB45	SALUNKHE PRATIK CHANDRAKANT	CIVIL ENGINEERING
252	TEB46	SANAS OMKAR VITHAL	CIVIL ENGINEERING
253	TEB47	SATHELKAR BHAKTI GURUNATH	CIVIL ENGINEERING
254	TEB48	SAWANT PRATIK CHANDRAKANT	CIVIL ENGINEERING
255	TEB49	SHAHASANE NISHAD PRADEEP	CIVIL ENGINEERING
256	TEB50	SHEDAVAL SHUBHAM SANJAY	CIVIL ENGINEERING
257	TEB51	SHELKE SAGAR GOVIND	CIVIL ENGINEERING
258	TEB52	SHIGVAN SURAJ DAYANESHWAR	CIVIL ENGINEERING
259	TEB53	SHINDE SHUBHAM RAMDAS	CIVIL ENGINEERING
260	TEB54	SONAR MEGHNA VIJAY	CIVIL ENGINEERING
261	TEB55	SURYAVANSHI ADITYA ANGAD	CIVIL ENGINEERING
262	TEB56	SWAMI TEJAS JAGAN	CIVIL ENGINEERING
263	TEB57	TAMBE PRATIK KHANDU	CIVIL ENGINEERING
264	TEB58	THOMBARE SURAJ SURESH	CIVIL ENGINEERING
265	TEB59	WADIKAR SARVESH SHASHIKANT	CIVIL ENGINEERING
266	TEB60	WAGH TANMAY PANDURANG	CIVIL ENGINEERING
267	BE01	BANKAR MAYURESH BALU MANGALA	CIVIL ENGINEERING
268	BE02	BHAGAT PRASHANT BALU PARVATI	CIVIL ENGINEERING
269	BE03	BHILARE ROHIT RAJARAM	CIVIL ENGINEERING
270	BE04	BHOSALE RESHMA VITHOBA LAXMI	CIVIL ENGINEERING
271	BE05	CHORGHE NAVNATH YASHWANT SANJANA	CIVIL ENGINEERING
272	BE06	DAHIYA VIJAYKUMAR SURESHKUMAR	CIVIL ENGINEERING
273	BE07	DALVI KALPESH MANOHAR	CIVIL ENGINEERING
274	BE08	DONGRE AAKASH RAJENDRA SUNITA	CIVIL ENGINEERING
275	BE09	GAIKWAD PRATIKSHA HANUMANT	CIVIL ENGINEERING



TRUE COPY

(Signature)

Principal
Vishwaniketan's (A)EET

276	BE10	GHARAT ABHISHEK PRAFULL DHANASHRI	CIVIL ENGINEERING
277	BE11	GODBOLE SAHIL RAJENDRA YASHODHRA	CIVIL ENGINEERING
278	BE12	HULLA VIJAY RAJSHEKHAR SUVARNA	CIVIL ENGINEERING
279	BE13	JAMADADE SONALI VITTHAL LATA	CIVIL ENGINEERING
280	BE14	KADAM OMKAR LAXMAN SHILPA	CIVIL ENGINEERING
281	BE15	KADAM SWAPNIL GAJANAN	CIVIL ENGINEERING
282	BE16	KASARE SWAPNIL PRABHAKAR KARUNA	CIVIL ENGINEERING
283	BE17	KATKAR SUSHANT EKNATH	CIVIL ENGINEERING
284	BE18	KOLI SHREYASH JAGDISH	CIVIL ENGINEERING
285	BE19	MALI NIKITA MARUTI MADHAVI	CIVIL ENGINEERING
286	BE20	MANDHARE GANESH MARUTI SADHANA	CIVIL ENGINEERING
287	BE21	MHATRE HANUMANT BUDHAJI	CIVIL ENGINEERING
288	BE22	MORE RAKESH RAJARAM GITA	CIVIL ENGINEERING
289	BE23	NAIKWADI BHUSHAN DILIP VIMAL	CIVIL ENGINEERING
290	BE24	NISHAD PINTU KHUSHIYAL	CIVIL ENGINEERING
291	BE25	PAL ROHIT RAMESEVAK	CIVIL ENGINEERING
292	BE26	PANCHAL HEMANT GANESH GEETANJALI	CIVIL ENGINEERING
293	BE27	PATIL ARATI RAVINDRA MANISHA	CIVIL ENGINEERING
294	BE28	PATIL ASHISH SUBHASH SAVITA	CIVIL ENGINEERING
295	BE29	PATIL OMKAR AVINASH KAVITA	CIVIL ENGINEERING
296	BE30	PATIL POONAM NARESH NISHA	CIVIL ENGINEERING
297	BE31	PATIL PRITESH MAHESH	CIVIL ENGINEERING
298	BE32	PATIL VINAY SOPAN SUNITA	CIVIL ENGINEERING
299	BE33	PRAJAPATI SURAJ NANDVIJAY	CIVIL ENGINEERING
300	BE34	RAMEKAR TANMAY PRASHANT	CIVIL ENGINEERING
301	BE35	SALVI OMKAR DATTARAM ASHA	CIVIL ENGINEERING
302	BE36	SANAP VISHAL EKNATH NANDA	CIVIL ENGINEERING
303	BE37	SAYYED SOHAIL NABI SHAINAJ	CIVIL ENGINEERING
304	BE38	SHARMA VIKAS RAJKUMAR	CIVIL ENGINEERING
305	BE39	SHINDE VIVEK DILIP ANJANI	CIVIL ENGINEERING
306	BE40	SINGH SANDEEP JAIRAM SUMAN	CIVIL ENGINEERING
307	BE41	THAKUR OMKAR DINANATH	CIVIL ENGINEERING
308	BE42	TIRLOTKAR AMIT SADANAND	CIVIL ENGINEERING
309	BE43	YADAV RAHUL CHHEDI SHILA	CIVIL ENGINEERING
310	BE44	YADAV VAIDEHI PRAMOD	CIVIL ENGINEERING
311	BE45	YESALE VAIBHAV LAXMAN ASHA	CIVIL ENGINEERING
312	BE46	ZANZANE AKSHAY SUDAM SHARDA	CIVIL ENGINEERING
313	BE47	SAIFI MOHD JAVED JABIR HUSSAIN	CIVIL ENGINEERING
314	BE48	PAWAR ANIKET	CIVIL ENGINEERING
315	SCS01	AVALE RANJANA VINAYAK	COMPUTE R ENGINEERING
316	SCS02	AWASKAR ELIYAHOO JOEL	COMPUTE R ENGINEERING
317	SCS03	BADGUJAR MANASI SUNIL	COMPUTE R ENGINEERING
318	SCS04	BANDAWANE TEJAS SUBHASH	COMPUTE R ENGINEERING
319	SCS05	BHANDARI RICHA SARITA	COMPUTE R ENGINEERING
320	SCS06	BHOIR JAYESH RAMAKANT	COMPUTE R ENGINEERING
321	SCS07	BHOSEKAR PRANJAL PRADIP	COMPUTE R ENGINEERING
322	SCS08	BORSE GAURI RAJENDRA	COMPUTE R ENGINEERING

TRUE COPY



Principals
Principals
 Vishwaniketan IMEET

323	SCS09	CHAUDHARI DEEPA BHIMRAO	COMPUTE R ENGINEERING
324	SCS10	CHAVAN AJAY ARUN	COMPUTE R ENGINEERING
325	SCS11	CHAVAN KIRAN MHATARDEV	COMPUTE R ENGINEERING
326	SCS12	CHAVAN SHUBHAM ANANDRAO	COMPUTE R ENGINEERING
327	SCS13	DABHADE PRATIKSHA SARJERAO	COMPUTE R ENGINEERING
328	SCS14	DABIR JITESH KASHINATH	COMPUTE R ENGINEERING
329	SCS15	DALAVI JIVITESH MARUTI	COMPUTE R ENGINEERING
330	SCS16	DALVI SAURABH GAJANAN	COMPUTE R ENGINEERING
331	SCS17	DESHMUKH MAITHILI SURESH	COMPUTE R ENGINEERING
332	SCS18	DESHMUKH PRATIK DNYANESHWAR	COMPUTE R ENGINEERING
333	SCS19	DESHPANDE SUTEJ SUNIL	COMPUTE R ENGINEERING
334	SCS20	DHANAWADE MEGHA SHIVRAM	COMPUTE R ENGINEERING
335	SCS21	DHEMBRE SHWETALI APPASAHEB	COMPUTE R ENGINEERING
336	SCS22	DHUMAL JUILEE ROHIDAS	COMPUTE R ENGINEERING
337	SCS23	GANGANE TEJALI RAMESH	COMPUTE R ENGINEERING
338	SCS24	GHARAT SANDESH BHARAT	COMPUTE R ENGINEERING
339	SCS25	GHOSH SOURABH NARAYAN	COMPUTE R ENGINEERING
340	SCS26	GUPTA SHRISTI GULAB	COMPUTE R ENGINEERING
341	SCS27	JADHAV SHRADDHA SAMBHAJIRAO	COMPUTE R ENGINEERING
342	SCS28	JADHAV SHRADHA SHITAL	COMPUTE R ENGINEERING
343	SCS29	JADHAV SHREYA SAMBHAJIRAO	COMPUTE R ENGINEERING
344	SCS30	KALEKAR JAGRUTI EKNATH	COMPUTE R ENGINEERING
345	SCS31	KAUSHIK RAJNISH PAWAN	COMPUTE R ENGINEERING
346	SCS32	KOLI SHRADDHA JAGAN	COMPUTE R ENGINEERING
347	SCS33	KUBAL SANIKA VILAS	COMPUTE R ENGINEERING
348	SCS34	LOHAR AISHWARYA MAHADEO	COMPUTE R ENGINEERING
349	SCS35	MADHAVI PRADNYA DILIP	COMPUTE R ENGINEERING
350	SCS36	MALI MAYURI MAHENDRA	COMPUTE R ENGINEERING
351	SCS37	MAPARA JAFAR YASIN	COMPUTE R ENGINEERING
352	SCS38	MHATRE TRIVENI PARSHURAM	COMPUTE R ENGINEERING
353	SCS39	MISHRA SATYAPRAKASH NAVNEET	COMPUTE R ENGINEERING
354	SCS40	MOKAL VARUN VIKAS	COMPUTE R ENGINEERING
355	SCS41	NAGLE TANVI PARAG	COMPUTE R ENGINEERING
356	SCS42	PACHPOR RAM SANJAY	COMPUTE R ENGINEERING
357	SCS43	PANCHAL DARSHANA SATISH	COMPUTE R ENGINEERING
358	SCS44	PANDEY VISHANT RAMESHWAR	COMPUTE R ENGINEERING
359	SCS45	PASHILKAR MADHURA RAJENDRA	COMPUTE R ENGINEERING
360	SCS46	PATHAK SHAGUN SUDHISH	COMPUTE R ENGINEERING
361	SCS47	PATIL ANKITA SHRIKANT	COMPUTE R ENGINEERING
362	SCS48	PATIL HARSHADA BHARAT	COMPUTE R ENGINEERING
363	SCS49	PATIL MONALI HARISHCHANDRA	COMPUTE R ENGINEERING
364	SCS50	PATIL NEHA RAJESH	COMPUTE R ENGINEERING
365	SCS51	PATIL PRASAD SHANTARAM	COMPUTE R ENGINEERING
366	SCS52	PATIL PRITI DEEPAK	COMPUTE R ENGINEERING
367	SCS53	PATIL Sampada Sanjay	COMPUTE R ENGINEERING
368	SCS54	PATIL SANJOG SANJAY	COMPUTE R ENGINEERING
369	SCS55	PATIL SHUBHAM PRADEEP	COMPUTE R ENGINEERING



TRUE COPY

Principal
Vishwaniketan's (I)EET

370	SCS56	PATIL SNEHAL RAMCHANDRA	COMPUTE R ENGINEERING
371	SCS57	PATIL VISHAL BHAGWAN	COMPUTE R ENGINEERING
372	SCS58	RAMANE SAYALI ARVIND	COMPUTE R ENGINEERING
373	SCS59	SAHANI SANJAY RAMAWADH	COMPUTE R ENGINEERING
374	SCS60	SALVI AKSHAY NANDKUMAR	COMPUTE R ENGINEERING
375	SCS61	SANKHE SAISH ANIL	COMPUTE R ENGINEERING
376	SCS62	SAWANT RAJASHREE VASANT	COMPUTE R ENGINEERING
377	SCS63	SHAH PRANEET KIRAN	COMPUTE R ENGINEERING
378	SCS64	SHETTY MANJUSH SANTOSH	COMPUTE R ENGINEERING
379	SCS65	SINGH ABHISHEK OMPRAKASH	COMPUTE R ENGINEERING
380	SCS66	SINGH POOJA KAMESHWAR	COMPUTE R ENGINEERING
381	SCS67	SINGH SURUCHI SANTOSH	COMPUTE R ENGINEERING
382	SCS68	SOLANKI AKSHAY MUKESH	COMPUTE R ENGINEERING
383	SCS69	SOMWANSHI ADITYA ASHOK	COMPUTE R ENGINEERING
384	SCS70	SURVE DAMINI SUDHIR	COMPUTE R ENGINEERING
385	SCS71	THAKARE ASHWINI TULSHIRAM	COMPUTE R ENGINEERING
386	SCS72	TYAGI ISHITA UDYANKUMAR	COMPUTE R ENGINEERING
387	SCS73	VINJAMURI VEDHAS SESHASAI	COMPUTE R ENGINEERING
388	SCS74	WAGHMARE PRITISH RAVINDRA	COMPUTE R ENGINEERING
389	SCS75	WAKATI PRATIK SHESHNATH	COMPUTE R ENGINEERING
390	SCS76	WALKE MAHESH SANJAY	COMPUTE R ENGINEERING
391	SCS77	WANKHEDE SNEHA ANIL	COMPUTE R ENGINEERING
392	SCS78	YEWALE OMKAR VILAS	COMPUTE R ENGINEERING
393	TCS01	ABHANG PRANITA MARUTI	COMPUTE R ENGINEERING
394	TCS02	BANDHU SHIVAM SUNILKUMAR	COMPUTE R ENGINEERING
395	TCS03	BHALEKAR DIPTI HARIBHAU	COMPUTE R ENGINEERING
396	TCS04	BHOSALE NAMRATA NITIN	COMPUTE R ENGINEERING
397	TCS05	BODKE SHRIKANT SANTOSH	COMPUTE R ENGINEERING
398	TCS06	BURUMKAR SWEETY SANJAY	COMPUTE R ENGINEERING
399	TCS07	CHAVAN SONAL SUHAS	COMPUTE R ENGINEERING
400	TCS08	DAS PRAVIN KUMAR	COMPUTE R ENGINEERING
401	TCS09	DIGHORE KAJAL VASANT	COMPUTE R ENGINEERING
402	TCS10	DIXIT VINAYAK CHANDRAKANT	COMPUTE R ENGINEERING
403	TCS11	GHARAT MANASVI VILAS	COMPUTE R ENGINEERING
404	TCS12	JADHAV ATUL SATISH	COMPUTE R ENGINEERING
405	TCS13	JADHAV SHEKHAR ASHOK	COMPUTE R ENGINEERING
406	TCS14	JADHAV VRUSHAB SATISH	COMPUTE R ENGINEERING
407	TCS15	JUWATKAR KALPASHREE GOVIND	COMPUTE R ENGINEERING
408	TCS16	KADAM AMRUTA DHANANJAY	COMPUTE R ENGINEERING
409	TCS17	KADAM KOMAL TANAJI	COMPUTE R ENGINEERING
410	TCS18	KADAM SHAILESH PRAKASH	COMPUTE R ENGINEERING
411	TCS19	KADAM SHUBHAM RAMCHANDRA	COMPUTE R ENGINEERING
412	TCS20	KADAV SANDEEP SURESH	COMPUTE R ENGINEERING
413	TCS21	KALAMBE AKSHAY RAJENDRA	COMPUTE R ENGINEERING
414	TCS22	KAMIL SUMAIR MOHD	COMPUTE R ENGINEERING
415	TCS23	KAMLE PRATIK PRALHAD	COMPUTE R ENGINEERING
416	TCS24	KAPSE TEJASHREE ARUN	COMPUTE R ENGINEERING

TRUE COPY



Principal
Principal
Vishwaniketan's (I) MEET

417	TCS25	KARANDE ANKITA PRAKASHI	COMPUTE R ENGINEERING
418	TCS26	KARVE ROHAN CHANDRAKANT	COMPUTE R ENGINEERING
419	TCS27	KATARIYA RISHABH MAHENDRA	COMPUTE R ENGINEERING
420	TCS28	KISAVE AKSHAY MANOHAR	COMPUTE R ENGINEERING
421	TCS29	KONDE AKSHAY DATTATRAY	COMPUTE R ENGINEERING
422	TCS30	KURANGALE JAGRUTI BHARAT	COMPUTE R ENGINEERING
423	TCS31	LOTE PAYAL SUNIL	COMPUTE R ENGINEERING
424	TCS32	LOTE PUJA RAJENDRA	COMPUTE R ENGINEERING
425	TCS33	MARATHE PADMAJA NARENDRA	COMPUTE R ENGINEERING
426	TCS34	MHATRE PRADNYA SHASHIKANT	COMPUTE R ENGINEERING
427	TCS35	MITHARI SAURABH GAJANAN	COMPUTE R ENGINEERING
428	TCS36	MORE VAIBHAV AMBADAS	COMPUTE R ENGINEERING
429	TCS37	MUNDE ARPITA ANANT	COMPUTE R ENGINEERING
430	TCS38	MUNOT SHREYAS SUNIL	COMPUTE R ENGINEERING
431	TCS39	PADTE SIDDHESH DAMODAR	COMPUTE R ENGINEERING
432	TCS40	PALAVE ANIKET NIVRUTI	COMPUTE R ENGINEERING
433	TCS41	PATIL POOJA BALKRISHNA	COMPUTE R ENGINEERING
434	TCS42	PATIL PRADNYA BHAGWAN	COMPUTE R ENGINEERING
435	TCS43	PATIL SNEHAL PRATAP	COMPUTE R ENGINEERING
436	TCS44	PATIL SUPRIYA VILAS	COMPUTE R ENGINEERING
437	TCS45	PATIL VIKAS BALARAM	COMPUTE R ENGINEERING
438	TCS46	PATIL VINAYAK SHIVAJI	COMPUTE R ENGINEERING
439	TCS47	PAWAR SHREEHARI CHANDRASHEKHAR	COMPUTE R ENGINEERING
440	TCS48	RAHATE SHUBHANKAR DILIP	COMPUTE R ENGINEERING
441	TCS49	ROMINA MANOJ NARAYANLAL	COMPUTE R ENGINEERING
442	TCS50	SATRE VIKRAM VITTHAL	COMPUTE R ENGINEERING
443	TCS51	SHENDE NAMRATA RAMAKANT	COMPUTE R ENGINEERING
444	TCS52	SHINDE PURVA RANAJIT	COMPUTE R ENGINEERING
445	TCS53	SHIRGAONKAR TEJAS	COMPUTE R ENGINEERING
446	TCS54	SINGH AALOK KAMALAKISHOR	COMPUTE R ENGINEERING
447	TCS55	SINGH SONALI SHAILENDRA	COMPUTE R ENGINEERING
448	TCS56	SONAWANE PIYUSH RAVINDRA	COMPUTE R ENGINEERING
449	TCS57	SURYAVANSHI VIKAS SHIVAJI	COMPUTE R ENGINEERING
450	TCS58	THETE PARMESHVAR BABRUVAN	COMPUTE R ENGINEERING
451	TCS59	THOMBARE PRABODH ANIL	COMPUTE R ENGINEERING
452	TCS60	THORAT KUNAL ADHIKRAO	COMPUTE R ENGINEERING
453	TCS61	THOSAR ANIKET VINAYAK	COMPUTE R ENGINEERING
454	TCS62	TILEKAR AJAY MOHAN	COMPUTE R ENGINEERING
455	BCS01	BADANAPURKAR PRITHA PRAKASH	COMPUTE R ENGINEERING
456	BCS02	BHANDARY DEEPA GANGADHARA	COMPUTE R ENGINEERING
457	BCS03	BHOIR HEMLATA PANDHARINATH	COMPUTE R ENGINEERING
458	BCS04	BHOIR MAMTA RAMESH	COMPUTE R ENGINEERING
459	BCS05	CHANDA SUNNY DEBASHIS	COMPUTE R ENGINEERING
460	BCS06	DHENE MAYUR BHASKAR	COMPUTE R ENGINEERING
461	BCS07	DHUMAL DIKSHA SURESH	COMPUTE R ENGINEERING
462	BCS08	GHARGE RISHIKESH SHIVAJI	COMPUTE R ENGINEERING
463	BCS09	GHODVINDE SONALI SHASHIKANT	COMPUTE R ENGINEERING

TRUE COPY



[Signature]
Principal

Vishwaniketan's (I MET)

464	BCS10	GIRI NEERAJ BHAGWAN	COMPUTER ENGINEERING
465	BCS11	INAMDAR VAISHNAVI SANDEEP	COMPUTER ENGINEERING
466	BCS12	MALODE YOGITA DILIP	COMPUTER ENGINEERING
467	BCS13	MUDALIYAR SANTOSH	COMPUTER ENGINEERING
468	BCS14	PAL YASH VISHANT	COMPUTER ENGINEERING
469	BCS15	PAL SANJAYKUMAR SURESH	COMPUTER ENGINEERING
470	BCS16	PATIL POOJA SUBHASH	COMPUTER ENGINEERING
471	BCS17	PATIL SHRUTI SANDESH	COMPUTER ENGINEERING
472	BCS18	PATIL SHWETA ANANT	COMPUTER ENGINEERING
473	BCS19	PAWAR BHAGYASHREE KASHINATH	COMPUTER ENGINEERING
474	BCS20	PAWAR POOJA YASHWANT	COMPUTER ENGINEERING
475	BCS21	PRAJAPATI RANVIJAY RAMBHUI	COMPUTER ENGINEERING
476	BCS22	ROUT SUNNY VIJAY	COMPUTER ENGINEERING
477	BCS23	SAAV MURLIDHAR SUKHLAL	COMPUTER ENGINEERING
478	BCS24	SAHANI RAHUL PATIRAM	COMPUTER ENGINEERING
479	BCS25	SHAH DEEPALI JAGDISH	COMPUTER ENGINEERING
480	BCS26	SHAIKH QAIF AMAAN TANVEER AHMED	COMPUTER ENGINEERING
481	BCS27	SHINGRUT ABHIJEET SHARAD	COMPUTER ENGINEERING
482	BCS28	SHIRKE SHEETAL DAYANAND	COMPUTER ENGINEERING
483	BCS29	SINGH.PRABHAT OMPRAKASH	COMPUTER ENGINEERING
484	BCS30	SINGH SHUBHAM UDAYBHAN	COMPUTER ENGINEERING
485	BCS31	WAGH JYOTI JIJABHAU	COMPUTER ENGINEERING
486	BCS32	WAGH PRATIK PRAMOD	COMPUTER ENGINEERING
487	BCS33	WALALI PRAJYOT PRASHANT	COMPUTER ENGINEERING
488	BCS34	YADAV NISHA UMESHCHAND	COMPUTER ENGINEERING
489	SE01	/ADOLE APURVA SUKHDEV SANJIVANI	ELECTRICAL ENGINEERING
490	SE02	BAKKAR NIMISH BALKRISHNA NISHIGANDHA	ELECTRICAL ENGINEERING
491	SE03	BARAD YOGESH SUNIL BHARTI	ELECTRICAL ENGINEERING
492	SE04	BHATKAR PRATHAMESH DILIP DIPIKA	ELECTRICAL ENGINEERING
493	SE05	BHAYE BHUSHAN ARVIND URMILA	ELECTRICAL ENGINEERING
494	SE06	BHIDE SWANAND SHRIKANT MADHURA	ELECTRICAL ENGINEERING
495	SE07	BHISE ARJUN TUKARAM PRITI	ELECTRICAL ENGINEERING
496	SE08	BHOIR ASHUTOSH SHAMRAV SHILPA	ELECTRICAL ENGINEERING
497	SE09	BHOSALE UDAY SANJAY SANJIVANI	ELECTRICAL ENGINEERING
498	SE10	BORUDE SAGAR AMBADAS TARABAI	ELECTRICAL ENGINEERING
499	SE11	CHALKE DHEERAJ VASANT RANJANA	ELECTRICAL ENGINEERING
500	SE12	CHANDORKAR KUNAL MUKUND MEENA	ELECTRICAL ENGINEERING
501	SE13	DALVI SANKET SANTOSH SUJATA	ELECTRICAL ENGINEERING
502	SE14	DALVI VIRAJ SANTOSH SHARADA	ELECTRICAL ENGINEERING
503	SE15	DESAI SURAJ VITTHAL SAVITA	ELECTRICAL ENGINEERING
504	SE16	DESHMUKH SAURABH DNYANESHWAR RANJANA	ELECTRICAL ENGINEERING
505	SE17	/DESHMUKH SHILPA SHRIKANT ALAKA	ELECTRICAL ENGINEERING
506	SE18	DOIPHODE PANKAJ BHIM POURNIMA	ELECTRICAL ENGINEERING
507	SE19	FOFERKAR PRANAY VILAS PRAFULLA	ELECTRICAL ENGINEERING
508	SE20	GAIKWAD VAIBHAV SIDDHARTH SUNITA	ELECTRICAL ENGINEERING
509	SE21	/GHARAT DAMINI SANTOSH BHARTI	ELECTRICAL ENGINEERING
510	SE22	GHARATKAR SIDDESH VIKAS SANJIVANI	ELECTRICAL ENGINEERING



TRUE COPY

JKP

Principal
Vishwaniketan's (i MEET)

511	SE23	GHAYTADAK SUMIT SHAMRAO SUJATA	ELECTRICAL ENGINEERING
512	SE24	GHUDE HARSHAL MANOHAR SANGITA	ELECTRICAL ENGINEERING
513	SE25	GURAV PRANAY PRASHANT	ELECTRICAL ENGINEERING
514	SE26	/GIRI ARATI NARENDRA SNEHA	ELECTRICAL ENGINEERING
515	SE27	INCHANALKAR POOJA BAPUSAHEB	ELECTRICAL ENGINEERING
516	SE28	JADHAV RAJKUMAR YUVRAJ MANGALA	ELECTRICAL ENGINEERING
517	SE29	JADHAV SURAJ DHONDURAM PRIYANKA	ELECTRICAL ENGINEERING
518	SE30	JADHAV SURAJ SUNIL VANDANA	ELECTRICAL ENGINEERING
519	SE31	JAMDADE VISHAL DHONDIRAM JANNABAI	ELECTRICAL ENGINEERING
520	SE32	KADAM ASHWINKUMAR ASHOK SWATI	ELECTRICAL ENGINEERING
521	SE33	KAKAD SAGAR SUBHASH PUSHPA	ELECTRICAL ENGINEERING
522	SE34	/KOLI SONALI SUNIL SUREKHA	ELECTRICAL ENGINEERING
523	SE35	KOLI SUMIT RAJU DHANWANTI	ELECTRICAL ENGINEERING
524	SE36	LOHOT HRISHIKESH BALU LALITA	ELECTRICAL ENGINEERING
525	SE37	MAHIMKAR ABHISHEK SAMEER	ELECTRICAL ENGINEERING
526	SE38	/MAITY SUDEEPA SUBODH DEEPA	ELECTRICAL ENGINEERING
527	SE39	MHATRE CHETAN KIRAN DYAMANTI	ELECTRICAL ENGINEERING
528	SE40	MHATRE MANDAR RAMAKANT RESHMA	ELECTRICAL ENGINEERING
529	SE41	MHATRE SHEKAHAR KASHINATH NANDA	ELECTRICAL ENGINEERING
530	SE42	MIRGAL PARESH MANOHAR MADHURI	ELECTRICAL ENGINEERING
531	SE43	MORE HARISH ANKUSH LATA	ELECTRICAL ENGINEERING
532	SE44	MULIK MAYUR KRISHNARAO BHARATI	ELECTRICAL ENGINEERING
533	SE45	NARSINGH APURV DHARMENDRA	ELECTRICAL ENGINEERING
534	SE46	PANDEY GAURAV BIRENDRA PUSHPA	ELECTRICAL ENGINEERING
535	SE47	PANDEY ROUSHAN VIJAY RANJU	ELECTRICAL ENGINEERING
536	SE48	/PANSANDE SWAPNALI CHANDRASHEKHAR	ELECTRICAL ENGINEERING
537	SE49	PARINGE NITESH BHAGA SUNITA	ELECTRICAL ENGINEERING
538	SE50	PARULEKAR ADITYA SURENDRA SUVARNA	ELECTRICAL ENGINEERING
539	SE51	PATIL AJINKYA DAYANAND MANISHA	ELECTRICAL ENGINEERING
540	SE52	PATIL AKSHAY JANARDAN ANITA	ELECTRICAL ENGINEERING
541	SE53	/PATIL ANKITA GANPAT NITA	ELECTRICAL ENGINEERING
542	SE54	/PATIL CHETNA BHAGWAN ARCHANA	ELECTRICAL ENGINEERING
543	SE55	PATIL GOKUL RAMESH NANDA	ELECTRICAL ENGINEERING
544	SE56	PATIL HARSHAL KAMLESH RUPALI	ELECTRICAL ENGINEERING
545	SE57	PATIL MINAL MACHHINDRANATH	ELECTRICAL ENGINEERING
546	SE58	PATIL VINAYAK DHONDIBA GEETA	ELECTRICAL ENGINEERING
547	SE59	PAWAR SHUBHAM KASHINATH VANITA	ELECTRICAL ENGINEERING
548	SE60	PENKAR AMIR REFAYAL SARA	ELECTRICAL ENGINEERING
549	SE61	/RAUT VISHAKHA PRABHAKAR PRAJAKTA	ELECTRICAL ENGINEERING
550	SE62	SALUNKE VINAYAK TANAJI NANDA	ELECTRICAL ENGINEERING
551	SE63	SALVE DIKSHA SHASHIKANT RAJANI	ELECTRICAL ENGINEERING
552	SE64	SANKLECHA MAHIL ARAVIND KAVITA	ELECTRICAL ENGINEERING
553	SE65	SHELAR SHUBHAM SANTOSH MANGAL	ELECTRICAL ENGINEERING
554	SE66	SHELKE NILESH VILAS GANGUBAI	ELECTRICAL ENGINEERING
555	SE67	SHINDE AKSHAY DIPAK MANISHA	ELECTRICAL ENGINEERING
556	SE68	SINGH AJEET KUMAR SATISH SUMAN	ELECTRICAL ENGINEERING
557	SE69	TAMBAT SAGAR SHANTARAM VIDYA	ELECTRICAL ENGINEERING

TRUE COPY



[Handwritten Signature]

Principal
Vishwaniketan's (PVT)

558	SE70	TARU JAYESH NAMDEV NAMRATA	ELECTRICAL ENGINEERING
559	SE71	TAYADE SAGAR SHASHIKANT UJJAWALA	ELECTRICAL ENGINEERING
560	SE72	/THAKUR KISHORI SHRIKRISHNA KANCHAN	ELECTRICAL ENGINEERING
561	SE73	TODANKAR KRUNAL CHANDRAKANT SAMIDHA	ELECTRICAL ENGINEERING
562	SE74	WADKE HARSHAL RAMESH RASHMI	ELECTRICAL ENGINEERING
563	SE75	WAGH ANIKET BALU NEETA	ELECTRICAL ENGINEERING
564	SE76	WATWE AKSHAY SUNIL SHALINI	ELECTRICAL ENGINEERING
565	SE77	ZIMBAL KOMAL VASANT SUVARNA	ELECTRICAL ENGINEERING
566	SE78	SINGH AKASH ASHOK ANITA	ELECTRICAL ENGINEERING
567	SE79	SINGH ATHARV BHUPENDRA SUMAN	ELECTRICAL ENGINEERING
568	SE80	SONAR ASHOK DHANSINGH CHANDADEVY	ELECTRICAL ENGINEERING
569	TE1	AWARI ANIL ANANT KAMAL	ELECTRICAL ENGINEERING
570	TE2	BARAI SURAJ JAYPRASAD PRAMILA	ELECTRICAL ENGINEERING
571	TE3	BHADORIYA MANMOHAN SINGH	ELECTRICAL ENGINEERING
572	TE4	/BHOSALE SIDDHI SHARAD JYOTI	ELECTRICAL ENGINEERING
573	TE5	/CHAVAN NEHA MANGESH SANDHYA	ELECTRICAL ENGINEERING
574	TE6	CHAVAN SHRINIVAS RAMCHANDRA	ELECTRICAL ENGINEERING
575	TE7	CHEVALE PRASAD ANIL ASMITA	ELECTRICAL ENGINEERING
576	TE8	DESHMUKH AVINASH PRADIP PRAMILA	ELECTRICAL ENGINEERING
577	TE9	DHAIGUDE PRAMOD BUVASO CHHAYA	ELECTRICAL ENGINEERING
578	TE10	DHONDE SURAJ MARUTI JAYSHREE	ELECTRICAL ENGINEERING
579	TE11	DUBEY YOGESHWAR DEENANATH	ELECTRICAL ENGINEERING
580	TE12	FIRAKE SHUBHAM SHRINIWAS PUSHPA	ELECTRICAL ENGINEERING
581	TE13	/GAIKWAD PRIYANKA BHOURAO JYOTI	ELECTRICAL ENGINEERING
582	TE14	GHANVAT NIKHIL BALU SUREKHA	ELECTRICAL ENGINEERING
583	TE15	/GHOLAP MAYURI ASHOK SANGITA	ELECTRICAL ENGINEERING
584	TE16	HOTKAR AKSHAY ARUN SINDHU	ELECTRICAL ENGINEERING
585	TE17	JADHAV AKSHAY YASHWANT MALATEE	ELECTRICAL ENGINEERING
586	TE18	JADHAV SHUBHAM GAJANAN SANGITA	ELECTRICAL ENGINEERING
587	TE19	KACHARE REVNATH GOPAL GEETA	ELECTRICAL ENGINEERING
588	TE20	KAMTHE AKSHAY NAGESH MANISHA	ELECTRICAL ENGINEERING
589	TE21	KHOT GANESH KESHAV SAKHUTAI	ELECTRICAL ENGINEERING
590	TE22	KONDUSKAR CHANDRAKANT ARUN	ELECTRICAL ENGINEERING
591	TE23	/LANGI SUPRIYA SURESH USHA	ELECTRICAL ENGINEERING
592	TE24	MAHALE ASHWIN ARUN SHOBHA	ELECTRICAL ENGINEERING
593	TE25	MANE RAHUL DHANAJI SHOBHA	ELECTRICAL ENGINEERING
594	TE26	MORE VIKAS SHIVRAM SUSHILA	ELECTRICAL ENGINEERING
595	TE27	NAIR KRISHNAPRASAD MOHAN USHA	ELECTRICAL ENGINEERING
596	TE28	NALAWADE PRATHAMESH ANANDRAW	ELECTRICAL ENGINEERING
597	TE29	NIRAJ MITHLESH GEETA	ELECTRICAL ENGINEERING
598	TE30	OMALE AKSHAY BHIKAJI SUNITA	ELECTRICAL ENGINEERING
599	TE31	PARDESHI SANTOSH JANKIRAM PUSHPA	ELECTRICAL ENGINEERING
600	TE32	PATEKAR BHARAT PANDURANG	ELECTRICAL ENGINEERING
601	TE33	PATIL ANIKET TATOBA SUJATA	ELECTRICAL ENGINEERING
602	TE34	PATIL SATEJ RAMAKANT SARIKA	ELECTRICAL ENGINEERING
603	TE35	PURI SURAJ RAJESH GAYATRI	ELECTRICAL ENGINEERING
604	TE36	RAJPURE PRITAM SAVLARAM CHHAYA	ELECTRICAL ENGINEERING



TRUE COPY

J.P.

Principal

Vishwaniketan (i) MEET

605	TE37	RASAL PRUTHIVIRAJ DINKAR DROPADI	ELECTRICAL ENGINEERING
606	TE38	SALUNKHE PRATHMESH ASHOK VANITA	ELECTRICAL ENGINEERING
607	TE39	SAWANT ANIL DATTATRAY MANGAL	ELECTRICAL ENGINEERING
608	TE40	SAWANT PRATHAMESH MANOJ MEGHANA	ELECTRICAL ENGINEERING
609	TE41	SHELAR ATUL RAMESH SANGEETA	ELECTRICAL ENGINEERING
610	TE42	SHINDE ADITYA UDDHAV SAVITA	ELECTRICAL ENGINEERING
611	TE43	SHINDE SUKANYA SUDHAKAR SUMITRA	ELECTRICAL ENGINEERING
612	TE44	SINGH AKASH ASHOK ANITA	ELECTRICAL ENGINEERING
613	TE45	SINGH ATHARV BHUPENDRA SUMAN	ELECTRICAL ENGINEERING
614	TE46	SONAR ASHOK DHANSINGH CHANDADEV	ELECTRICAL ENGINEERING
615	TE47	TANDEL MANISH BALIRAM KALPANA	ELECTRICAL ENGINEERING
616	TE48	VHARE SAMBHAJI PANDURANG PHULABAI	ELECTRICAL ENGINEERING
617	TE49	WARGUDE VAIBHAV KRUSHNA USHA	ELECTRICAL ENGINEERING
618	SE 01	BHILARE KIRAN MUGUT	ELECTRONICS AND TELECOMMUNICATION
619	SE 02	BHOSALE POONAM RAMESH	ELECTRONICS AND TELECOMMUNICATION
620	SE 03	CHOUGULE GURURAJ CHANDRASHEKHAR	ELECTRONICS AND TELECOMMUNICATION
621	SE 04	DANGE AKSHAY SHIRISHKUMAR	ELECTRONICS AND TELECOMMUNICATION
622	SE 05	DESHMUKH PIYUSH KAILAS	ELECTRONICS AND TELECOMMUNICATION
623	SE 06	DESHMUKH VIRAJ RAJENDRA	ELECTRONICS AND TELECOMMUNICATION
624	SE 07	DESHPANDE PARTH MAKARAND	ELECTRONICS AND TELECOMMUNICATION
625	SE 08	DHIGARE AKSHAY ANADA	ELECTRONICS AND TELECOMMUNICATION
626	SE 09	GADGE MEGHANA ARUN	ELECTRONICS AND TELECOMMUNICATION
627	SE 10	GAUND SURAJ AJIT	ELECTRONICS AND TELECOMMUNICATION
628	SE 11	GHARAT AJIT ARUN	ELECTRONICS AND TELECOMMUNICATION
629	SE 12	GOLE PRANALI ARJUN	ELECTRONICS AND TELECOMMUNICATION
630	SE 13	GONDHALI LAXMIKANT ARUN	ELECTRONICS AND TELECOMMUNICATION
631	SE 14	GONDHALI SWAPNIL DHANAJI	ELECTRONICS AND TELECOMMUNICATION
632	SE 15	GURAV JATIN MAHESH	ELECTRONICS AND TELECOMMUNICATION
633	SE 16	HALDAR SOURADEEP TAPAS	ELECTRONICS AND TELECOMMUNICATION
634	SE 17	HARPUDE VRUSHABH GAJANAN	ELECTRONICS AND TELECOMMUNICATION
635	SE 18	ISHWARE TUSHAR ARVIND	ELECTRONICS AND TELECOMMUNICATION
636	SE 19	JADHAV VISHAL POPAT	ELECTRONICS AND TELECOMMUNICATION
637	SE 20	JANGAM ABHISHEK SHRIKANT	ELECTRONICS AND TELECOMMUNICATION
638	SE 21	KADAM DIPASHRI DILIP	ELECTRONICS AND TELECOMMUNICATION
639	SE 22	KADU BHAKTI VILAS	ELECTRONICS AND TELECOMMUNICATION
640	SE 23	KAVALE KUNAL ASHISH	ELECTRONICS AND TELECOMMUNICATION
641	SE 24	KHARADE SANKET SUNIL	ELECTRONICS AND TELECOMMUNICATION
642	SE 25	KOKAMBE KIRAN BABAN	ELECTRONICS AND TELECOMMUNICATION
643	SE 26	KONT ANUJ ANAND	ELECTRONICS AND TELECOMMUNICATION
644	SE 27	KURANE AARTI RAVINDRA	ELECTRONICS AND TELECOMMUNICATION
645	SE 28	MANDLEKAR ASAVARI ANIL	ELECTRONICS AND TELECOMMUNICATION
646	SE 29	MANE PUNAM JALINDAR	ELECTRONICS AND TELECOMMUNICATION
647	SE 30	MHATRE PRANALI CHANDRAKANT	ELECTRONICS AND TELECOMMUNICATION
648	SE 31	MHATRE SUPRIYA CHANDRAKANT	ELECTRONICS AND TELECOMMUNICATION
649	SE 32	MHATRE VIKRANT DINANATH	ELECTRONICS AND TELECOMMUNICATION
650	SE 33	MOKASHI YASH PRASHANT	ELECTRONICS AND TELECOMMUNICATION
651	SE 34	MORE SURAJ SATISH	ELECTRONICS AND TELECOMMUNICATION

TRUE COPY



Principal
Vishwaniketan's (I MEET)

652	SE 35	NAIK RASHMITA JAYANAND	ELECTRONICS AND TELECOMMUNICATION
653	SE 36	NIKAM DHANASHREE VILAS	ELECTRONICS AND TELECOMMUNICATION
654	SE 37	NIKAM SAGAR MADHUKAR	ELECTRONICS AND TELECOMMUNICATION
655	SE 38	PATIL ABHEET ARVIND	ELECTRONICS AND TELECOMMUNICATION
656	SE 39	PATIL ADITYA DEVIDAS	ELECTRONICS AND TELECOMMUNICATION
657	SE 40	PATIL MANOJ PRADIP	ELECTRONICS AND TELECOMMUNICATION
658	SE 41	PATIL NAMRATA VILAS	ELECTRONICS AND TELECOMMUNICATION
659	SE 42	PATIL NITISH MANOJ	ELECTRONICS AND TELECOMMUNICATION
660	SE 43	PATIL PRIYANKA RAMCHANDRA	ELECTRONICS AND TELECOMMUNICATION
661	SE 44	PAWAR SAI GANESH	ELECTRONICS AND TELECOMMUNICATION
662	SE 45	PINGALE KEDAR SUNIL	ELECTRONICS AND TELECOMMUNICATION
663	SE 46	RAJPURKAR PRATIKSHA KRUSHNA	ELECTRONICS AND TELECOMMUNICATION
664	SE 47	SAHU JANKIDEVI SHIVPRASAD	ELECTRONICS AND TELECOMMUNICATION
665	SE 48	SALVI PRATHAMESH BHASKAR	ELECTRONICS AND TELECOMMUNICATION
666	SE 49	SHINDE SURAJ SANJAY	ELECTRONICS AND TELECOMMUNICATION
667	SE 50	SHRIGIRI KARAN DATTATRAYA	ELECTRONICS AND TELECOMMUNICATION
668	SE 51	SHRIVASTAVA RISHAV ASHOK	ELECTRONICS AND TELECOMMUNICATION
669	SE 52	SHRIVASTAVA SAURABH RAJKUMAR	ELECTRONICS AND TELECOMMUNICATION
670	TE 01	AWALE VISHAL VITTHAL	ELECTRONICS AND TELECOMMUNICATION
671	TE 02	/BHINGARKAR SNEHA DAMAJI	ELECTRONICS AND TELECOMMUNICATION
672	TE 03	/BIRAJDAR SNEHAL HANMANT	ELECTRONICS AND TELECOMMUNICATION
673	TE 04	BHUTAL SAGAR HINDURAM	ELECTRONICS AND TELECOMMUNICATION
674	TE 05	CHAVAN KETAN SARJERAO	ELECTRONICS AND TELECOMMUNICATION
675	TE 06	/DALVI PRANALI PANDURANG	ELECTRONICS AND TELECOMMUNICATION
676	TE 07	DAVLE VILAS MADHUKAR	ELECTRONICS AND TELECOMMUNICATION
677	TE 08	/DAS SNEHA RAJU JAYASHEELA	ELECTRONICS AND TELECOMMUNICATION
678	TE 09	DUBAL AJAY VISHNU	ELECTRONICS AND TELECOMMUNICATION
679	TE 10	DUKARE SANDESH ARUN	ELECTRONICS AND TELECOMMUNICATION
680	TE 11	/GAIKWAD TEJASHRI SADASHIV	ELECTRONICS AND TELECOMMUNICATION
681	TE 12	/GAWAND SUVIDHA SANDIP	ELECTRONICS AND TELECOMMUNICATION
682	TE 13	/GIRAMKAR HARSHADA KAILAS	ELECTRONICS AND TELECOMMUNICATION
683	TE 14	GIRI RAJ SHIVKUMAR	ELECTRONICS AND TELECOMMUNICATION
684	TE 15	JADHAV ANIL PARABATI	ELECTRONICS AND TELECOMMUNICATION
685	TE 16	/JANE MONALI RAJENDRA	ELECTRONICS AND TELECOMMUNICATION
686	TE 17	JOSHI TANMAY VASANT	ELECTRONICS AND TELECOMMUNICATION
687	TE 18	/KARDE MAYURI BABURAO	ELECTRONICS AND TELECOMMUNICATION
688	TE 19	/KHAMBAL SHRADDHA MARUTI	ELECTRONICS AND TELECOMMUNICATION
689	TE 20	KONA SAI DURGAPRASAD	ELECTRONICS AND TELECOMMUNICATION
690	TE 21	KUMBHAR SURAJ SANJAY	ELECTRONICS AND TELECOMMUNICATION
691	TE 22	LOTE AJAY SUNIL	ELECTRONICS AND TELECOMMUNICATION
692	TE 23	/MHATRE EKATA JAYGUN	ELECTRONICS AND TELECOMMUNICATION
693	TE 24	MHATRE SUDIN MORESHWAR	ELECTRONICS AND TELECOMMUNICATION
694	TE 25	PAILWAN SUNNY KUNJAN	ELECTRONICS AND TELECOMMUNICATION
695	TE 26	PAL MAHESHKUMAR PARASNATH	ELECTRONICS AND TELECOMMUNICATION
696	TE 27	PATIL AKSHAY NAMDEV	ELECTRONICS AND TELECOMMUNICATION
697	TE 28	PATIL AKSHAY VITHOBA	ELECTRONICS AND TELECOMMUNICATION
698	TE 29	PATIL DHIRAJ SURESH	ELECTRONICS AND TELECOMMUNICATION



TRUE COPY

[Handwritten Signature]

Principal

Vishwaniketan's (i MEET)

699	TE 30	PATIL MAMATA MADHAV	ELECTRONICS AND TELECOMMUNICATION
700	TE 31	PATIL NEHA BABASAHEB	ELECTRONICS AND TELECOMMUNICATION
701	TE 32	PATIL ROHAN ROHIDAS	ELECTRONICS AND TELECOMMUNICATION
702	TE 33	PATIL SHRADDHA JEEVAN	ELECTRONICS AND TELECOMMUNICATION
703	TE 34	PHADNIS CHINMAY AVINASHI	ELECTRONICS AND TELECOMMUNICATION
704	TE 35	RAM POOJA SUDARSHAN	ELECTRONICS AND TELECOMMUNICATION
705	TE 36	RAUT PRANOTI JAGADISH	ELECTRONICS AND TELECOMMUNICATION
706	TE 37	SINGH SANDEEP RADHESHYAM	ELECTRONICS AND TELECOMMUNICATION
707	TE 38	SINGH SIKHA DINESH	ELECTRONICS AND TELECOMMUNICATION
708	TE 39	TALEKAR MUKESH DEVIDAS	ELECTRONICS AND TELECOMMUNICATION
709	TE 40	THAKUR ROHAN LAXMAN	ELECTRONICS AND TELECOMMUNICATION
710	TE 41	TARDE NIKHIL SUNIL	ELECTRONICS AND TELECOMMUNICATION
711	TE 42	VARMA SAGAR HARISUNDAR	ELECTRONICS AND TELECOMMUNICATION
712	TE 43	VARMA SANJAY RAMKUMAR	ELECTRONICS AND TELECOMMUNICATION
713	TE 44	VINISH VIJAYAN INDIRA	ELECTRONICS AND TELECOMMUNICATION
714	TE 45	WAGIRE SWAPNALI ANIL	ELECTRONICS AND TELECOMMUNICATION
715	TE 46	YADAV MOHAN RAMNIWAS	ELECTRONICS AND TELECOMMUNICATION
716	TE 47	YADAV SHESHNATH RADHASHYAM	ELECTRONICS AND TELECOMMUNICATION
717	TE 48	DESHMUKH SHRADHA UDDHAV	ELECTRONICS AND TELECOMMUNICATION
718	TE 49	POPAT HARSH GIRISH	ELECTRONICS AND TELECOMMUNICATION
719	TE 50	SHINDE SWETA DILIPKUMAR	ELECTRONICS AND TELECOMMUNICATION
720	TE 51	SINGH ARJUN RAJIVLOCHAN	ELECTRONICS AND TELECOMMUNICATION
721	BE 01	BANDGAR JOTIRAM MANOHAR	ELECTRONICS AND TELECOMMUNICATION
722	BE 02	BHAGAT PRATHAMESH LAXMAN	ELECTRONICS AND TELECOMMUNICATION
723	BE 03	BHALERAO BHIMRAO SUNIL	ELECTRONICS AND TELECOMMUNICATION
724	BE 04	BHOSALE VISHAL ARJUN RANJANA	ELECTRONICS AND TELECOMMUNICATION
725	BE 05	CHALKE PRATHAMESH SURESH	ELECTRONICS AND TELECOMMUNICATION
726	BE 06	CHAUHAN AAKASH RAJESH	ELECTRONICS AND TELECOMMUNICATION
727	BE 07	CHAVAN SHUBHAM VIJAY	ELECTRONICS AND TELECOMMUNICATION
728	BE 08	DHALE SUVARNA POPAT	ELECTRONICS AND TELECOMMUNICATION
729	BE 09	DHANE SNEHA RAJENDRA	ELECTRONICS AND TELECOMMUNICATION
730	BE 10	DHEMBARE AKASH HANMANT	ELECTRONICS AND TELECOMMUNICATION
731	BE 11	DHUMAL RAHUL ROHIDAS	ELECTRONICS AND TELECOMMUNICATION
732	BE 12	GHOLAP KAJAL SURESH	ELECTRONICS AND TELECOMMUNICATION
733	BE 13	HANDE SNEHA RAMCHANDRA	ELECTRONICS AND TELECOMMUNICATION
734	BE 14	JAISWAL ARVIND MUSAFIR	ELECTRONICS AND TELECOMMUNICATION
735	BE 15	KADU SWAPNALI BALARAM	ELECTRONICS AND TELECOMMUNICATION
736	BE 16	KHAMBE ANKITA VIJAY	ELECTRONICS AND TELECOMMUNICATION
737	BE 17	KHOT VRUSHALI HANAMANT	ELECTRONICS AND TELECOMMUNICATION
738	BE 18	KOLI HITESH GOVIND	ELECTRONICS AND TELECOMMUNICATION
739	BE 19	MAHADIK PRAJAKTA SHANKAR	ELECTRONICS AND TELECOMMUNICATION
740	BE 20	NIKAM MOHINI PRAKASH	ELECTRONICS AND TELECOMMUNICATION
741	BE 21	PANDEY ALOK GYANPRAKASH	ELECTRONICS AND TELECOMMUNICATION
742	BE 22	RAI RAVI VIRENDRA	ELECTRONICS AND TELECOMMUNICATION
743	BE 23	SHAIKH SOHAIL BABU	ELECTRONICS AND TELECOMMUNICATION
744	BE 24	SHARMA ANKIT SHRIKANT	ELECTRONICS AND TELECOMMUNICATION
745	BE 25	SHINDE SHRUTI SUBHAKAR	ELECTRONICS AND TELECOMMUNICATION



TRUE COPY

[Handwritten Signature]

Vishwaniketan's (I IMET)

746	BE 26	SHIVALE DEEPIKA JANARDAN	ELECTRONICS AND TELECOMMUNICATION
747	BE 27	SINGH SHIVANI SHAILENDER	ELECTRONICS AND TELECOMMUNICATION
748	BE 28	SINGH VIVEKKUMAR HARIOM	ELECTRONICS AND TELECOMMUNICATION
749	BE 29	THAKUR SAYLEE SHYAM	ELECTRONICS AND TELECOMMUNICATION
750	BE 30	TIWARI ANKITKUMAR RAKESHKUMAR	ELECTRONICS AND TELECOMMUNICATION
751	BE 31	TONDE SHARVARI PRAKASHI	ELECTRONICS AND TELECOMMUNICATION
752	BE 32	YADAV SANTOSHKUMAR VIJAYBAHADUR	ELECTRONICS AND TELECOMMUNICATION
753	SEA01	AMBURLE SWAPNIL RAJEEV SUNITA	MECHANICAL ENGINEERING
754	SEA02	ARKE SAGAR BHAUSAHEB REKHA	MECHANICAL ENGINEERING
755	SEA03	BADGUJAR TUSHAR BHALCHANDRA VAISHALI	MECHANICAL ENGINEERING
756	SEA04	BANGAR SAURABH SHIVAJI	MECHANICAL ENGINEERING
757	SEA05	BARSHI ASHISH NARAYAN SUJATA	MECHANICAL ENGINEERING
758	SEA06	AGIWALE NIKET DATTARAM	MECHANICAL ENGINEERING
759	SEA07	CHOUGALE SAMYANTAK SANJAY SANGEETA	MECHANICAL ENGINEERING
760	SEA08	DALVI OMKAR PRAMOD PRANALI	MECHANICAL ENGINEERING
761	SEA09	DAWARE VAIBHAV PRAKASH PRAMILA	MECHANICAL ENGINEERING
762	SEA10	DESHMUKH RATNADEEP RAMCHANDRA ROHINI	MECHANICAL ENGINEERING
763	SEA11	DHAYAL SHREEKUMAR RATANLAL SAJJANA	MECHANICAL ENGINEERING
764	SEA12	DHOPTA VIDYADHAR ARUNKUMAR SEEMA	MECHANICAL ENGINEERING
765	SEA13	GAIKAR SUMEET MANOHAR	MECHANICAL ENGINEERING
766	SEA14	GAIKWAD ANIRUDDHA SUDHIR ARADHANA	MECHANICAL ENGINEERING
767	SEA15	GAJARE ROHAN LAXMAN SANGITA	MECHANICAL ENGINEERING
768	SEA16	GHATTARGI GAURINANDAN LAXMAN PUSHPA	MECHANICAL ENGINEERING
769	SEA17	GHEVDE SAURABH	MECHANICAL ENGINEERING
770	SEA18	GHOSALKAR GAURAV GURUDATTA	MECHANICAL ENGINEERING
771	SEA19	CHAVAN SURAJ SHANTARAM	MECHANICAL ENGINEERING
772	SEA20	DHURE SAURABH VISHNU	MECHANICAL ENGINEERING
773	SEA21	GAIKAR RAKESH RAMESH	MECHANICAL ENGINEERING
774	SEA22	HADAWALE PRATIK KUSHABHAU	MECHANICAL ENGINEERING
775	SEA23	HEGDE SUMANTH SURESH VILASINI	MECHANICAL ENGINEERING
776	SEA24	GAWALI VILAS ARJUN	MECHANICAL ENGINEERING
777	SEA25	JAGDALE ADITYA AJAYKUMAR ADITI	MECHANICAL ENGINEERING
778	SEA26	JANGAM ANIKET SUHAS ANJANA	MECHANICAL ENGINEERING
779	SEA27	JATKAR AYYAZ HUSSAIN AHISHA	MECHANICAL ENGINEERING
780	SEA28	JUIKAR KARANRAJ PRAVIN	MECHANICAL ENGINEERING
781	SEA29	KAMBLE PRANIL DNYANESHWAR SHEETAL	MECHANICAL ENGINEERING
782	SEA30	KHANDAKALE KUNDAN RAMESH GEETA	MECHANICAL ENGINEERING
783	SEA31	BORLE VIRAJ RAMDAS	MECHANICAL ENGINEERING
784	SEA32	KHOT RUSHIKESH HANAMANT BHARATI	MECHANICAL ENGINEERING
785	SEA33	MALI SHUBHAM RAMCHANDRA LATA	MECHANICAL ENGINEERING
786	SEA34	ITHAPE TUSHAR VITTHAL	MECHANICAL ENGINEERING
787	SEA35	MHATRE SANMIT SANTOSH SWATI	MECHANICAL ENGINEERING
788	SEA36	JAUNJAL NAGESH PRADEEP	MECHANICAL ENGINEERING
789	SEA37	PANDHARE AKSHAY MADHUKAR UJAWALA	MECHANICAL ENGINEERING
790	SEA38	PANGRE MOHAN JAYANTA	MECHANICAL ENGINEERING
791	SEA39	PATIL AKSHAY ATUL APARNA	MECHANICAL ENGINEERING
792	SEA40	PATIL ANIKET	MECHANICAL ENGINEERING



TRUE COPY

(Signature)

Principal

Vishwaniketan's (i) MEET

793	SEA41	PATIL KALPESH RAMESH	MECHANICAL ENGINEERING
794	SEA42	PATIL OMKAR ULHAS NEETA	MECHANICAL ENGINEERING
795	SEA43	PATIL RAKESH RAMCHANDRA VANITA	MECHANICAL ENGINEERING
796	SEA44	PATIL SANKET RAMESH UTTARA	MECHANICAL ENGINEERING
797	SEA45	PATIL SHANTANU NITIN MANJUSHA	MECHANICAL ENGINEERING
798	SEA46	MEKALE SACHIN SANJAY	MECHANICAL ENGINEERING
799	SEA47	PAWADE PRIYANKA	MECHANICAL ENGINEERING
800	SEA48	PAWAR PRIYANKA VIJAY AARTI	MECHANICAL ENGINEERING
801	SEA49	PAWAR SURAJ DILIP RESHMA	MECHANICAL ENGINEERING
802	SEA50	PHADTARE SANKET SANJAY NANDA	MECHANICAL ENGINEERING
803	SEA51	RANANAVARE OMKAR GOPAL KESHAR	MECHANICAL ENGINEERING
804	SEA52	MHATRE AKSHAY NAMDEO	MECHANICAL ENGINEERING
805	SEA53	SALE SWARNIL SANJAY ANJALI	MECHANICAL ENGINEERING
806	SEA54	SALVI RUSHIKESH MAHENDRA MOHINI	MECHANICAL ENGINEERING
807	SEA55	SAPRE MAYURESH MAHENDRA KALYANI	MECHANICAL ENGINEERING
808	SEA56	SARNAIK SUSHIL HINDURAO	MECHANICAL ENGINEERING
809	SEA57	SINGH KARANPREET RAJINDERSINGH HARPALKAUR	MECHANICAL ENGINEERING
810	SEA58	SUGANDHI RAJEEV KISHORE RICHA	MECHANICAL ENGINEERING
811	SEA59	THAKUR RUSHIKESH RAMESH	MECHANICAL ENGINEERING
812	SEA60	GAIKWAD SANGRAM SHIVAJI	MECHANICAL ENGINEERING
813	SEA61	THALE PRIYAJ PRAKASH LALITA	MECHANICAL ENGINEERING
814	SEA62	VEER TUSHAR CHANGDEO SUVARNA	MECHANICAL ENGINEERING
815	SEA63	VISHWAKARMA SACHHIDANAND RAMHARSH MANJU	MECHANICAL ENGINEERING
816	SEA64	WANI NAYAN RAJENDRA SARITA	MECHANICAL ENGINEERING
817	SEA65	WARDE SACHIN SHANTARAM ANITA	MECHANICAL ENGINEERING
818	SEA66	WARE VISHAL MAHADEV NANDA	MECHANICAL ENGINEERING
819	SEA67	YADAV SUDHIRKUMAR RAMSHARAN	MECHANICAL ENGINEERING
820	SEA68	NEVAREKAR NIMISH HEMKANT	MECHANICAL ENGINEERING
821	SEA69	PATIL OMKAR BHASKAR	MECHANICAL ENGINEERING
822	SEA70	PATIL SONALI EKANATH	MECHANICAL ENGINEERING
823	SEA71	RASAL TEJESH SATISH	MECHANICAL ENGINEERING
824	SEA72	SALVE SAMEER DATTA	MECHANICAL ENGINEERING
825	SEA73	SANAP PARMESHWAR SUKDEV	MECHANICAL ENGINEERING
826	SEA74	SAYYED KAMRAN ASIF	MECHANICAL ENGINEERING
827	SEA75	THAKUR DILIP KISHOR	MECHANICAL ENGINEERING
828	SEA76	THAKUR SIDDHESH JANARDHAN	MECHANICAL ENGINEERING
829	SEA77	VIDHATE HIMALAY JAYANT	MECHANICAL ENGINEERING
830	SEA78	LOKHANDE DHANANJAY DEVIDAS	MECHANICAL ENGINEERING
831	SEB01	AJAGEKAR PRATIK ANANDA SANGITA	MECHANICAL ENGINEERING
832	SEB02	AUTI VISHAL JALINDAR SUNITA	MECHANICAL ENGINEERING
833	SEB03	AMBATE SACHINREDDI NARSAREDDI	MECHANICAL ENGINEERING
834	SEB04	BHOSALE VIPUL SANJAY SANGEETA	MECHANICAL ENGINEERING
835	SEB05	CHAVAN SAURABH SURESH BHARATI	MECHANICAL ENGINEERING
836	SEB06	CHOUDHARY RAKESH BHAWARLAL VIJLA	MECHANICAL ENGINEERING
837	SEB07	DHUMAL SAURABH NAMDEV NILIMA	MECHANICAL ENGINEERING
838	SEB08	DWIVEDI KARAN RAJENDRA RAMSAKHI	MECHANICAL ENGINEERING
839	SEB09	UGALMUGALE SANTOSH PANDURANG	MECHANICAL ENGINEERING

TRUE COPY



[Handwritten Signature]

Principal
Vishwaniketan's (i) MEET

840	SEB10	BHAVSAR VEDANT UMESH	MECHANICAL ENGINEERING
841	SEB11	GUNJAL AKSHAY	MECHANICAL ENGINEERING
842	SEB12	JADHAV ABHISHEK GANPAT SUSHAMA	MECHANICAL ENGINEERING
843	SEB13	JADHAV ASHOK GANGADHAR MANISHA	MECHANICAL ENGINEERING
844	SEB14	JADHAV NIKHIL RAJENDRA SHOBHA	MECHANICAL ENGINEERING
845	SEB15	JAMBHALE MAYUR NATHURAM NANDA	MECHANICAL ENGINEERING
846	SEB16	JAMBHALIKAR ATUL ASHOK PRATIBHA	MECHANICAL ENGINEERING
847	SEB17	JUJKAR MITESH JANARDAN SANGITA	MECHANICAL ENGINEERING
848	SEB18	KARANDE TEJAS DAJI MANISHA	MECHANICAL ENGINEERING
849	SEB19	CHALVADI VIVEK VANRAJ	MECHANICAL ENGINEERING
850	SEB20	CHAUDHARI HARSHAL RAJENDRA	MECHANICAL ENGINEERING
851	SEB21	CHIRNERKAR ABHIJIT NANDKUMAR	MECHANICAL ENGINEERING
852	SEB22	KUTE SHUBHAM SADANAND UJWALA	MECHANICAL ENGINEERING
853	SEB23	GAIKAR AKSHAY YASHWANT	MECHANICAL ENGINEERING
854	SEB24	MHATRE JAYESH VISHWANATH SHUBHANGI	MECHANICAL ENGINEERING
855	SEB25	MHATRE PRATIK DATTARAM PRIYA	MECHANICAL ENGINEERING
856	SEB26	MHATRE PRATIK PRAKASH ANJANI	MECHANICAL ENGINEERING
857	SEB27	VALIMBE KAMALAKAR MORESHWAR	MECHANICAL ENGINEERING
858	SEB28	GORAD VISHAL BHIMRAO	MECHANICAL ENGINEERING
859	SEB29	GURAV PRANAV HEMANT	MECHANICAL ENGINEERING
860	SEB30	JADHAV AVINASH BALKRISHNA	MECHANICAL ENGINEERING
861	SEB31	JADHAV NILESH RAJARAM	MECHANICAL ENGINEERING
862	SEB32	JAGTAP ABHISHEK DADASAHEB	MECHANICAL ENGINEERING
863	SEB33	KAMAT SHANKNIL SATISH	MECHANICAL ENGINEERING
864	SEB34	NAIK SHUBHANKAR PRAVIN SHACHI	MECHANICAL ENGINEERING
865	SEB35	NALAWADE AKSHAY KISAN	MECHANICAL ENGINEERING
866	SEB36	KHARAT AKSHAY ANNA	MECHANICAL ENGINEERING
867	SEB37	PAGAR SHANTANU VIJAY ANITA	MECHANICAL ENGINEERING
868	SEB38	LAD SANDESH VILAS	MECHANICAL ENGINEERING
869	SEB39	PARAB TUSHAR VIJAY VIJAYA	MECHANICAL ENGINEERING
870	SEB40	PATIL SAURABH	MECHANICAL ENGINEERING
871	SEB41	PATIL PRANIT NARAYAN GULAB	MECHANICAL ENGINEERING
872	SEB42	PATIL SARVESH SURESH SARITA	MECHANICAL ENGINEERING
873	SEB43	MOHAPE PRAJYOT HANUMANT	MECHANICAL ENGINEERING
874	SEB44	PATIL SURAJ DHANAJI ANITA	MECHANICAL ENGINEERING
875	SEB45	POWAR TUSHAR SHRIPATI MANGAL	MECHANICAL ENGINEERING
876	SEB46	PRAJAPATI RAMBABU DAYASHANKAR	MECHANICAL ENGINEERING
877	SEB47	KHATALE DEEPAK BABLING	MECHANICAL ENGINEERING
878	SEB48	PATIL BHAVESH NARDAS	MECHANICAL ENGINEERING
879	SEB49	PATIL DIVYANK NANDAKUMAR	MECHANICAL ENGINEERING
880	SEB50	SALUNKE HRUSHIKESH BHARATBHUSHAN	MECHANICAL ENGINEERING
881	SEB51	PAWAR ROHAN SANTOSH	MECHANICAL ENGINEERING
882	SEB52	SAMSON STEPHION	MECHANICAL ENGINEERING
883	SEB53	SARUK RAHUL SHESHERAO RADHABAI	MECHANICAL ENGINEERING
884	SEB54	SHAIKH SAHEB MOIN RESHMA	MECHANICAL ENGINEERING
885	SEB55	SHINDE GANESH RAMCHANDRA MANISHA	MECHANICAL ENGINEERING
886	SEB56	SHIROLE SAGAR SHAHAJI SUJATA	MECHANICAL ENGINEERING



TRUE COPY

[Handwritten Signature]

Principal

Vishwaniketan's (i MEET)

887	SEB57	SHIVHARE ABHISHEK ROHIDAS RUPALI	MECHANICAL ENGINEERING
888	SEB58	SINGH AMIT TEJ BAHADUR MANJU	MECHANICAL ENGINEERING
889	SEB59	SINGH CHANDAN SHAMBHU PRAMILA	MECHANICAL ENGINEERING
890	SEB60	SOLKAR MOHAMMADSAROSH KABIL MARIYA	MECHANICAL ENGINEERING
891	SEB61	SOLSE AJAY ROHIDAS SUNITA	MECHANICAL ENGINEERING
892	SEB62	SONAWALE SUYOG DATTATRAY SUVARNA	MECHANICAL ENGINEERING
893	SEB63	RAWOOL AKSHAY ANAND	MECHANICAL ENGINEERING
894	SEB64	SURVE DHIRAJ SUDHARANG SAVITA	MECHANICAL ENGINEERING
895	SEB65	SURVE SHIVAM RAJESH RUPESHA	MECHANICAL ENGINEERING
896	SEB66	THAKUR ABHJEET SHRIKANT AMITA	MECHANICAL ENGINEERING
897	SEB67	THAKUR SUYOG GANGADHAR	MECHANICAL ENGINEERING
898	SEB68	THAKUR SANKET PRAKASH	MECHANICAL ENGINEERING
899	SEB69	SHEMBADE AKSHAYKUMAR MARUTI	MECHANICAL ENGINEERING
900	SEB70	SHET HARSHAL CHANDRAKANT	MECHANICAL ENGINEERING
901	SEB71	WADHAVE AKASH PRAKASH SUNITA	MECHANICAL ENGINEERING
902	SEB72	KANU RESHMA	MECHANICAL ENGINEERING
903	SEB73	RATHOD MAHESH RAM	MECHANICAL ENGINEERING
904	SEB74	PARINGE SHRIKANT MARUTI	MECHANICAL ENGINEERING
905	SEB75	VAISHAMPAYAN HRISHI SHRIKANT	MECHANICAL ENGINEERING
906	SEB76	UPASE SWAPNIL VAIJANATH	MECHANICAL ENGINEERING
907	TEA03	AMALE AKSHAY SURESH	MECHANICAL ENGINEERING
908	TEA05	AROTE PARESH BABAN	MECHANICAL ENGINEERING
909	TEA06	AUSARMAL AJIT ATMARAM SHOBHA	MECHANICAL ENGINEERING
910	TEA07	BAGAL AKSHAY MOHAN	MECHANICAL ENGINEERING
911	TEA08	BAGAL MAHESH NAMDEO	MECHANICAL ENGINEERING
912	TEA09	BAMANKAR MANJUSH PRAVIN	MECHANICAL ENGINEERING
913	TEA10	BHAGAT NIKHIL SANJAY	MECHANICAL ENGINEERING
914	TEA12	BHARATI NANDAN LALLAN	MECHANICAL ENGINEERING
915	TEA13	BHOIR MONISH BHAGURAM SANGITA	MECHANICAL ENGINEERING
916	TEA14	BHOSALE ABHISHEK SHIVAJI	MECHANICAL ENGINEERING
917	TEA15	BORHADE HARSHAD DASHRATH MANISHA	MECHANICAL ENGINEERING
918	TEA16	CHAKRVORTY RAJDEEP DEEPAK	MECHANICAL ENGINEERING
919	TEA17	CHALKE RACHANA DINESH	MECHANICAL ENGINEERING
920	TEA19	CHAUHAN DHIRAJ SARVJEET	MECHANICAL ENGINEERING
921	TEA21	CHAVARKAR PALASH MILIND	MECHANICAL ENGINEERING
922	TEA22	CHOUDHARY RAMESH DINESH	MECHANICAL ENGINEERING
923	TEA23	CHOUGLE SUHAIL MOHAMMED SHAFI	MECHANICAL ENGINEERING
924	TEA25	DEO NIKHIL NARENDRA	MECHANICAL ENGINEERING
925	TEA27	DHANGAR PRATHAMESH RAJENDRA SANGEETA	MECHANICAL ENGINEERING
926	TEA28	DHANSE MUZAMMIL MOHAMMAD RAFIQUE	MECHANICAL ENGINEERING
927	TEA29	DOKE SANDESH SUKHDEV	MECHANICAL ENGINEERING
928	TEA30	ERANDE SHUBHAM SANJAY	MECHANICAL ENGINEERING
929	TEA31	FANASKAR TABISH ANIS	MECHANICAL ENGINEERING
930	TEA33	GAIKWAD KUNAL HEMANT	MECHANICAL ENGINEERING
931	TEA35	GHOSALKAR SAHIL SUNIL SMITA	MECHANICAL ENGINEERING
932	TEA36	GORULE PRANAV SHIVAJI	MECHANICAL ENGINEERING
933	TEA37	GUNAGI NIKHIL BALKRISHNA	MECHANICAL ENGINEERING



TRUE COPY

[Handwritten Signature]

Principal
Mehwan Ketan's (I MEET)

934	TEA38	GUNJAL GANESH KAILAS SANGITA	MECHANICAL ENGINEERING
935	TEA39	GUPTA KRISHNA RAJENDRA	MECHANICAL ENGINEERING
936	TEA40	HATAGADE PRIYANKA VINAYAK	MECHANICAL ENGINEERING
937	TEA43	JADHAV ANIKET BHAGWAN	MECHANICAL ENGINEERING
938	TEA44	JADHAV SAHIL GHANSHYAM	MECHANICAL ENGINEERING
939	TEA45	JAGDALE KOMAL SAMPATRAO VAISHALI	MECHANICAL ENGINEERING
940	TEA46	JAGDALE AMIT MOHAN	MECHANICAL ENGINEERING
941	TEA47	JAGTAP PUNIT VIJAY	MECHANICAL ENGINEERING
942	TEA48	JAISWAR ARUNKUMAR SHAYMDHANI	MECHANICAL ENGINEERING
943	TEA50	JAMBHALE HITESH ANIL	MECHANICAL ENGINEERING
944	TEA51	JAMBHALE RAHUL BALARAM	MECHANICAL ENGINEERING
945	TEA52	JILANI SAHID MUKHTAR	MECHANICAL ENGINEERING
946	TEA53	JORI VISHAL MACHINDRA	MECHANICAL ENGINEERING
947	TEA54	JORWEKAR AKSHAY ASHOK	MECHANICAL ENGINEERING
948	TEA55	KADAM ABHISHEK KRISHNAT CHANDNA	MECHANICAL ENGINEERING
949	TEA57	KAKADE SHUBHAM ANIL	MECHANICAL ENGINEERING
950	TEA59	KALE HEMANTKUMAR GANESH	MECHANICAL ENGINEERING
951	TEA60	KANGE PRITI PANDHRINATH	MECHANICAL ENGINEERING
952	TEA61	KHARAT PRATHAMESH BALKRISHNA LATA	MECHANICAL ENGINEERING
953	TEA62	KHARIVALE NIKESH BALIRAM PRAMILA	MECHANICAL ENGINEERING
954	TEA63	KHEDEKAR PRATHAMESH CHANDRKANT	MECHANICAL ENGINEERING
955	TEA65	KONDASKAR MANISH P.	MECHANICAL ENGINEERING
956	TEA66	KORI SURAJ RAMMILAN SITA	MECHANICAL ENGINEERING
957	TEA67	KOTIAN TEJAS RAVINDRANATH	MECHANICAL ENGINEERING
958	TEA68	KULKARNI NITIN NAGESH	MECHANICAL ENGINEERING
959	TEA69	KUMBHAR SACHIN RAM TARA	MECHANICAL ENGINEERING
960	TEA70	LALGE VAIBHAV GAJENDRA	MECHANICAL ENGINEERING
961	TEA71	LOMTE VISHAL PANDURANG	MECHANICAL ENGINEERING
962	TEA72	MAHADIK SUKLAP DEEPAK	MECHANICAL ENGINEERING
963	TEA73	MAHANGARE ABHILASHA LAXMAN	MECHANICAL ENGINEERING
964	TEA74	MANDE POONAM KAMALAKAR	MECHANICAL ENGINEERING
965	TEA75	MASKE BUDDHABHUSHAN SANTOSH VANITA	MECHANICAL ENGINEERING
966	TEA76	AMRALE PRATEEK	MECHANICAL ENGINEERING
967	TEA77	ANSARE DANISH	MECHANICAL ENGINEERING
968	TEA78	BANDAL VISHAL	MECHANICAL ENGINEERING
969	TEA79	BHANDARI AKASH	MECHANICAL ENGINEERING
970	TEA81	GOLAM PRATEEK	MECHANICAL ENGINEERING
971	TEA82	HALPATRAO DARSHAN	MECHANICAL ENGINEERING
972	TEA85	SAYYED JAVED	MECHANICAL ENGINEERING
973	TEA86	KADAM ASHISH	MECHANICAL ENGINEERING
974	TEA89	PANMAD AJAY	MECHANICAL ENGINEERING
975	TEA90	PATIL MAHESH	MECHANICAL ENGINEERING
976	TEA91	PATIL MANISH	MECHANICAL ENGINEERING
977	TEA92	PAWAR ROHAN	MECHANICAL ENGINEERING
978	TEA93	RAUT SUMIT	MECHANICAL ENGINEERING
979	TEB01	MATHE OMKAR SUBHASH	MECHANICAL ENGINEERING
980	TEB02	MHATRE ABHISHEK JANARDAN	MECHANICAL ENGINEERING

TRUE COPY



[Signature]
Principal
Vishwaniketan's (I) MEET

981	TEB03	MHATRE DHANJAYRAO MACHINDRNATH	MECHANICAL ENGINEERING
982	TEB04	MILATRE GAURAV JANARDAN	MECHANICAL ENGINEERING
983	TEB05	MHATRE NITIN BHAGAVAN VANDANA	MECHANICAL ENGINEERING
984	TEB06	MHATARE RUSHIKESH VISHWANATH	MECHANICAL ENGINEERING
985	TEB07	MISHRA ADARSH RAJESH	MECHANICAL ENGINEERING
986	TEB08	MOHITE SHRIPAD SHRIKANT SHOBHA	MECHANICAL ENGINEERING
987	TEB09	MORE ANIKET BHAGWAN	MECHANICAL ENGINEERING
988	TEB10	MORE ATUL BABAJI CHANDRABHAGA	MECHANICAL ENGINEERING
989	TEB11	MORE YOGESH BALKRISHNA VIMAL	MECHANICAL ENGINEERING
990	TEB12	MUNDHE PRAVIN RAMCHANDRA	MECHANICAL ENGINEERING
991	TEB13	NAKHAWA SHREYAS SHRIKANT	MECHANICAL ENGINEERING
992	TEB14	NARUTE VAIBHAV RAMDAS	MECHANICAL ENGINEERING
993	TEB15	NAVIK KANHAIYA LUTTUR SHANTIDEVI	MECHANICAL ENGINEERING
994	TEB16	NEMANE SHUBHAM SANJAY	MECHANICAL ENGINEERING
995	TEB17	PANDIT SIDDHESH GURUNATH SNEHAL	MECHANICAL ENGINEERING
996	TEB18	PATEKAR ANIKET ABHIMAN MEENA	MECHANICAL ENGINEERING
997	TEB19	PATHAK ANISH ATUL	MECHANICAL ENGINEERING
998	TEB20	PATHAK HIMANSHU RAJESH	MECHANICAL ENGINEERING
999	TEB21	PATHARE MALHAR MAHENDRA	MECHANICAL ENGINEERING
1000	TEB22	PATIL AADESH JAGADISH	MECHANICAL ENGINEERING
1001	TEB23	PATIL ADITYA DNYANESHWAR PRATIBHA	MECHANICAL ENGINEERING
1002	TEB24	PATIL NIKHIL NARAYAN ASHA	MECHANICAL ENGINEERING
1003	TEB25	PATIL PRANIT VINIT	MECHANICAL ENGINEERING
1004	TEB26	PATIL PRASAD LAXMAN	MECHANICAL ENGINEERING
1005	TEB27	PATIL SARVESH VIKAS	MECHANICAL ENGINEERING
1006	TEB28	PATIL VIRAJ MOTIRAM	MECHANICAL ENGINEERING
1007	TEB29	PAWAR AKSHAY AKARAM	MECHANICAL ENGINEERING
1008	TEB30	PISAL YUVRAJ SHIVAJIRAO	MECHANICAL ENGINEERING
1009	TEB31	RAJBHAR RAHUL BANSURAM	MECHANICAL ENGINEERING
1010	TEB32	RAJPUT SONU BHARATSINGH	MECHANICAL ENGINEERING
1011	TEB33	RANSING ABHIJEET VIJAY SHUBHANGI	MECHANICAL ENGINEERING
1012	TEB34	RATHOD MAHESH SHETTY MANJU	MECHANICAL ENGINEERING
1013	TEB35	RATHOD RAHUL MARUTI LATA	MECHANICAL ENGINEERING
1014	TEB36	RATHOUR VIJAY KHEMRAJ	MECHANICAL ENGINEERING
1015	TEB37	RUPNAR SAGAR TUKARAM	MECHANICAL ENGINEERING
1016	TEB38	SAHU SHRIDHAR BANSIDHAR	MECHANICAL ENGINEERING
1017	TEB39	SATANE PRAFULA BALARAM MANISHA	MECHANICAL ENGINEERING
1018	TEB40	SAWANT NIKHIL JANARDN	MECHANICAL ENGINEERING
1019	TEB41	SHAHANE AAKASH GANESH GEETA	MECHANICAL ENGINEERING
1020	TEB42	SHAIKH MUDASSIR BASHIR	MECHANICAL ENGINEERING
1021	TEB43	SHINDE PRADIP SUBHASH	MECHANICAL ENGINEERING
1022	TEB44	SINGH PREMKUMAR RAMPRATAP	MECHANICAL ENGINEERING
1023	TEB45	SONI PRASHANT D.	MECHANICAL ENGINEERING
1024	TEB46	SURYAWANSHI AKSHAYKUMAR LAXMAN	MECHANICAL ENGINEERING
1025	TEB47	SYED ARMAAN ABRAR GAZALA	MECHANICAL ENGINEERING
1026	TEB48	TAMBRE YOGESHWAR RAJESH VIJAYA	MECHANICAL ENGINEERING
1027	TEB49	TEMGHARE SHUBHAM NARAYAN	MECHANICAL ENGINEERING



TRUE COPY

[Handwritten Signature]

Principal
Vishwanathan's (i)NEET

1028	TEB50	THAKUR SUJIT TILAKRAJ	MECHANICAL ENGINEERING
1029	TEB51	THORAT SHUBHAM SHIVAJI VANITA	MECHANICAL ENGINEERING
1030	TEB52	THOSAR PANKAJ TANAJI NALINI	MECHANICAL ENGINEERING
1031	TEB53	UDUGADE VIJAY TANAJI SUVARNA	MECHANICAL ENGINEERING
1032	TEB54	WADE SANJAY RAJENDRA SUREKHA	MECHANICAL ENGINEERING
1033	TEB55	WADKAR VIVEK NAMDEO	MECHANICAL ENGINEERING
1034	TEB56	WAGH NIKHIL DADAJI	MECHANICAL ENGINEERING
1035	TEB57	WAGHARE SHIVAM SUNIL VIDYA	MECHANICAL ENGINEERING
1036	TEB58	YADAV ABHISHEK MAHESH MAYURI	MECHANICAL ENGINEERING
1037	TEB59	YADAV AJAY HARERAM	MECHANICAL ENGINEERING
1038	TEB60	YADAV RAKESH MUNNALAL	MECHANICAL ENGINEERING
1039	TEB61	YADAV ROHAN SUDHAKAR	MECHANICAL ENGINEERING
1040	TEB62	YADAV VIMLESH MUNARAMA	MECHANICAL ENGINEERING
1041	TEB63	SINGH NITIN	MECHANICAL ENGINEERING
1042	TEB64	SURYAWENSHI OMKAR	MECHANICAL ENGINEERING
1043	TEB65	TAWADE SHIVTEJ	MECHANICAL ENGINEERING
1044	TEB66	VARDHAVE AKSHAY	MECHANICAL ENGINEERING
1045	TEB67	VARADE ROMIL	MECHANICAL ENGINEERING
1046	TEB68	CHAUDHARI AKSHAY PRAKASH	MECHANICAL ENGINEERING
1047	TEB69	GHARAT ROHIT	MECHANICAL ENGINEERING
1048	TEB70	HASALKAR DATTATRAY	MECHANICAL ENGINEERING
1049	TEB71	JADHAV SAMEER	MECHANICAL ENGINEERING
1050	TEB72	MHATRE RITESH	MECHANICAL ENGINEERING
1051	TEB73	PANCHAL ADITYA	MECHANICAL ENGINEERING
1052	TEB74	PATIL DHANRAJ	MECHANICAL ENGINEERING
1053	TEB75	DANGAR RUNIT	MECHANICAL ENGINEERING
1054	BEA01	BHAGAT TUSHAR TUNGANATH	MECHANICAL ENGINEERING
1055	BEA02	BHATIA HARMANDAR MAHIPAL	MECHANICAL ENGINEERING
1056	BEA03	DAWANDE SUMEDH BHARAT	MECHANICAL ENGINEERING
1057	BEA04	FALEBHAY JAY NIVRUTTI	MECHANICAL ENGINEERING
1058	BEA05	GHASE OMKAR BHARAT	MECHANICAL ENGINEERING
1059	BEA06	GAIKWAD ABHIJEET KHANDERAO	MECHANICAL ENGINEERING
1060	BEA07	GAJARE BHUSHAN NATHU	MECHANICAL ENGINEERING
1061	BEA08	GAJARE PRATIK LAXMAN	MECHANICAL ENGINEERING
1062	BEA09	GUPTA ABHISHEK SHIVPRAKASH	MECHANICAL ENGINEERING
1063	BEA10	INGOLE DEEPAK PANDURANG	MECHANICAL ENGINEERING
1064	BEA11	JADHAV ANIKET GANGADHAR	MECHANICAL ENGINEERING
1065	BEA12	JAISWAL RAHUL SURENDRANATH	MECHANICAL ENGINEERING
1066	BEA13	JUIKAR SOHAM SANJAY	MECHANICAL ENGINEERING
1067	BEA14	KADAM PRASHANT SHANKAR	MECHANICAL ENGINEERING
1068	BEA15	KANK ARUN SITARAM	MECHANICAL ENGINEERING
1069	BEA16	KANNAUJIYA SURAJLAL MAHADEVVAL	MECHANICAL ENGINEERING
1070	BEA17	KHAN WAKAR KHALILULLAH	MECHANICAL ENGINEERING
1071	BEA18	KHANDEKAR VINAYAK SUNIL	MECHANICAL ENGINEERING
1072	BEA19	KHOT MOHAMMADARIF AJIM	MECHANICAL ENGINEERING
1073	BEA20	KULKARNI AKSHAY VIVEK	MECHANICAL ENGINEERING
1074	BEA21	KURMI SAURAV SHAMBHU	MECHANICAL ENGINEERING

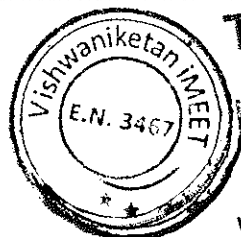

TRUE COPY

[Signature]
Principal
Vishwaniketan's (i) MEET

1075	BEA22	MAHALE RISHABH BHARAT	MECHANICAL ENGINEERING
1076	BEA23	MALI SANKET RAMCHANDRA	MECHANICAL ENGINEERING
1077	BEA24	MANE VAIBHAV SOPAN	MECHANICAL ENGINEERING
1078	BEA25	MANKAR DHRUV RAVI	MECHANICAL ENGINEERING
1079	BEA26	MAURYA ANKIT DAYASHANKAR	MECHANICAL ENGINEERING
1080	BEA27	MENDADKA GAJENDRA PADMAKAR	MECHANICAL ENGINEERING
1081	BEA28	MOMIN MOHD ARHAM JAMEEL A	MECHANICAL ENGINEERING
1082	BEA29	NANDE SOHAM SUNIL	MECHANICAL ENGINEERING
1083	BEA30	PAL RAMESHCHANDRA RAJPATI	MECHANICAL ENGINEERING
1084	BEA31	PATEL DHAGASH BHARAT	MECHANICAL ENGINEERING
1085	BEA32	PATEL NARAYANLAL KAPOORBHAI	MECHANICAL ENGINEERING
1086	BEA33	PATHAN YASEEN PEERKHAN	MECHANICAL ENGINEERING
1087	BEA34	PATIL DIPAK VITTHAL	MECHANICAL ENGINEERING
1088	BEA35	PATIL PRAMOD ARUN	MECHANICAL ENGINEERING
1089	BEA36	PAWAR ABHIJIT SHASHIKANT	MECHANICAL ENGINEERING
1090	BEA37	RODRIGUES VINAYVIVIAN PEDRICK	MECHANICAL ENGINEERING
1091	BEA38	SAHOTA AKASHDEEP SINGH C.S.	MECHANICAL ENGINEERING
1092	BEA39	SAKPAL RAHUL RAJESH	MECHANICAL ENGINEERING
1093	BEA40	SALUNKE ATUL SURESH	MECHANICAL ENGINEERING
1094	BEA41	SARVADE KARAN CHANDRAKANT	MECHANICAL ENGINEERING
1095	BEA42	SHAH AKRAM HUSSAIN K.H.	MECHANICAL ENGINEERING
1096	BEA43	SHELKE SUJIT RAJENDRA	MECHANICAL ENGINEERING
1097	BEA44	SHENDAGE SURYAKANT SANJAY	MECHANICAL ENGINEERING
1098	BEA45	SINGH GURAV RAVIINDAR	MECHANICAL ENGINEERING
1099	BEA46	SINGH LAXMAN GHISU	MECHANICAL ENGINEERING
1100	BEA47	TRIVEDI UTKARSH MUKESH	MECHANICAL ENGINEERING
1101	BEA48	VAIDYA PUSHKARAKSHA SHRIKANT	MECHANICAL ENGINEERING
1102	BEA49	WETKOLI BHARAT BALOJI	MECHANICAL ENGINEERING
1103	BEA50	YADAV JITESHKUMAR S.	MECHANICAL ENGINEERING
1104	BEA51	BOBADE NIKHIL SURESH	MECHANICAL ENGINEERING
1105	BEA52	PAWAR PRUTHVIRAJ MUGATRAO	MECHANICAL ENGINEERING
1106	BEB01	BARAI JITENDRA RAMNATH	MECHANICAL ENGINEERING
1107	BEB02	BHOIR SAGAR NATHURAM	MECHANICAL ENGINEERING
1108	BEB03	BHOSALE KISHOR RAMESH	MECHANICAL ENGINEERING
1109	BEB05	CHAVAN AKSHAY SUNIL	MECHANICAL ENGINEERING
1110	BEB06	CHOUDHARI AKSHAY NANDKUMAR	MECHANICAL ENGINEERING
1111	BEB07	DEVGHARE TEJAS BHARAT	MECHANICAL ENGINEERING
1112	BEB08	DURATE PRATIK CHANDRAKANT	MECHANICAL ENGINEERING
1113	BEB09	FARAD SURAJ SURESH	MECHANICAL ENGINEERING
1114	BEB10	GADE SWAPNIL GURUNATH	MECHANICAL ENGINEERING
1115	BEB11	GAIKWAD SURAJ MANOHAR	MECHANICAL ENGINEERING
1116	BEB12	GHARAT SANKET SURESH	MECHANICAL ENGINEERING
1117	BEB13	GUPTA MANOJKUMAR RAMJIT	MECHANICAL ENGINEERING
1118	BEB14	GURAV SWAPNIL ASHOK	MECHANICAL ENGINEERING
1119	BEB15	KASHYAP ANAND TEJBAHADUR	MECHANICAL ENGINEERING
1120	BEB16	KEDARI PANKAJ SANTOSH	MECHANICAL ENGINEERING
1121	BEB17	KHANDEKAR PANKAJ RAJARAM	MECHANICAL ENGINEERING

TRUE COPY



[Handwritten Signature]
Principal

Vishwaniketan's (I MEET)

1122	BEB18	MAHADIK VAIBHAV SANJAY	MECHANICAL ENGINEERING
1123	BEB19	MALI AJAY KRISHNA	MECHANICAL ENGINEERING
1124	BEB20	MALUSARE RAHUL HANUMANT	MECHANICAL ENGINEERING
1125	BEB21	MANE PRANAV VISHNU	MECHANICAL ENGINEERING
1126	BEB22	MISHRA ASHISH DILIP	MECHANICAL ENGINEERING
1127	BEB23	NAIK SANKET SUNIL	MECHANICAL ENGINEERING
1128	BEB24	NAIKWADE MAYURESH MOTILAL	MECHANICAL ENGINEERING
1129	BEB25	NARAWADE NILESH BABAJI	MECHANICAL ENGINEERING
1130	BEB26	OMALE SUNNY SHIVAJI	MECHANICAL ENGINEERING
1131	BEB27	PATEL DHAIRYA DAMJI	MECHANICAL ENGINEERING
1132	BEB28	PATIL ABHISHEK RAJENDRA	MECHANICAL ENGINEERING
1133	BEB29	PATIL AMIT DAGADOO	MECHANICAL ENGINEERING
1134	BEB30	PATIL KAMLESH RAJENDRA	MECHANICAL ENGINEERING
1135	BEB32	POTE KETAN SHARAD	MECHANICAL ENGINEERING
1136	BEB33	RAJBHAR KISHAN LALJI	MECHANICAL ENGINEERING
1137	BEB34	RAJPUROHIT MAHIPAL DASRATSINGH	MECHANICAL ENGINEERING
1138	BEB35	RAUT BHUSHAN KRISHNA	MECHANICAL ENGINEERING
1139	BEB36	ROKADE PAVAN SUNIL	MECHANICAL ENGINEERING
1140	BEB37	SHAIKH SHADAB ALI AZAM	MECHANICAL ENGINEERING
1141	BEB38	SHELAR OMKAR SADANAND	MECHANICAL ENGINEERING
1142	BEB39	SHEWALE SANTOSH SHAHAJI	MECHANICAL ENGINEERING
1143	BEB40	SHINDE AJAY PPRAKASH	MECHANICAL ENGINEERING
1144	BEB41	SHINDE AKSHAYRAJ BALASAHEB	MECHANICAL ENGINEERING
1145	BEB42	SHINDE RAVIRAJ ADHIKRAO	MECHANICAL ENGINEERING
1146	BEB43	SHINDE TUSHAR NITIN	MECHANICAL ENGINEERING
1147	BEB44	SINGH KANWAR PREET	MECHANICAL ENGINEERING
1148	BEB45	TELWANE AKSHAY RAMKRISHN	MECHANICAL ENGINEERING
1149	BEB46	THAKUR DARSHAN TUKARAM	MECHANICAL ENGINEERING
1150	BEB47	THAKUR DIPESH DIGAMBAR	MECHANICAL ENGINEERING
1151	BEB48	THALE BHUSHAN ASHOK	MECHANICAL ENGINEERING
1152	BEB49	VIGNESH GANESAN RAJARAJESWARI	MECHANICAL ENGINEERING
1153	BEB50	YADAV SHAILESH YUGALKISHOR	MECHANICAL ENGINEERING
1154	BEB51	YADAV UTTAM GOVIND	MECHANICAL ENGINEERING

TRUE COPY



[Handwritten Signature]
 Vishwaniketan's (I MEET)



VISHWANIKETAN

Institute of Management Entrepreneurship and Engineering Technology

Survey No-52 Off Mumbai-Pune Expressway Kumbhivali,

Tal- Khalapur, Maharashtra 410203.

Phone: (02192) 274206/274207/274208/274210

2017-2018

Sr. No.	Roll No.	Name of Student	Name of Program
1	SEA01	AMBADE VISHAJAKHA VINOD	CIVIL ENGINEERING
2	SEA02	AWALE SUPRIYA SITARAM	CIVIL ENGINEERING
3	SEA03	BENDRE BHAGYASHREE RAVINDRA	CIVIL ENGINEERING
4	SEA04	BHASE PRANAL RAMBHAJI	CIVIL ENGINEERING
5	SEA05	BHILARE SURAJ PRAKASH	CIVIL ENGINEERING
6	SEA06	BHOPI ROHAN RAGHUNATH	CIVIL ENGINEERING
7	SEA07	CHAVAN SANKET SURESH	CIVIL ENGINEERING
8	SEA08	CHAVAN VIKAS NAMDEV PURLABAI	CIVIL ENGINEERING
9	SEA09	CHIMANE SANKET SANTOSH	CIVIL ENGINEERING
10	SEA10	CHITTE GAURAV VIKAS	CIVIL ENGINEERING
11	SEA11	DANDEKAR MILAN LALIT	CIVIL ENGINEERING
12	SEA12	DEOKAR YOGESH PITAMBAR	CIVIL ENGINEERING
13	SEA13	DESAI MANGESH PANDURANG	CIVIL ENGINEERING
14	SEA14	DESHMUKH MAYURI SANJAY CHITRA	CIVIL ENGINEERING
15	SEA15	GADGE AKASH BABAJI SUGANDHA	CIVIL ENGINEERING
16	SEA16	GAIKWAD HARSHADA POPAT	CIVIL ENGINEERING
17	SEA17	GAVHANE RUSHIKESH NAMDEO	CIVIL ENGINEERING
18	SEA18	GAWADE ROHIT DEVAPPA	CIVIL ENGINEERING
19	SEA19	GAWAND NINAD RAVINDRA	CIVIL ENGINEERING
20	SEA20	GAWANDE SANJANA SHAILESH	CIVIL ENGINEERING
21	SEA21	GHANATE HARSHAL BABURAO	CIVIL ENGINEERING
22	SEA22	GHARAT PRADNYA YASHAVANT	CIVIL ENGINEERING
23	SEA23	GODE ABHISHEK JAYDEEP	CIVIL ENGINEERING
24	SEA24	GURAV ADITYA ADESH	CIVIL ENGINEERING
25	SEA25	JADHAV AKASH ARUN	CIVIL ENGINEERING
26	SEA26	JADHAV ANIKET SATISH	CIVIL ENGINEERING
27	SEA27	JADHAV SAMEER RAJENDRA	CIVIL ENGINEERING
28	SEA28	JADHAV SWARAJ JAYANT	CIVIL ENGINEERING
29	SEA29	JOSHI UDAY MAHESH	CIVIL ENGINEERING
30	SEA30	KADAM NIKHIL RAMA	CIVIL ENGINEERING
31	SEA31	KALE PRADEEP RAMCHANDRA	CIVIL ENGINEERING
32	SEA32	KANTHALE SHUBHAM D. DANATH	CIVIL ENGINEERING
33	SEA33	KARNUK VRUSHALI RAMBHAJI	CIVIL ENGINEERING
34	SEA34	KAVALE SAURABH SURESH	CIVIL ENGINEERING
35	SEA35	KHAN SAJID AFZAL	CIVIL ENGINEERING
36	SEA36	KHEDEKAR SANKALP SHARAD	CIVIL ENGINEERING
37	SEA37	KOKARE VISHAL BALU	CIVIL ENGINEERING
38	SEA38	KOLI ROHAN JAGAN	CIVIL ENGINEERING

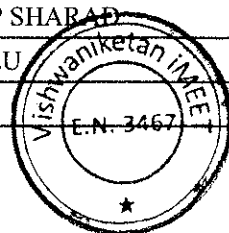

TRUE COPY

Principal
Vishwaniketan's (I MEET)

39	SEA39	KOTHEKAR JANHAVI DATTATRAY	CIVIL ENGINEEING
40	SEA40	KULKARNI KAUSTUBH SACHIN	CIVIL ENGINEEING
41	SEA41	KULKARNI PARAG ANANT	CIVIL ENGINEEING
42	SEA42	KULKARNI SAMEER MAHESH	CIVIL ENGINEEING
43	SEA43	KURANGALE KIRAN KRUSHNA	CIVIL ENGINEEING
44	SEA44	MADANE NANDINI DILIP SUMAN	CIVIL ENGINEEING
45	SEA45	MADHAVI CHAITANYA KISHOR	CIVIL ENGINEEING
46	SEA46	MADHAVI TANMAY DNYANESHWAR	CIVIL ENGINEEING
47	SEA47	MADKE DARSHAN BHARAT	CIVIL ENGINEEING
48	SEA48	MADKE MRUNAL MALHARI	CIVIL ENGINEEING
49	SEA49	MAHABALE SATYAVAN VISHWANATH	CIVIL ENGINEEING
50	SEA50	MAHADIK CHAITANYA CHANDRAKANT LAX	CIVIL ENGINEEING
51	SEA51	MALI SAGAR SANTOSH ARCHANA	CIVIL ENGINEEING
52	SEA52	MHATRE BHUSHAN VISHWNATH	CIVIL ENGINEEING
53	SEA53	MHATRE DIKSHITA BALIRAM	CIVIL ENGINEEING
54	SEA54	MHATRE NISHANT CHANDRASHEKHAR ANIL	CIVIL ENGINEEING
55	SEA55	MHATRE PRATIK BHANUDAS	CIVIL ENGINEEING
56	SEA56	MHATRE SIDDHANT SANJAY	CIVIL ENGINEEING
57	SEA57	MHATRE VIPUL SHRIPAT	CIVIL ENGINEEING
58	SEA58	MOHITE MANSEE MOHAN	CIVIL ENGINEEING
59	SEA59	MOKAL HARSHADA VISHAVNATH	CIVIL ENGINEEING
60	SEA60	MOKAL PRAJWAL SUNIL	CIVIL ENGINEEING
61	SEA61	MOKAL SHUBHAM SANTOSH	CIVIL ENGINEEING
62	SEA62	MUJAWAR SALMAN TASLIM WAHIDA	CIVIL ENGINEEING
63	SEA63	MUKKU PRASHANTHAKUMAR VENKA	CIVIL ENGINEEING
64	SEA64	NAGDIVE NIVESH SUDHIR MRUDULA	CIVIL ENGINEEING
65	SEA65	NAIK JAYESH CHANDRAKANT	CIVIL ENGINEEING
66	SEA66	NARANGIKAR HARSHADA ANIL	CIVIL ENGINEEING
67	SEA67	NAVALE SANJEEVANI SURYAKANT	CIVIL ENGINEEING
68	SEB01	OJHA SANJEEVKUMAR TRILOCHAN MEENA	CIVIL ENGINEEING
69	SEB02	OSWAL DUSHANT MANISH SANGITA	CIVIL ENGINEEING
70	SEB03	PADWANKAR SAURABH SANJAY ASHWINI	CIVIL ENGINEEING
71	SEB04	PANDHARE RUSHIKESH DNYANDEV	CIVIL ENGINEEING
72	SEB05	PATIL AARTI PRALHAD	CIVIL ENGINEEING
73	SEB06	PATIL KEDAR SHARAD REKHA	CIVIL ENGINEEING
74	SEB07	PATIL OMKAR KISHOR	CIVIL ENGINEEING
75	SEB08	PATIL OMKAR MADHUKAR	CIVIL ENGINEEING
76	SEB09	PATIL PRATIKSHA YASHWANT	CIVIL ENGINEEING
77	SEB10	PATIL RATNESH RAMAKANT	CIVIL ENGINEEING
78	SEB11	PATIL SAYALI ANIL	CIVIL ENGINEEING
79	SEB12	PATIL SAYLI KISHOR KALAYATI	CIVIL ENGINEEING
80	SEB13	PATIL SHUBHAM MOHAN	CIVIL ENGINEEING
81	SEB14	PATIL TEJAL VASUDEV	CIVIL ENGINEEING
82	SEB15	PATIL TEJASWINI VIKAS	CIVIL ENGINEEING

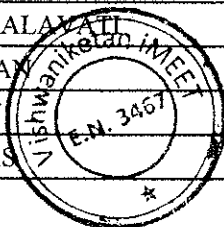

TRUE COPY

[Signature]
Principal
Vishwaniketan's (I MEET)

83	SEB16	PATIL UMANG DHANAJI	CIVIL ENGINEERING
84	SEB17	PETHE ANKIT RAJENDRA	CIVIL ENGINEERING
85	SEB18	PINGALE ROHINI SANTOSH	CIVIL ENGINEERING
86	SEB19	POKHARKAR NILESH RAMDAS	CIVIL ENGINEERING
87	SEB20	RANGARI VIPUL DEVANAND	CIVIL ENGINEERING
88	SEB21	SAITAWADEKAR SAURABH RAMESH	CIVIL ENGINEERING
89	SEB22	SALVI PRASENJIT RAJESH	CIVIL ENGINEERING
90	SEB23	SANAP ABHISHEK SHAILESH	CIVIL ENGINEERING
91	SEB24	SAPKAL PIYUSH RAJESH	CIVIL ENGINEERING
92	SEB25	SATVE AKSHAY ANANTA	CIVIL ENGINEERING
93	SEB26	SAVALE BHUPESH HIMMATRAO	CIVIL ENGINEERING
94	SEB27	SAWANT CHIRAG DEEPAK NIRMALA	CIVIL ENGINEERING
95	SEB28	SAWANT PRATIK JAGADISH	CIVIL ENGINEERING
96	SEB29	SHAH VISHESH SANDEEP	CIVIL ENGINEERING
97	SEB30	SHINDE ANKITA PRASHANT SAYALI	CIVIL ENGINEERING
98	SEB31	SHINDE VISHAL PRAKASH	CIVIL ENGINEERING
99	SEB32	SHIRKE ASHITOSH SURESH	CIVIL ENGINEERING
100	SEB33	SINGH SANJU ARUNKUMAR	CIVIL ENGINEERING
101	SEB34	SURYAWANSHI SIDDHANT BANDOPANT	CIVIL ENGINEERING
102	SEB35	THAKUR ABHISHEK ANIL	CIVIL ENGINEERING
103	SEB36	THAKUR OMKAR ANAND NILAM	CIVIL ENGINEERING
104	SEB37	THAKUR SARVESH CHANDRASHEKHAR GIT	CIVIL ENGINEERING
105	SEB38	THAKUR SHILPA NARAYAN	CIVIL ENGINEERING
106	SEB39	THAKUR VAIBHAV PURUSHOTTAM	CIVIL ENGINEERING
107	SEB40	THUBE PRATIKSHA GITARAM	CIVIL ENGINEERING
108	SEB41	UGHADA VILAS DURGADAS	CIVIL ENGINEERING
109	SEB42	WAGH PANKAJ BALU	CIVIL ENGINEERING
110	SEB43	WAGHMARE BHAGYASHRI MOHAN	CIVIL ENGINEERING
111	SEB44	THORAT ROHIT KISHOR	CIVIL ENGINEERING
112	SEB45	WAKADE SNEHAL PRADEEP	CIVIL ENGINEERING
113	SEB46	BATHIJA KUNAL R	CIVIL ENGINEERING
114	SEB47	BORKAR ADITYA PRADEEP	CIVIL ENGINEERING
115	SEB48	DANDEKAR NIKHIL JAYENDRA	CIVIL ENGINEERING
116	SEB49	FERNANDES ALVES	CIVIL ENGINEERING
117	SEB50	KAMBLE ANKUR RAJEH	CIVIL ENGINEERING
118	SEB51	KUMAVAT KIRAN DAGA	CIVIL ENGINEERING
119	SEB52	KUNDALE SWAPNIL	CIVIL ENGINEERING
120	SEB53	MAHALE KIRAN HARISH	CIVIL ENGINEERING
121	SEB54	MHATRE CHIRAYU JAHINDRANATH	CIVIL ENGINEERING
122	SEB55	MHATRE NISHANT MANOHAR	CIVIL ENGINEERING
123	SEB56	MOTE TEJAS CHANDRAKANT	CIVIL ENGINEERING
124	SEB57	MULEY PRANAY TEJRAO	CIVIL ENGINEERING
125	SEB58	PATIL JAYESH MOHAN	CIVIL ENGINEERING
126	SEB59	PATIL RAHUL SURESH	CIVIL ENGINEERING

TRUE COPY

[Signature]
Principal
Vishwanath's (I MEET)

127	SEB60	PAWAR ASHUTOSH SHIVA		CIVIL ENGINEERING
128	SEB61	PUNYARTHI RUSHIKESH S.	NAND	CIVIL ENGINEERING
129	SEB62	SALVI DARSHAN MANOHA		CIVIL ENGINEERING
130	SEB63	SHARMA VIKASH MANOJ		CIVIL ENGINEERING
131	SEB64	SHETYE RIDDHI ASHISH M		CIVIL ENGINEERING
132	SEB65	SHINDE NIKHIL RAMESH		CIVIL ENGINEERING
133	SEB66	WANALEKAR VARSHA HA	HANTRAO	CIVIL ENGINEERING
134	SEB67	YADAV NIRANJAN VITTHL		CIVIL ENGINEERING
135	TEA01	AHINAVE NIKHIL JALINDA		CIVIL ENGINEERING
136	TEA02	AMIRKHAN ABDUL RASID		CIVIL ENGINEERING
137	TEA03	AUTADE KUNAL BHAUSA	VIDYA	CIVIL ENGINEERING
138	TEA04	AWARGAND VISHAL LAXE	VAISHALI	CIVIL ENGINEERING
139	TEA05	BADE ROSHAN JAGDISH M	RA	CIVIL ENGINEERING
140	TEA06	BARASKAR DEVAYANI DN	NESHWAR	CIVIL ENGINEERING
141	TEA07	BHAGAT ACHAL VIJAY SA	A	CIVIL ENGINEERING
142	TEA08	BHALEKAR AKSHAY SUBI	H	CIVIL ENGINEERING
143	TEA09	BHANGALE HEMANT PRA	D	CIVIL ENGINEERING
144	TEA10	BHOIR VIJAY JAGANNATH		CIVIL ENGINEERING
145	TEA11	BHOIR SHUBHAM HEMAN		CIVIL ENGINEERING
146	TEA12	BHOITE VARSHA NATHA	AN	CIVIL ENGINEERING
147	TEA13	BIRADAR AMAR SHRKAN	DYA	CIVIL ENGINEERING
148	TEA14	CHAUDHARI BHARAT SU	KIRTI	CIVIL ENGINEERING
149	TEA15	CHAVAN SHIVRAJ CHANE	KANT	CIVIL ENGINEERING
150	TEA16	CHAVAN UJJWAL PRAKAS	ARANGIDEVI	CIVIL ENGINEERING
151	TEA17	CHAVAN GOVIND SHUBH	MUNNI	CIVIL ENGINEERING
152	TEA18	CHAWAN RAKESH ROHID		CIVIL ENGINEERING
153	TEA19	CHEPATE RUSHIKESH GA	NATH	CIVIL ENGINEERING
154	TEA20	CHOWDHARI CHINMAY P	MOD	CIVIL ENGINEERING
155	TEA21	DESHMANE SAHITYA RA	LAL RAJANI	CIVIL ENGINEERING
156	TEA22	DESHMUKH SURAJ CHAN	KANT	CIVIL ENGINEERING
157	TEA23	DESHMUKH SANKET BAP	O SARIKA	CIVIL ENGINEERING
158	TEA24	DHENDE MAYUR		CIVIL ENGINEERING
159	TEA25	DHAMANE SANDESH SHE	R UJWALA	CIVIL ENGINEERING
160	TEA26	DHOBLE OMKAR RAMCH.	RA	CIVIL ENGINEERING
161	TEA27	DHONGADE SANDHYA DI	ANJAY	CIVIL ENGINEERING
162	TEA28	DUDUSKAR ROHAN SURE	SUCHITA	CIVIL ENGINEERING
163	TEA29	GAIKWAD SWAPNIL SUR	ANT	CIVIL ENGINEERING
164	TEA30	GAIKWAD SIDDHESH BHA	T	CIVIL ENGINEERING
165	TEA31	GAIKWAD HARSHADA PC		CIVIL ENGINEERING
166	TEA32	GAMARE SAGAR SUBHAS		CIVIL ENGINEERING
167	TEA33	GANDAGE SHANKAR SHR	IANT	CIVIL ENGINEERING
168	TEA34	GHANGHAV HARSHVARI	MUKUND	CIVIL ENGINEERING
169	TEA35	GHARAT KUNAL JAYDE		CIVIL ENGINEERING
170	TEA36	SHARAT VIKRAM SUBHA		CIVIL ENGINEERING



TRUE COPY

Principal
Vishwaniketan's (I) MEET

171	TEA37	HA	UJITESH VILAS	CIVIL ENGINEEING
172	TEA38	HE	SNEHAL	CIVIL ENGINEEING
173	TEA39	ING	VIJAY DASHRATH	CIVIL ENGINEEING
174	TEA40	JAI	V AKSHAY ASHOK MEENAKSHI	CIVIL ENGINEEING
175	TEA41	JAI	V AKSHAY BABURAO TRUPTI	CIVIL ENGINEEING
176	TEA42	JAI	V JIVAN KRISHNA JAYSHREE	CIVIL ENGINEEING
177	TEA43	JAI	V NISHANT SHANTARAM JAYSHREE	CIVIL ENGINEEING
178	TEA44	JAI	V VISHAL PARSHURAM	CIVIL ENGINEEING
179	TEA45	JAI	LE AMIT LAHURAJ	CIVIL ENGINEEING
180	TEA46	JAI	AL VIJAYLAXMI RAMANAND ASHA	CIVIL ENGINEEING
181	TEA47	JH	EPAK SUSHILKUMAR	CIVIL ENGINEEING
182	TEA48	JO	ALE SOHAM SHAILENDRA	CIVIL ENGINEEING
183	TEA49	KA	LE ANJALI RAJESH (P)	CIVIL ENGINEEING
184	TEA50	KA	LE KRUTIKA VIJAY	CIVIL ENGINEEING
185	TEA51	KA	LE SHWETA S. (P)	CIVIL ENGINEEING
186	TEA52	KA	LE TANMAY DAYANAND	CIVIL ENGINEEING
187	TEA53	KA	NDE MAHESH NANDKUMAR SNEHA	CIVIL ENGINEEING
188	TEA54	KA	D PRADIP SHIVAJI MEENA	CIVIL ENGINEEING
189	TEA55	KI	SAMBALE SONIYA HEMNATH MINAXI	CIVIL ENGINEEING
190	TEA56	KI	PRATHAMESH SUNIL RAJASHREE	CIVIL ENGINEEING
191	TEA57	KO	ATYAJEET HARIDAS	CIVIL ENGINEEING
192	TEA58	KU	NKAR ANKITA SHREEDHAR	CIVIL ENGINEEING
193	TEA59	KI	LE PRATIKSHA JAGANNATH	CIVIL ENGINEEING
194	TEA60	LC	NDE VIKAM PRAKASH NANDA	CIVIL ENGINEEING
195	TEA61	M.	SARE AKASH ASHOK	CIVIL ENGINEEING
196	TEA62	M	VISHNU RAMCHANDRA GANGA	CIVIL ENGINEEING
197	TEA63	M	R PRADNESH PRAFULL	CIVIL ENGINEEING
198	TEA64	M	SAGAR	CIVIL ENGINEEING
199	TEA65	M	SUMIT	CIVIL ENGINEEING
200	TEA66	M	NE KAPIL MANGAL	CIVIL ENGINEEING
201	TEA67	M	E PRACHI SUNIL	CIVIL ENGINEEING
202	TEB01	M	RNUR SURAJ KUMAR	CIVIL ENGINEEING
203	TEB02	M	RE SAMIR SANJAY	CIVIL ENGINEEING
204	TEB03	M	RE TEJASVI RAVINDRA	CIVIL ENGINEEING
205	TEB04	M	RE AMITA RAMESH	CIVIL ENGINEEING
206	TEB05	M	RE CHHAYA SUBHASH SHUBHANGI	CIVIL ENGINEEING
207	TEB06	M	RE HARSHALI JANARDAN	CIVIL ENGINEEING
208	TEB07	M	RE KARAN GIRIDHAR	CIVIL ENGINEEING
209	TEB08	M	RE NIKHIL KAILASH	CIVIL ENGINEEING
210	TEB09	M	RE PRAJAKTA PRABHAKAR DARSHAN	CIVIL ENGINEEING
211	TEB10	M	L VAIBHAVI SUNIL	CIVIL ENGINEEING
212	TEB11	M	TE SHUBHAM ASHOK	CIVIL ENGINEEING
213	TEB12	M	VISHAKHA RAMCHANDRAJUVALA	CIVIL ENGINEEING
214	TEB13	M	E PRADIP SHRIRAM	CIVIL ENGINEEING

TRUE COPY



[Signature]
Principal

Vishwanandan's (I) MEE

215	TEB14	AIK VIKRANT VISHNU	CIVIL ENGINEERING
216	TEB15	AMBALKAR VIRAJ VINAYKUMAR	CIVIL ENGINEERING
217	TEB16	ASHAL AKSHITA BHAGWAN	CIVIL ENGINEERING
218	TEB17	ASHKHAR YOGESH RAMESH RAMILA	CIVIL ENGINEERING
219	TEB18	ATIL AKASH CHANDRAKANT	CIVIL ENGINEERING
220	TEB19	ATIL ANIKET ARUN NANDA	CIVIL ENGINEERING
221	TEB20	ATIL NAMRATA	CIVIL ENGINEERING
222	TEB21	ATIL DIPIL VIJAY	CIVIL ENGINEERING
223	TEB22	ATIL GIRISH PANDIT	CIVIL ENGINEERING
224	TEB23	ATIL HARSHADA GAJENDRA SANGITA	CIVIL ENGINEERING
225	TEB24	ATIL MANALI MADHUKAR	CIVIL ENGINEERING
226	TEB25	ATIL NIVRUTTI ANKUSH	CIVIL ENGINEERING
227	TEB26	ATIL PAYAL EKNATH	CIVIL ENGINEERING
228	TEB27	ATIL PRACHIT PRAMOD	CIVIL ENGINEERING
229	TEB28	ATIL PRANAV PRABHAKAR	CIVIL ENGINEERING
230	TEB29	ATIL PRANIT ANIL ANITA	CIVIL ENGINEERING
231	TEB30	ATIL RAHUL TUKARAM	CIVIL ENGINEERING
232	TEB31	ATIL RUPALI VASUDEV	CIVIL ENGINEERING
233	TEB32	ATIL SAGAR SANDEEP SMITA	CIVIL ENGINEERING
234	TEB33	ATIL HARSHAD RAMDAS SUREKHA	CIVIL ENGINEERING
235	TEB34	ATIL PRATIK NARAYAN	CIVIL ENGINEERING
236	TEB35	ATIL VARSHA DHANANJAY	CIVIL ENGINEERING
237	TEB36	PAWAR KALYANI DIGAMBAR	CIVIL ENGINEERING
238	TEB37	POPHALE VIJAY RAJARAM DIPIKA	CIVIL ENGINEERING
239	TEB38	RAJGURU MAYURI	CIVIL ENGINEERING
240	TEB39	RAUT YOGESH RAJENDRA	CIVIL ENGINEERING
241	TEB40	REDDY SONIA RAKESH	CIVIL ENGINEERING
242	TEB41	RUPANVAR AKASH DATTU	CIVIL ENGINEERING
243	TEB42	SALUNKHE SWAPNIL	CIVIL ENGINEERING
244	TEB43	SANGE SUSHANT SANTOSH SANGEETA	CIVIL ENGINEERING
245	TEB44	SAWANT CHIRAG D	CIVIL ENGINEERING
246	TEB45	SHAHASANE DURVESH UDAYKUMAR	CIVIL ENGINEERING
247	TEB46	SHETE NIKHIL NAVIN	CIVIL ENGINEERING
248	TEB47	SHENDGE MEGHA LAXMAN SHALAN	CIVIL ENGINEERING
249	TEB48	SHINDE SHUBHAM JAGANNATH	CIVIL ENGINEERING
250	TEB49	SHINDE SHUBHAM SUDHIR	CIVIL ENGINEERING
251	TEB50	SHINDE ANKITA	CIVIL ENGINEERING
252	TEB51	SHIRKE KRUTIKA KISAN	CIVIL ENGINEERING
253	TEB52	SOLKAR ROHIT RAJENDRA	CIVIL ENGINEERING
254	TEB53	SONAWANE SHUBHAM HIRALAL	CIVIL ENGINEERING
255	TEB54	SURVASE PRATIK DHANRAJ ANITA	CIVIL ENGINEERING
256	TEB55	SURYAWANASHI MAYUR DINKAR PREMA	CIVIL ENGINEERING
257	TEB56	TAMAKHE MANGESH BIRA KAMAL	CIVIL ENGINEERING
258	TEB57	TAMGADGE ANIKET ANIL	CIVIL ENGINEERING



TRUE COPY

B.K.P.

Principal

Vishwaniketan's (I MEET)

259	TEB58	THAKUR VRUSHAL RAJESH	CIVIL	ENGINEERING
260	TEB59	TUPE ANIKET ANANTA	CIVIL	ENGINEERING
261	TEB60	VAGHANI PARTH DEVSHI	CIVIL	ENGINEERING
262	TEB61	WAGHMARE ABHIJIT SUNIL	CIVIL	ENGINEERING
263	TEB62	WASKAR PRATHAMESH KISHOR	CIVIL	ENGINEERING
264	TEB63	YADAV RAJ DEEPAK (P)	CIVIL	ENGINEERING
265	TEB64	YADAV SAURABH PRAVIN	CIVIL	ENGINEERING
266	TEB65	ZIMBAL GIRISH VISHNU SANGEETA	CIVIL	ENGINEERING
267	TEB66	BADE ASHWINI AJINATH	CIVIL	ENGINEERING
268	TEB67	RANE VISHWADH PRASHANT	CIVIL	ENGINEERING
269	BEA01	BAVISKAR AMIT YUVARAJ JYOTI	CIVIL	ENGINEERING
270	BEA02	BHAGWAT PRATHAMESH ASHOK SUNITA	CIVIL	ENGINEERING
271	BEA03	BHARATI TUSHAR SANJAY MANDA	CIVIL	ENGINEERING
272	BEA04	BHOIR APEKSHA ARVIND SANDHYA	CIVIL	ENGINEERING
273	BEA05	BHOIR HARSHAD HEMANT SHASHIKALA	CIVIL	ENGINEERING
274	BEA06	CHAVAN TEJASHREE DADASAHEB SUNAND	CIVIL	ENGINEERING
275	BEA07	CHAVARKAR NIKHIL KASHINATH KAVITA	CIVIL	ENGINEERING
276	BEA08	DAUR PRATIK TULASHIDAS KUNDA	CIVIL	ENGINEERING
277	BEA09	DAWANI MAYUR ASHOK MAMTA	CIVIL	ENGINEERING
278	BEA10	DHAVAN AJINKYA NARENDRA NALINI	CIVIL	ENGINEERING
279	BEA11	DUKARE GAURAV RAMESH LATA	CIVIL	ENGINEERING
280	BEA12	GAUD MANGESH SHYAMNARAYAN RADHIK	CIVIL	ENGINEERING
281	BEA13	GAVAND DHANANJAY DAMODAR MINAKSHI	CIVIL	ENGINEERING
282	BEA14	GAWAND PRANALI DINANATH BHAMINI	CIVIL	ENGINEERING
283	BEA15	GHANGALE PRATIK ASHOK NEELAM	CIVIL	ENGINEERING
284	BEA16	GURAV RAKSHANDA SURENDRA SNEHAL	CIVIL	ENGINEERING
285	BEA17	HATE MANISH MUKESH MANISHA	CIVIL	ENGINEERING
286	BEA18	HATNOLKAR KANCHAN RAJENDRA JAYASH	CIVIL	ENGINEERING
287	BEA19	INGULKAR AKASH PRAKASH NANDA	CIVIL	ENGINEERING
288	BEA20	JAMDHADE SHUBHAM DIGAMBAR NANDA	CIVIL	ENGINEERING
289	BEA21	JAMBHALE PRAKASH DIPAK SEETA	CIVIL	ENGINEERING
290	BEA22	JERATH SHIKHAR MANISH BINTI	CIVIL	ENGINEERING
291	BEA23	JOSHI ABHISHEK RAJEEV ARUNA	CIVIL	ENGINEERING
292	BEA24	KADU VINAY GANESH RAJASHREE	CIVIL	ENGINEERING
293	BEA25	KANSAGARA PARTH SANJAY KUMAR RITA	CIVIL	ENGINEERING
294	BEA26	KARJIKAR YASIN RAZZAK MUNNWAR	CIVIL	ENGINEERING
295	BEA27	KARWAL RAHUL BHAUSAHEB MALTI	CIVIL	ENGINEERING
296	BEA28	KATKE GAJANAN MAHADEV CHANCHAL	CIVIL	ENGINEERING
297	BEA29	KAWALE POOJA BABU SARU	CIVIL	ENGINEERING
298	BEA30	KHANDAGALE HRUSHIKESH RAJENDRA BH	CIVIL	ENGINEERING
299	BEA31	KHANOLKAR ADITYA UDAY NALINI	CIVIL	ENGINEERING
300	BEA32	KOLI VINESH SHIVDAS KAMALA	CIVIL	ENGINEERING
301	BEA33	KSHIRSAGAR VAIBHAV RAMCHANDRA HIR	CIVIL	ENGINEERING
302	BEA34	KUDALE POONAM JAGANNATH LAXMI	CIVIL	ENGINEERING



TRUE COPY

[Handwritten Signature]

Principal

Vishwaniketan's (I.M.E.T.)

303	BEA35	MANAJI TEJASWINI RAJARAM SANGEETA	CIVIL ENGINEEING
304	BEA36	MANYAR JUBER TAYYAB ALI BISMILLAH	CIVIL ENGINEEING
305	BEA37	MHASKAR SAMEER GOVIND GEETA	CIVIL ENGINEEING
306	BEA38	MHATRE ADITYA SAMADHAN VAJANTI	CIVIL ENGINEEING
307	BEA39	MHATRE PRANAV KAMALAKAR PRABHAVA	CIVIL ENGINEEING
308	BEA40	MHATRE PRANITA MUKUND GEETA	CIVIL ENGINEEING
309	BEA41	MHATRE SAGAR VASUDEV DARSHANA	CIVIL ENGINEEING
310	BEA42	MHATRE SHUBHAM KISHOR SHUBHANGI	CIVIL ENGINEEING
311	BEA43	NAIK KRUPA SANTOSH ASHWINI	CIVIL ENGINEEING
312	BEA44	NAIK YASIN HABIBULLA NURJAHA	CIVIL ENGINEEING
313	BEA45	NALAWADE AJINKYA RAMESH SANGEETA	CIVIL ENGINEEING
314	BEA46	NAVALE SHUBHAM DATTATRAY UJWALA	CIVIL ENGINEEING
315	BEA47	OULKAR SHUBHAM HEMANT UJWALA	CIVIL ENGINEEING
316	BEA48	PANDIT SIKANDAR PURAN GITADEVI	CIVIL ENGINEEING
317	BEA49	PARKAR PARAG KHANDOJI SUGANDHA	CIVIL ENGINEEING
318	BEA50	PATIL ABHIJIT NARENDRA NANDA	CIVIL ENGINEEING
319	BEB01	PATIL ABHIJIT ASHOK PRIYA	CIVIL ENGINEEING
320	BEB02	PATIL AKSHAY NAMDEV NIVEDITA	CIVIL ENGINEEING
321	BEB03	PATIL ANIKET ASHOK ANEETA	CIVIL ENGINEEING
322	BEB04	PATIL KOMAL DILIP SEEMA	CIVIL ENGINEEING
323	BEB05	PATIL PRATHAMESH MACHHINDRA SUNITA	CIVIL ENGINEEING
324	BEB06	PATIL PRIYANKA RAGHUNATH PRABHAVA	CIVIL ENGINEEING
325	BEB07	PATIL RHUSHIKESH RAMESH REEMA	CIVIL ENGINEEING
326	BEB08	PATIL SUPRIYA PRAKASH SULOCHANA	CIVIL ENGINEEING
327	BEB09	PATIL VAISHNAVI PANDHARINATH PUSHPA	CIVIL ENGINEEING
328	BEB10	PAWAR SNEHAL ARUN JAYSHREE	CIVIL ENGINEEING
329	BEB11	POKALE SUHAS HANUMANT SWAPNALI	CIVIL ENGINEEING
330	BEB12	POPHALE SHUBHAM SURYAKANT SHEETAL	CIVIL ENGINEEING
331	BEB13	RANE VASUDEV JAYWANT SHOBHA	CIVIL ENGINEEING
332	BEB14	RATHOD VIJAY GOVIND KAMLABAI	CIVIL ENGINEEING
333	BEB15	RAUT SANCHITA SANTOSH SUNITA	CIVIL ENGINEEING
334	BEB16	SANAS OMKAR VITHAL SANDHYA	CIVIL ENGINEEING
335	BEB17	SAWANT PRATIK CHANDRAKANT MANISHA	CIVIL ENGINEEING
336	BEB18	SENJALIYA DEEPESH RAMESH JAYSHREE	CIVIL ENGINEEING
337	BEB19	SHAHASANE HARSHAL ANAND VARSHA	CIVIL ENGINEEING
338	BEB20	SHAHASANE NISHAD PRADEEP PRATIBHA	CIVIL ENGINEEING
339	BEB21	SHEDAVAL SHUBHAM SANJAY MANJULA	CIVIL ENGINEEING
340	RFB22	SHELKE SAGAR GOVIND SAVITA	CIVIL ENGINEEING
341	BEB23	SHETE SUMIT SOMNATH SULAKSHANA	CIVIL ENGINEEING
342	BEB24	SHINDE SHUBHAM RAMDAS JAYSHREE	CIVIL ENGINEEING
343	BEB25	SHINDE SOMNATH SURYAKANT LATA	CIVIL ENGINEEING
344	BEB26	SINGH SUSHIL NARENDRA ASHOKA	CIVIL ENGINEEING
345	BEB27	SINGH SHAKTI PHOOL DARIYA	CIVIL ENGINEEING
346	BEB28	SONAR MEGHNA VIJAYKUMAR SANGITA	CIVIL ENGINEEING



TRUE COPY

[Handwritten Signature]

Principal
Vishwaniketan's (IMET)

347	B29	SWAMI TEJAS JAGAN SARLA	CIVIL ENGINEERING
348	B30	TALESA PRAVINKUMAR MANGILAL HANJAI	CIVIL ENGINEERING
349	B31	TAMBE PRATIK KHANDU MEENAKSHI	CIVIL ENGINEERING
350	B32	TANPURE AKASH DILIP REKHA	CIVIL ENGINEERING
351	B33	WAGH TANMAY PANDURANG RAJSHREE	CIVIL ENGINEERING
352	B34	JADHAV AKASH BAPUSAHEB	CIVIL ENGINEERING
353	B35	JAISWAR DAISY	CIVIL ENGINEERING
354	B36	MHATRE SUJATA SALUNKHE PRATIK	CIVIL ENGINEERING
355	B37	SALUNKHE PRATIK	CIVIL ENGINEERING
356	B38	SATYAM VINAY	CIVIL ENGINEERING
357	B39	THPMBARE SURAJ	CIVIL ENGINEERING
358	B40	BHALERAO ROSHAN	CIVIL ENGINEERING
359	B41	MASANE RAJENDRA KALURAM	CIVIL ENGINEERING
360	B42	MHATRE VISHAL	CIVIL ENGINEERING
361	B43	MUNDE KAILASH	CIVIL ENGINEERING
362	B44	NIKAM ONKAR SHRIKANT	CIVIL ENGINEERING
363	B45	PALKAR MAYURESH	CIVIL ENGINEERING
364	B46	PANDIT VIKRANT	CIVIL ENGINEERING
365	B47	REDDY UMAKANT	CIVIL ENGINEERING
366	B48	SAIFI MOHD JUNED JABIR	CIVIL ENGINEERING
367	B49	VAIDYA PRATIK PRADEEP	CIVIL ENGINEERING
368	B50	KALYADAPU VISHAL	CIVIL ENGINEERING
369	B51	JADHAV GAURAV MAHENDRA	CIVIL ENGINEERING
370	B52	SATHEKAR BHAKTI GURUNATH	CIVIL ENGINEERING
371	B53	DESHMUKH KUNAL	CIVIL ENGINEERING
372	SCS01	ANANDRAO SACHIN BHIMRAO RANJANA	COMPUTER ENGINEERING
373	SCS02	ANCHALKAR TANMAY UMESH ARCHANA	COMPUTER ENGINEERING
374	SCS03	ATTAR NAMRA IQBAL REHANA	COMPUTER ENGINEERING
375	SCS04	BADEKAR SAYALI BAJIRAO MANISHA	COMPUTER ENGINEERING
376	SCS05	CHAVAN OMKAR TANAJI CHHAYA	COMPUTER ENGINEERING
377	SCS06	CHIKHALEKAR SNEHANKIT JANARDAN JAG	COMPUTER ENGINEERING
378	SCS07	CHOURASIYA PAWANKUMAR SHRAVANPRA	COMPUTER ENGINEERING
379	SCS08	DALAL PRATHAMESH MANGESH MANALI	COMPUTER ENGINEERING
380	SCS09	DANDEKAR SNEHAL RAJENDRA RASHMI	COMPUTER ENGINEERING
381	SCS10	DESHMUKH SAGAR JAGDISH URMILA	COMPUTER ENGINEERING
382	SCS11	DONGRE KRISHNAM AKSHAY JAYA	COMPUTER ENGINEERING
383	SCS12	GAIKWAD PRANAY PRAKASH SUNITA	COMPUTER ENGINEERING
384	SCS13	GAJBHIYA ANKUL PRAMOD SAVITA	COMPUTER ENGINEERING
385	SCS14	GALAVE SAGAR SHANKAR SHARADA	COMPUTER ENGINEERING
386	SCS15	GAWAS SONALI RAMKRISHNA RAMA	COMPUTER ENGINEERING
387	SCS16	GUPTA PRATIK MAHESH VAISHALI	COMPUTER ENGINEERING
388	SCS17	GUPTA SUJITKUMAR SANTOSH NEETA	COMPUTER ENGINEERING
389	SCS18	GURAV KOMAL RAVINDRA SUVARNA	COMPUTER ENGINEERING
390	SCS20	KAKADE AISHWARYA SATISH SUPRIYA	COMPUTER ENGINEERING

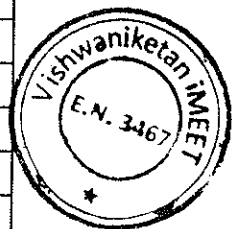

TRUE COPY

Principal
Vishwaniketan's (I INMET)

391	SCS21	KALE	NIKA DEVAJI ASHA	COMPUTE R ENGINEERING
392	SCS22	KANA	ABHISHEK ASHOK VANDANA	COMPUTE R ENGINEERING
393	SCS23	KAWA	SWAGATA NITESH NIKITA	COMPUTE R ENGINEERING
394	SCS24	KHEEL	R AISHWARYA RAJENDRA SMITA	COMPUTE R ENGINEERING
395	SCS25	KOLP	RISHIKESH JITENDRA MANSI	COMPUTE R ENGINEERING
396	SCS26	KULK	NI NARAYAN RAJESHWAR VARSHA	COMPUTE R ENGINEERING
397	SCS27	KUMA	ONAL ARUN NILU	COMPUTE R ENGINEERING
398	SCS28	LAMA	E SIMRAN JAHANGIR MASAYABI	COMPUTE R ENGINEERING
399	SCS29	MANI	EPALI GOPAL JYOTSNA	COMPUTE R ENGINEERING
400	SCS30	MASA	GAURI DATTATREY DAKSHATA	COMPUTE R ENGINEERING
401	SCS32	MHA	VAIBHAV NARESH SHOBHA	COMPUTE R ENGINEERING
402	SCS34	MOKA	JUNVANT VITTHAL ANUSAYA	COMPUTE R ENGINEERING
403	SCS35	MURA	AR ATHARVA MADHUKAR SHUBHA	COMPUTE R ENGINEERING
404	SCS36	PALA	E AVDHUT ATUL ATUSHA	COMPUTE R ENGINEERING
405	SCS37	PARA	E SHUBHAM RAJENDRA KANCHAN	COMPUTE R ENGINEERING
406	SCS38	PATIL	IEY ANKUSH ASHA	COMPUTE R ENGINEERING
407	SCS39	PATIL	GRUTI ANIL JAYMALA	COMPUTE R ENGINEERING
408	SCS40	PATIL	OTI RAMESH REEMA	COMPUTE R ENGINEERING
409	SCS41	PATIL	INAL VIJAY SANDHYA	COMPUTE R ENGINEERING
410	SCS42	PATIL	MKAR SURYAKANT SAVITA	COMPUTE R ENGINEERING
411	SCS43	PATIL	ITUJA ANKUSH REKHA	COMPUTE R ENGINEERING
412	SCS44	PATIL	DDHESH SAMBHAJI VATSALA	COMPUTE R ENGINEERING
413	SCS45	PATIL	VAPNIL RAMCHANDRA SHEETAL	COMPUTE R ENGINEERING
414	SCS46	PATIL	JAS BALU BHARATI	COMPUTE R ENGINEERING
415	SCS47	PAWA	RRIYA SANDEEP SARIKA	COMPUTE R ENGINEERING
416	SCS48	PAWA	SAMRUDDHI SANJAY SUNANDA	COMPUTE R ENGINEERING
417	SCS49	PAWA	SAURABH SURENDRA SUVIDHA	COMPUTE R ENGINEERING
418	SCS50	POO	ABHISHEK RAVI JYOTHI	COMPUTE R ENGINEERING
419	SCS51	PUJA	ISHWARYA SHIVAJI KANTI	COMPUTE R ENGINEERING
420	SCS52	RAI	RASAD MANHOR RAJARATHNA	COMPUTE R ENGINEERING
421	SCS53	RAJ	RITENDRAPRATAPSINGH JAHARSIN	COMPUTE R ENGINEERING
422	SCS54	SAN	VI MAYANK ATUL NITA	COMPUTE R ENGINEERING
423	SCS55	SANI	L. ASHISH SHANKAR PARVATI	COMPUTE R ENGINEERING
424	SCS56	SAPA	AKSHAY PRAKASH HEMA	COMPUTE R ENGINEERING
425	SCS57	SARA	DHIRAJ DNYANRAJ DIVYA	COMPUTE R ENGINEERING
426	SCS58	SAWA	SIDDESH ASHOK RUPALI	COMPUTE R ENGINEERING
427	SCS59	SAY	ALFIYA RASHID SABERA	COMPUTE R ENGINEERING
428	SCS60	SHA	DEEPIKA BHAGWAN USHA	COMPUTE R ENGINEERING
429	SCS61	SHEV	E SHUBHAM LAXMAN SANGEETA	COMPUTE R ENGINEERING
430	SCS62	SHIN	VISHAL SATISH MANISHA	COMPUTE R ENGINEERING
431	SCS63	SHIN	RE PRASHANT DEEPAK DARSHANA	COMPUTE R ENGINEERING
432	SCS64	SINC	UPESHKUMAR NARENDRA MEENA	COMPUTE R ENGINEERING
433	SCS65	SUR	ANSHI VINAYAK MANOJ REKHA	COMPUTE R ENGINEERING
434	SCS66	TAN	AATISH PRAKASH SUNITA	COMPUTE R ENGINEERING



TRUE COPY

[Signature]

Principal

Vishwaniketan's (I MEET)

435	SCS67	TARANGE HARSHADA PRATAP KUNDAN	COMPUTE R ENGINEERING
436	SCS68	THAKUR NIKITA JAGDISH URMILA	COMPUTE R ENGINEERING
437	SCS69	THONGE VISHAKHA VIKAS SWATI	COMPUTE R ENGINEERING
438	SCS70	THORAT PRATYUSH KAILAS NANDA	COMPUTE R ENGINEERING
439	SCS71	VAVIYA ANAND BECHARABAI GANGA	COMPUTE R ENGINEERING
440	SCS72	VELE DEVEN PRAMOD PRACHI	COMPUTE R ENGINEERING
441	SCS73	VERMA SANDEEP SURENDRA KIRAN	COMPUTE R ENGINEERING
442	TE01	AHIRE NISHIGANDA RAMESH ANITA	COMPUTE R ENGINEERING
443	TE02	AVALE RANJANA VINAYAK MEENABAI	COMPUTE R ENGINEERING
444	TE03	AWASKAR ELIAHOO JOEL PENNINA	COMPUTE R ENGINEERING
445	TE04	BADGUJAR MANASI SUNIL PRATHIBHA	COMPUTE R ENGINEERING
446	TE05	BANDAWANE TEJAS SUBHASH SANGITA	COMPUTE R ENGINEERING
447	TE06	BHANDARI RICHA SARITA	COMPUTE R ENGINEERING
448	TE07	BHOSEKAR PRANJAL PRADIP PRAJAKTA	COMPUTE R ENGINEERING
449	TE08	BORSE GAURI RAJENDRA SONALI	COMPUTE R ENGINEERING
450	TE09	CHAUDHARI DEEPA BHIMRAO DWARKA	COMPUTE R ENGINEERING
451	TE10	CHAVAN AJAY ARUN SULOCHANA	COMPUTE R ENGINEERING
452	TE11	CHAVAN KIRAN MHATARDEV RADHIKA	COMPUTE R ENGINEERING
453	TE12	CHAVAN SHUBHAM ANANDRAO SUNANDA	COMPUTE R ENGINEERING
454	TE13	CHAVAN VIKRAM NAMDEV PUTLIBAI	COMPUTE R ENGINEERING
455	TE14	DABHADE PRATIKSHA SARJERAO	COMPUTE R ENGINEERING
456	TE15	DABIR JITESH KASHINATH PRAVINA	COMPUTE R ENGINEERING
457	TE16	DALAVI JIVITESH MARUTI SARIKA	COMPUTE R ENGINEERING
458	TE17	DESHMUKH MAITHILI SURESH SHARMILA	COMPUTE R ENGINEERING
459	TE18	DHANAWADE MEGHA SHIVRAM LATA	COMPUTE R ENGINEERING
460	TE19	DHEMBRE SHWETALI APPASAHEB SAVITA	COMPUTE R ENGINEERING
461	TE20	DHUMAL JUILEE ROHIDAS SAVITA	COMPUTE R ENGINEERING
462	TE21	GANGANE TEJALI RAMESH JYOTI	COMPUTE R ENGINEERING
463	TE22	GHARAT SANDESH BHARAT REKHA	COMPUTE R ENGINEERING
464	TE23	GHOSH SOURABH NARAYAN BULA	COMPUTE R ENGINEERING
465	TE24	GUPTA SHRISTI GULAB AARTI	COMPUTE R ENGINEERING
466	TE25	JADHAV SHRADDHA SAMBHAJIRAO RAJASH	COMPUTE R ENGINEERING
467	TE26	JADHAV SHRADHA SHITAL SUVARNA	COMPUTE R ENGINEERING
468	TE27	JADHAV SHREYA SAMBHAJIRAO RAJASHRE	COMPUTE R ENGINEERING
469	TE28	KALEKAR JAGRUTI EKNATH PRANITA	COMPUTE R ENGINEERING
470	TE29	KAUSHIK RAJNISH PAWAN ANITA	COMPUTE R ENGINEERING
471	TE30	KOLI SHRADDHA JAGAN JAYA	COMPUTE R ENGINEERING
472	TE31	KUBAL SANIKA VILAS SWATI	COMPUTE R ENGINEERING
473	TE32	LOHAR AISHWARYA MAHADEO MINAKSHI	COMPUTE R ENGINEERING
474	TE33	MADHAVI PRADNYA DILIP PRABHAVATI	COMPUTE R ENGINEERING
475	TE34	MALI MAYURI MAHENDRA LALITA	COMPUTE R ENGINEERING
476	TE35	MAPARA JAFAR YASIN MEHNAAZ	COMPUTE R ENGINEERING
477	TE36	MISHRA SATYAPRAKASH NAVNEET SHOBH	COMPUTE R ENGINEERING
478	TE37	NAGLE TANVI PARAG PRIYANKA	COMPUTE R ENGINEERING

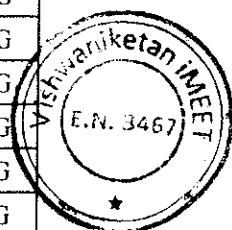

TRUE COPY

[Handwritten Signature]

Principal
Vishwaniketan's (IMET)

479	TE38	PACHPOR RAM SANJAY SEEMA	COMPUTE R ENGINEERING
480	TE39	PANCHAL DARSHANA SATISH SWARALI	COMPUTE R ENGINEERING
481	TE41	PASHILKAR MADHURA RAJENDRA UMA	COMPUTE R ENGINEERING
482	TE42	PATHAK SHAGUN SUDHISH SAVITA	COMPUTE R ENGINEERING
483	TE43	PATIL HARSHADA BHARAT PRATIBHA	COMPUTE R ENGINEERING
484	TE45	PATIL NEHA RAJESH MANISHA	COMPUTE R ENGINEERING
485	TE46	PATIL PRASAD SHANTARAM NANDA	COMPUTE R ENGINEERING
486	TE47	PATIL PRITI DEEPAK JYOTI	COMPUTE R ENGINEERING
487	TE48	PATIL Sampada Sanjay Sunita	COMPUTE R ENGINEERING
488	TE49	PATIL SANJOG SANJAY SUVARNA	COMPUTE R ENGINEERING
489	TE50	PATIL SHUBHAM PRADEEP JYOTI	COMPUTE R ENGINEERING
490	TE51	PATIL SNEHAL RAMCHANDRA SHEETAL	COMPUTE R ENGINEERING
491	TE52	PATIL VISHAL BHAGWAN GEETA	COMPUTE R ENGINEERING
492	TE53	RAMANE SAYALI ARVIND APARNA	COMPUTE R ENGINEERING
493	TE54	SAHANI SANJAY RAMAWADH FULDHARI	COMPUTE R ENGINEERING
494	TE55	SANKHE SAISH ANIL AMITA	COMPUTE R ENGINEERING
495	TE56	SAWANT RAJASHREE VASANT SANGITA	COMPUTE R ENGINEERING
496	TE57	SHAH PRANEET KIRAN POONAM	COMPUTE R ENGINEERING
497	TE58	SHARMA AARTI DEVIDAYAL SUMITRA	COMPUTE R ENGINEERING
498	TE59	SHETTY MANJUSH SANTOSH VANITHA	COMPUTE R ENGINEERING
499	TE60	SINGH ABHISHEK OMPRAKASH SUNITA	COMPUTE R ENGINEERING
500	TE61	SINGH POOJA KAMESHWAR KUMKUM	COMPUTE R ENGINEERING
501	TE62	SINGH SURUCHI SANTOSH SEEMA	COMPUTE R ENGINEERING
502	TE63	SOMWANSHI ADITYA ASHOK MANISHA	COMPUTE R ENGINEERING
503	TE64	SURVE DAMINI SUDHIR SMITA	COMPUTE R ENGINEERING
504	TE65	SURYAWANSHI RAHUL RAJENDRA REKHA	COMPUTE R ENGINEERING
505	TE66	THAKARE ASHWINI TULSHIRAM TARA	COMPUTE R ENGINEERING
506	TE67	TYAGI ISHITA UDYANKUMAR POONAM	COMPUTE R ENGINEERING
507	TE68	WAGHMARE PRITISH RAVINDRA CHHAYA	COMPUTE R ENGINEERING
508	TE69	WAKATI PRATIK SHESHNATH GEETANJALI	COMPUTE R ENGINEERING
509	TE70	WALKE MAHESH SANJAY MANGAL	COMPUTE R ENGINEERING
510	TE71	WANKHEDE SNEHA ANIL VANDANA	COMPUTE R ENGINEERING
511	TE72	YEWALE OMKAR VILAS VAISHALI	COMPUTE R ENGINEERING
512	BE01	BANDHU SHIVAM SUNILKUMAR	COMPUTE R ENGINEERING
513	BE02	BHALEKAR DIPTI HARIBHAU	COMPUTE R ENGINEERING
514	BE03	BHOSALE NAMRATA NITIN	COMPUTE R ENGINEERING
515	BE04	BODKE SHRIKANT SANTOSH	COMPUTE R ENGINEERING
516	BE05	BUDHALEKAR RAKHI K	COMPUTE R ENGINEERING
517	BE06	DIXIT VINAYAK CHANDRAKANT	COMPUTE R ENGINEERING
518	BE07	GHARAT MANASVI VILAS	COMPUTE R ENGINEERING
519	BE08	JADHAV VRUSHAB SATISH	COMPUTE R ENGINEERING
520	BE09	JESLA GEORGE	COMPUTE R ENGINEERING
521	BE10	JUWATKAR KALPASHREE GOVIND	COMPUTE R ENGINEERING
522	BE11	KADAM KOMAL TANAJI	COMPUTE R ENGINEERING

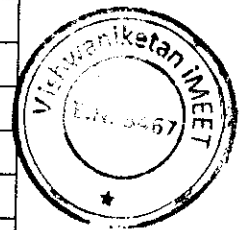

TRUE COPY

[Signature]
Principal
Vishwaniketan's (I MEET)

523	BE12	KADAM SHUBHAM RAMCHANDR	COMPUTE R ENGINEERING
524	BE13	KADAM AMRUTA DIHANANJAY	COMPUTE R ENGINEERING
525	BE14	KADAV SANDEEP SURESH	COMPUTE R ENGINEERING
526	BE15	KALAMBE AKSHAY RAJENDRA	COMPUTE R ENGINEERING
527	BE16	KAMLE PRATIK PRALHAD	COMPUTE R ENGINEERING
528	BE17	KARANDE ANKITA PRAKASH	COMPUTE R ENGINEERING
529	BE18	KATARIYA RISHABH MAHENDR.	COMPUTE R ENGINEERING
530	BE19	KOLI AJAY NANA	COMPUTE R ENGINEERING
531	BE20	KONDE AKSHAY DATTATRAY	COMPUTE R ENGINEERING
532	BE21	KUMBHAR ABHIJIT	COMPUTE R ENGINEERING
533	BE22	KURANGALE JAGRUTI BHARAT	COMPUTE R ENGINEERING
534	BE23	LOTE PAYAL SUNIL	COMPUTE R ENGINEERING
535	BE24	LOTE PUJA RAJENDRA	COMPUTE R ENGINEERING
536	BE25	MARATHE PADMAJA NARENDRA	COMPUTE R ENGINEERING
537	BE26	MHATRE PRADNYA SHASHIKAN	COMPUTE R ENGINEERING
538	BE28	MITHARI SAURABH GAJANAN	COMPUTE R ENGINEERING
539	BE29	MUNOT SHREYASH SUNIL	COMPUTE R ENGINEERING
540	BE30	PAGADE MINAL VASANT	COMPUTE R ENGINEERING
541	BE31	PALAVE ANIKET NIVRUTTI	COMPUTE R ENGINEERING
542	BE32	PATIL POOJA BALKRISHNA	COMPUTE R ENGINEERING
543	BE33	PATIL PRADNYA BHAGWAN	COMPUTE R ENGINEERING
544	BE34	PATIL SNEHAL PRATAP	COMPUTE R ENGINEERING
545	BE35	PATIL SUPRIYA VILAS	COMPUTE R ENGINEERING
546	BE36	RAHATE SHUBHANKAR DILIP	COMPUTE R ENGINEERING
547	BE37	ROMINA MANOJ NARAYANLAL	COMPUTE R ENGINEERING
548	BE38	SHAIKH KAMIL SUMAIR	COMPUTE R ENGINEERING
549	BE39	SHENDE NAMRATA RAMAKAN	COMPUTE R ENGINEERING
550	BE40	SINGH SONALI SHAILENDRA	COMPUTE R ENGINEERING
551	BE41	SURYAVANSHI VIKAS SHIVAJI	COMPUTE R ENGINEERING
552	BE42	THOMBARE PRABODH ANIL	COMPUTE R ENGINEERING
553	BE43	THOSAR ANIKET VINAYAK	COMPUTE R ENGINEERING
554	BE44	TILEKAR AJAY MOHAN	COMPUTE R ENGINEERING
555	SE01	AMBAVANE AMRUTA MANOJ	ELECTRICAL ENGINEERING
556	SE02	ANDHARE SHUBHAM DEVENDR	ELECTRICAL ENGINEERING
557	SE03	AWASKAR ROSHAN HIRAMAN	ELECTRICAL ENGINEERING
558	SE04	BAILMARE SAMIDHA RAVINDR	ELECTRICAL ENGINEERING
559	SE05	BHOIR NARAYAN PUNDLIK	ELECTRICAL ENGINEERING
560	SE06	BHOIR PRATHAMESH PARSHUR	ELECTRICAL ENGINEERING
561	SE07	BHOIR SHIVANI MAHESH ARCI	ELECTRICAL ENGINEERING
562	SE08	BHOIR SHIVANI MAHESH ARCI	ELECTRICAL ENGINEERING
563	SE09	BHOPI NIKHIL BHAGVAN	ELECTRICAL ENGINEERING
564	SE10	BIDRE PRASAD DILIP	ELECTRICAL ENGINEERING
565	SE11	CHAVAN AJAY SHIVAJI	ELECTRICAL ENGINEERING
566	SE12	DALVI RUSHIKESH NARESH	ELECTRICAL ENGINEERING

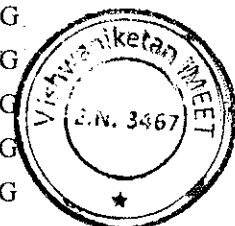

TRUE COPY

[Signature]

Principal

Vishwaniketan's (I MEET)

567	SE13	DESHMUKH VAIBHAV HARISHCHANDRA	ELECTRICAL ENGINEERING
568	SE14	DHAYAGUDE KUNAL RAVINDRA	ELECTRICAL ENGINEERING
569	SE15	DHUMAL MANOHAR ASHOK	ELECTRICAL ENGINEERING
570	SE16	DUBE RASHIKA VILAS	ELECTRICAL ENGINEERING
571	SE17	GADE PRATIK SAVLARAM	ELECTRICAL ENGINEERING
572	SE18	GAIKWAD SUMIT SHAHAJI	ELECTRICAL ENGINEERING
573	SE19	GAMBHIR SAURABH VISHWAS	ELECTRICAL ENGINEERING
574	SE20	GHARGE ARCHANA	ELECTRICAL ENGINEERING
575	SE21	JAITU ADITYA	ELECTRICAL ENGINEERING
576	SE22	JOSHI RAHUL SUBHAKAR	ELECTRICAL ENGINEERING
577	SE23	KANGE DIPTI LAXMAN SANGEETA	ELECTRICAL ENGINEERING
578	SE24	KARDE YUVRAJ BHALCHANDRA	ELECTRICAL ENGINEERING
579	SE25	KOLEKAR BHAGYASHREE HARI	ELECTRICAL ENGINEERING
580	SE26	KUSHWAHA AAKASH	ELECTRICAL ENGINEERING
581	SE27	KUTHE TUSHAR KAMALAKAR LATA	ELECTRICAL ENGINEERING
582	SE28	LOHAR AMISH VIJAY MANISHA	ELECTRICAL ENGINEERING
583	SE29	LOLE NIKITA SURESH	ELECTRICAL ENGINEERING
584	SE30	MAHATO KRISHNA	ELECTRICAL ENGINEERING
585	SE31	MANE DEVYANI SANJAY	ELECTRICAL ENGINEERING
586	SE32	MANER ALPESH ASHOK	ELECTRICAL ENGINEERING
587	SE33	MHASKE AKASH MHATARBA	ELECTRICAL ENGINEERING
588	SE34	MHATRE HARSHAL DATTATRAY	ELECTRICAL ENGINEERING
589	SE35	MHATRE KARAN	ELECTRICAL ENGINEERING
590	SE36	MHATRE NIPUN DEVANAND	ELECTRICAL ENGINEERING
591	SE37	MHATRE RUCHITA LASHINATH	ELECTRICAL ENGINEERING
592	SE38	MHATRE SAGAR KASHINATH	ELECTRICAL ENGINEERING
593	SE39	MISHRA KARUNANAND MANOJ	ELECTRICAL ENGINEERING
594	SE40	MOKAL DAKSHATA DASHARATH	ELECTRICAL ENGINEERING
595	SE41	MOKAL VAISHNAVI VISHWANATH	ELECTRICAL ENGINEERING
596	SE42	MORE CHITRANG VIJAY VRUSHALI	ELECTRICAL ENGINEERING
597	SE43	MORE SUMIT SUNIL	ELECTRICAL ENGINEERING
598	SE44	MUNDHE MAYUR BHIM	ELECTRICAL ENGINEERING
599	SE45	OVHAL PRATIK PRABHAKAR	ELECTRICAL ENGINEERING
600	SE46	PANDIT SHREELESH SHARAD	ELECTRICAL ENGINEERING
601	SE47	PATIL ABHILASH CHANDRAKANT	ELECTRICAL ENGINEERING
602	SE48	PATIL ARPITA SHRIDHAR	ELECTRICAL ENGINEERING
603	SE49	PATIL JAYESH SANJAY	ELECTRICAL ENGINEERING
604	SE50	PATIL NIKET	ELECTRICAL ENGINEERING
605	SE51	PATIL PRADNYA PANDURANG	ELECTRICAL ENGINEERING
606	SE52	PATIL PRAJYOTI LAXMAN CHARUSHILA	ELECTRICAL ENGINEERING
607	SE53	PATIL PRITESH PRABHAKAR	ELECTRICAL ENGINEERING
608	SE54	PATIL RUSHIKESH BABAN	ELECTRICAL ENGINEERING
609	SE55	PATIL SAHIL SOPAN DHARTI	ELECTRICAL ENGINEERING
610	SE56	PATIL SHUBHAM BALARAM	ELECTRICAL ENGINEERING

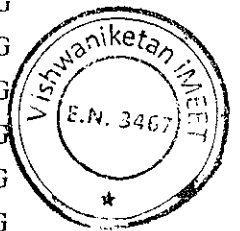

TRUE COPY

[Signature]

Principal

Vishwaniketan's (I MEET)

611	SE57	PATIL SHUBHAM HARIBHAU	ELECTRICAL ENGINEERING
612	SE58	PATIL SUMIT SANJAY NEHA	ELECTRICAL ENGINEERING
613	SE59	PATIL TEJAS CHANDRAKANT	ELECTRICAL ENGINEERING
614	SE60	PATIL VISHANT DEVIDAS	ELECTRICAL ENGINEERING
615	SE61	PAWAR MANGESH ANKUSH	ELECTRICAL ENGINEERING
616	SE62	PAWAR NITISH BHIMRAO	ELECTRICAL ENGINEERING
617	SE63	PHADKE AMEYA ANAND AARATI	ELECTRICAL ENGINEERING
618	SE64	PINGALE JAY KASHINATH	ELECTRICAL ENGINEERING
619	SE65	PINGALE PRIYANKA KRUSHINA DEEPA	ELECTRICAL ENGINEERING
620	SE66	RAJHANS ANKII RAVINDRA	ELECTRICAL ENGINEERING
621	SE67	RATHOD ABHAY DINESH SINGH	ELECTRICAL ENGINEERING
622	SE68	RAUT SAIRAJ SUNIL	ELECTRICAL ENGINEERING
623	SE69	RAUT SAURABH	ELECTRICAL ENGINEERING
624	SE70	SAKPAL ONKAR PRADEEP	ELECTRICAL ENGINEERING
625	SE71	SATRE HARSHADA VIJAY	ELECTRICAL ENGINEERING
626	SE72	SAVAGAVE SHRAVAN SATISH	ELECTRICAL ENGINEERING
627	SE73	SAWANT AMEYA	ELECTRICAL ENGINEERING
628	SE74	SHINDE MILIND KISHOR ALKA	ELECTRICAL ENGINEERING
629	SE75	SHINGRUT ROSHANI SANJAY	ELECTRICAL ENGINEERING
630	SE76	SHIRKE SHUBHAM SUDESH	ELECTRICAL ENGINEERING
631	SE77	SINGH YASH SHRAVAN	ELECTRICAL ENGINEERING
632	SE78	SUTAR NIKHIL KISHOR	ELECTRICAL ENGINEERING
633	SE79	TAYDE NILESH PUNJAJI NIMALA	ELECTRICAL ENGINEERING
634	SE80	THAKUR AKHIL	ELECTRICAL ENGINEERING
635	SE81	THOMBARE PRIYANKA CHANDRAKANT	ELECTRICAL ENGINEERING
636	SE82	TIWARI SAURABH RAGHAVENDRA	ELECTRICAL ENGINEERING
637	SE83	TUPE OMKAR ASHOK	ELECTRICAL ENGINEERING
638	SE84	UBHARE RIHIT RAMDAS	ELECTRICAL ENGINEERING
639	SE85	WADE SANKET RAJENDRA	ELECTRICAL ENGINEERING
640	SE86	YADAV AWDHESH KUMAR SEVA	ELECTRICAL ENGINEERING
641	TE01	/ADOLE APURVA SUKHDEV SANJIVANI	ELECTRICAL ENGINEERING
642	TE02	BAKKAR NIMISH BALKRISHNA	ELECTRICAL ENGINEERING
643	TE03	BARAD YOGESH SUNIL BHARTI	ELECTRICAL ENGINEERING
644	TE04	BHATKAR PRATHAMESH DILIP DIPIKA	ELECTRICAL ENGINEERING
645	TE05	BHAYE BHUSHAN ARVIND URMILA	ELECTRICAL ENGINEERING
646	TE06	BHIDE SWANAND SHRIKANT MADHURA	ELECTRICAL ENGINEERING
647	TE07	BHISE ARJUN TUKARAM PRITI	ELECTRICAL ENGINEERING
648	TE08	BHOIR ASHUTOSH SHAMRAV SHILPA	ELECTRICAL ENGINEERING
649	TE09	BHOSALE UDAY SANJAY SANJIVANI	ELECTRICAL ENGINEERING
650	TE10	BORUDE SAGAR AMBADAS TARABAI	ELECTRICAL ENGINEERING
651	TE11	CHALKE DHEERAJ VASANT RANJANA	ELECTRICAL ENGINEERING
652	TE12	CHANDORKAR KUNAL MUKUND MEENA	ELECTRICAL ENGINEERING
653	TE13	DALVI SANKET SANTOSH SUJATA	ELECTRICAL ENGINEERING
654	TE14	DALVI VIRAJ SANTOSH SHARADA	ELECTRICAL ENGINEERING



TRUE COPY

[Handwritten Signature]

Principal

Vishwaniketan's (I) MEET

655	TE15	DESAI SURAJ VITTHAL SAVITA	ELECTRICAL ENGINEERING
656	TE16	DESHMUKH SAURABH DNYANESHWAR	ELECTRICAL ENGINEERING
657	TE17	/DESHMUKH SHILPA SHRIKANT ALAKA	ELECTRICAL ENGINEERING
658	TE18	DOIPHODE PANKAJ BHIM POURNIMA	ELECTRICAL ENGINEERING
659	TE19	FOFERKAR PRANAY VILAS PRAFULLA	ELECTRICAL ENGINEERING
660	TE20	GAIKWAD VAIBHAV SIDDHARTH SUNITA	ELECTRICAL ENGINEERING
661	TE21	/GHARAT DAMINI SANTOSH BHARTI	ELECTRICAL ENGINEERING
662	TE22	GHARATKAR SIDDESH VIKAS SANJIVANI	ELECTRICAL ENGINEERING
663	TE23	GHIYATADAK SUMIT SHAMRAO SUJATA	ELECTRICAL ENGINEERING
664	TE24	GHUDE HARSHAL MANOHAR SANGITA	ELECTRICAL ENGINEERING
665	TE25	GURAV PRANAY PRASHANT	ELECTRICAL ENGINEERING
666	TE26	/GIRI ARATI NARENDRA SNEHA	ELECTRICAL ENGINEERING
667	TE27	INCHANALKAR POOJA BAPUSAHEB	ELECTRICAL ENGINEERING
668	TE28	JADHAV RAJKUMAR YUVRAJ MANGALA	ELECTRICAL ENGINEERING
669	TE29	JADHAV SURAJ DHONDURAM PRIYANKA	ELECTRICAL ENGINEERING
670	TE30	JADHAV SURAJ SUNIL VANDANA	ELECTRICAL ENGINEERING
671	TE31	JAMDADE VISHAL DHONDIRAM JANNABAI	ELECTRICAL ENGINEERING
672	TE32	KADAM ASHWINKUMAR ASHOK SWATI	ELECTRICAL ENGINEERING
673	TE33	KAKAD SAGAR SUBHASH PUSHPA	ELECTRICAL ENGINEERING
674	TE34	/KOLI SONALI SUNIL SUREKHA	ELECTRICAL ENGINEERING
675	TE35	KOLI SUMIT RAJU DHANWANTI	ELECTRICAL ENGINEERING
676	TE36	LOHOT HRISHIKESH BALU LALITA	ELECTRICAL ENGINEERING
677	TE37	MAHIMKAR ABHISHEK SAMEER	ELECTRICAL ENGINEERING
678	TE38	/MAITY SUDEEPA SUBODH DEEPA	ELECTRICAL ENGINEERING
679	TE39	MHATRE CHETAN KIRAN DYAMANTI	ELECTRICAL ENGINEERING
680	TE40	MHATRE MANDAR RAMAKANT RESHMA	ELECTRICAL ENGINEERING
681	TE41	MHATRE SHEKAHAR KASHINATH NANDA	ELECTRICAL ENGINEERING
682	TE42	MIRGAL PARESH MANOHAR MADHURI	ELECTRICAL ENGINEERING
683	TE43	MORE HARISH ANKUSH LATA	ELECTRICAL ENGINEERING
684	TE44	MULIK MAYUR KRISHNARAO BHARATI	ELECTRICAL ENGINEERING
685	TE45	NARSINGH APURV DHARMENDRA	ELECTRICAL ENGINEERING
686	TE46	PANDEY GAURAV BIRENDRA PUSHPA	ELECTRICAL ENGINEERING
687	TE47	PANDEY ROUSHAN VIJAY RANJU	ELECTRICAL ENGINEERING
688	TE48	/PANSANDE SWAPNALI	ELECTRICAL ENGINEERING
689	TE49	PARINGE NITESH BHAGA SUNITA	ELECTRICAL ENGINEERING
690	TE50	PARULEKAR ADITYA SURENDRA SUVARNA	ELECTRICAL ENGINEERING
691	TE51	PATIL AJINKYA DAYANAND MANISHA	ELECTRICAL ENGINEERING
692	TE52	PATIL AKSHAY JANARDAN ANITA	ELECTRICAL ENGINEERING
693	TE53	/PATIL ANKITA GANPAT NITA	ELECTRICAL ENGINEERING
694	TE54	/PATIL CHETNA BHAGWAN ARCHANA	ELECTRICAL ENGINEERING
695	TE55	PATIL GOKUL RAMESH NANDA	ELECTRICAL ENGINEERING
696	TE56	PATIL HARSHAL KAMLESH RUPALI	ELECTRICAL ENGINEERING
697	TE57	PATIL MINAL MACHHINDRANATH	ELECTRICAL ENGINEERING
698	TE58	PATIL VINAYAK DHONDIBA GEETA	ELECTRICAL ENGINEERING



TRUE COPY

[Signature]
Principal

Vishwaniketan's (I.M.E.E.T)

699	TE59	PAWAR SHUBHAM KASHINATH VANITA	ELECTRICAL ENGINEERING
700	TE60	PENKAR AMIR REFAYAL SARA	ELECTRICAL ENGINEERING
701	TE61	/RAUT VISHAKHA PRABHAKAR PRAJAKTA	ELECTRICAL ENGINEERING
702	TE62	SALUNKE VINAYAK TANAJI NANDA	ELECTRICAL ENGINEERING
703	TE63	/SALVE DIKSHA SHASHIKANT RAJANI	ELECTRICAL ENGINEERING
704	TE64	SANKLECHA MAHIL ARAVIND KAVITA	ELECTRICAL ENGINEERING
705	TE65	SHELAR SHUBHAM SANTOSH MANGAL	ELECTRICAL ENGINEERING
706	TE66	SHELKE NILESH VILAS GANGUBAI	ELECTRICAL ENGINEERING
707	TE67	SHINDE AKSHAY DIPAK MANISHA	ELECTRICAL ENGINEERING
708	TE68	SINGH AJEET KUMAR SATISH SUMAN	ELECTRICAL ENGINEERING
709	TE69	TAMBAT SAGAR SHANTARAM VIDYA	ELECTRICAL ENGINEERING
710	TE70	TARU JAYESH NAMDEV NAMRATA	ELECTRICAL ENGINEERING
711	TE71	TAYADE SAGAR SHASHIKANT UJJAWALA	ELECTRICAL ENGINEERING
712	TE72	/THAKUR KISHORI SHRIKRISHNA	ELECTRICAL ENGINEERING
713	TE73	TODANKAR KRUNAL CHANDRAKANT	ELECTRICAL ENGINEERING
714	TE74	WADKE HARSHAL RAMESH RASHMI	ELECTRICAL ENGINEERING
715	TE75	WAGH ANIKET BALU NEETA	ELECTRICAL ENGINEERING
716	TE76	WATWE AKSHAY SUNIL SHALINI	ELECTRICAL ENGINEERING
717	TE77	/ZIMBAL KOMAL VASANT SUVARNA	ELECTRICAL ENGINEERING
718	BE01	AWARI ANIL ANANT KAMAL	ELECTRICAL ENGINEERING
719	BE02	BARAI SURAJ JAYPRASAD PRAMILA	ELECTRICAL ENGINEERING
720	BE03	BHADORIYA MANMOHAN SINGH	ELECTRICAL ENGINEERING
721	BE04	/BHOSALE SIDDHI SHARAD JYOTI	ELECTRICAL ENGINEERING
722	BE05	/CHAVAN NEHA MANGESH SANDHYA	ELECTRICAL ENGINEERING
723	BE06	CHAVAN SHRINIVAS RAMCHANDRA	ELECTRICAL ENGINEERING
724	BE07	CHEVALE PRASAD ANIL ASMITA	ELECTRICAL ENGINEERING
725	BE08	DESHMUKH AVINASH PRADIP PRAMILA	ELECTRICAL ENGINEERING
726	BE09	DHAIGUDE PRAMOD BUVASO CHHAYA	ELECTRICAL ENGINEERING
727	BE10	DHONDE SURAJ MARUTI JAYSHREE	ELECTRICAL ENGINEERING
728	BE11	DUBEY YOGESHWAR DEENANATH	ELECTRICAL ENGINEERING
729	BE12	FIRAKE SHUBHAM SHRINIWAS PUSHPA	ELECTRICAL ENGINEERING
730	BE13	/GAIKWAD PRIYANKA BHAURAO JYOTI	ELECTRICAL ENGINEERING
731	BE14	GHANVAT NIKHIL BALU SUREKHA	ELECTRICAL ENGINEERING
732	BE15	/GHOLAP MAYURI ASHOK SANGITA	ELECTRICAL ENGINEERING
733	BE16	HOTKAR AKSHAY ARUN SINDHU	ELECTRICAL ENGINEERING
734	BE17	JADHAV AKSHAY YASHWANT MALATEE	ELECTRICAL ENGINEERING
735	BE18	JADHAV SHUBHAM GAJANAN SANGITA	ELECTRICAL ENGINEERING
736	BE19	KACHARE REVNATH GOPAL GEETA	ELECTRICAL ENGINEERING
737	BE20	KAMTHE AKSHAY NAGESH MANISHA	ELECTRICAL ENGINEERING
738	BE21	KHOT GANESH KESHAV SAKHUTAI	ELECTRICAL ENGINEERING
739	BE22	KONDUSKAR CHANDRAKANT ARUN	ELECTRICAL ENGINEERING
740	BE23	/LANGI SUPRIYA SURESH USHA	ELECTRICAL ENGINEERING
741	BE24	MAHALE ASHWIN ARUN SHOBHA	ELECTRICAL ENGINEERING
742	BE25	MANE RAHUL DHANAJI SHOBHA	ELECTRICAL ENGINEERING



TRUE COPY

[Handwritten Signature]

Principal
Vishwaniketan Institute

743	BE26	MORE VIKAS SHIVRAM SUSHILA	ELECTRICAL ENGINEERING
744	BE27	NAIR KRISHNAPRASAD MOHAN USHA	ELECTRICAL ENGINEERING
745	BE28	NALAWADE PRATHAMESH ANANDRAW	ELECTRICAL ENGINEERING
746	BE29	NIRAJ MITHLESH GEETA	ELECTRICAL ENGINEERING
747	BE30	OMALE AKSHAY BHIKAJI SUNITA	ELECTRICAL ENGINEERING
748	BE31	PARDESHI SANTOSH JANKIRAM PUSHPA	ELECTRICAL ENGINEERING
749	BE32	PATEKAR BIHARAT PANDUPANG	ELECTRICAL ENGINEERING
750	BE33	PATIL ANIKET TATOBA SUJATA	ELECTRICAL ENGINEERING
751	BE34	PATIL SATEJ RAMAKANT SARIKA	ELECTRICAL ENGINEERING
752	BE35	PURI SURAJ RAJESH GAYATRI	ELECTRICAL ENGINEERING
753	BE36	RAJPURE PRITAM SAVLARAM CHHAYA	ELECTRICAL ENGINEERING
754	BE37	RASAL PRUTHVIRAJ DINKAR DROPADI	ELECTRICAL ENGINEERING
755	BE38	SALUNKHE PRATHMESH ASHOK VANITA	ELECTRICAL ENGINEERING
756	BE39	SAWANT ANIL DATTATRAY MANGAL	ELECTRICAL ENGINEERING
757	BE40	SAWANT PRATHAMESH MANOJ MEGHANA	ELECTRICAL ENGINEERING
758	BE41	SHELAR ATUL RAMESH SANGEETA	ELECTRICAL ENGINEERING
759	BE42	SHINDE ADITYA UDDHAV SAVITA	ELECTRICAL ENGINEERING
760	BE43	/SHINDE SUKANYA SUDHAKAR SUMITRA	ELECTRICAL ENGINEERING
761	BE44	SINGH AKASH ASHOK ANITA	ELECTRICAL ENGINEERING
762	BE45	SINGH ATHARV BHUPENDRA SUMAN	ELECTRICAL ENGINEERING
763	BE46	SONAR ASHOK DHANSINGH CHANDADEV	ELECTRICAL ENGINEERING
764	BE47	TANDEL MANISH BALIRAM KALPANA	ELECTRICAL ENGINEERING
765	BE48	VHARE SAMBHAJI PANDURANG PHULABAI	ELECTRICAL ENGINEERING
766	BE49	WARGUDE VAIBHAV KRUSHNA USHA	ELECTRICAL ENGINEERING
767	SE01	AWASKAR SAYALI BHARAT	ELECTRONICS AND TELECOMMUNICA
768	SE02	BAMBORI PRATIKSHA CHETANKUMAR	ELECTRONICS AND TELECOMMUNICA
769	SE03	BANGAR SHUBHAM VIVEKANAND	ELECTRONICS AND TELECOMMUNICA
770	SE04	BHALERAO SHUBHAM SANJAY	ELECTRONICS AND TELECOMMUNICA
771	SE05	BODEKAR ARATI BALU	ELECTRONICS AND TELECOMMUNICA
772	SE06	DESAI HRUSHIKESH RAJENDRA	ELECTRONICS AND TELECOMMUNICA
773	SE07	DESAI PRIYANKA ARUN	ELECTRONICS AND TELECOMMUNICA
774	SE08	GIRI SAKSHI GAJANAN	ELECTRONICS AND TELECOMMUNICA
775	SE09	ITHAPE PRIYANKA RAJARAM	ELECTRONICS AND TELECOMMUNICA
776	SE10	JAMBHALE PRERANA DINKAR	ELECTRONICS AND TELECOMMUNICA
777	SE11	KHOT AKSHAY VISHNU [TFWS]	ELECTRONICS AND TELECOMMUNICA
778	SE12	MALI PRANJALI VIJAYKUMAR	ELECTRONICS AND TELECOMMUNICA
779	SE13	MANDAVKAR SOURABH SANJAY	ELECTRONICS AND TELECOMMUNICA
780	SE14	MHATRE SUVIDHA SAROJKUMAR	ELECTRONICS AND TELECOMMUNICA
781	SE15	MHATRE VIKRANTI MANGESH	ELECTRONICS AND TELECOMMUNICA
782	SE16	MISHRA KESHAV HARISH	ELECTRONICS AND TELECOMMUNICA
783	SE17	MORE PRATIKSHA DILIP	ELECTRONICS AND TELECOMMUNICA
784	SE18	PANDIT SANDESH PRAKASH	ELECTRONICS AND TELECOMMUNICA
785	SE19	PATIL NIDHI VINIT	ELECTRONICS AND TELECOMMUNICA
786	SE20	PATIL SHARAYU SHANKAR	ELECTRONICS AND TELECOMMUNICA



TRUE COPY

[Signature]

787	SE21	SALVEKAR PRATIKSHA PRASHANT	ELECTRONICS AND TELECOMMUNICA
788	SE22	SALVI SAYALI SANDESH	ELECTRONICS AND TELECOMMUNICA
789	SE23	SHELKE TITIKSHA CHANGDEV	ELECTRONICS AND TELECOMMUNICA
790	SE24	SHILMKAR PRATIKSHA MANOHAR	ELECTRONICS AND TELECOMMUNICA
791	SE25	SHINDE MINAL MAHESH MAYURI	ELECTRONICS AND TELECOMMUNICA
792	SE26	SHIVALE MINAL SHIVAJI	ELECTRONICS AND TELECOMMUNICA
793	SE27	SONAWALE AJINKYA SUBHASH	ELECTRONICS AND TELECOMMUNICA
794	SE28	UGALE PRATIKSHA ANIL	ELECTRONICS AND TELECOMMUNICA
795	SE29	VALMIK ERESHWARI MALLESH	ELECTRONICS AND TELECOMMUNICA
796	SE30	WAIGUDE APEKSHA VIKAS	ELECTRONICS AND TELECOMMUNICA
797	SE31	WANI SIMRAN KRISHNANATH	ELECTRONICS AND TELECOMMUNICA
798	SE32	YADAV GEETA BALKISHAN	ELECTRONICS AND TELECOMMUNICA
799	SE33	DASWADKAR MILIND JANARDAN	ELECTRONICS AND TELECOMMUNICA
800	TE 01	BHILARE KIRAN MUGUT	ELECTRONICS AND TELECOMMUNICA
801	TE 02	BHOSALE POONAM RAMESH	ELECTRONICS AND TELECOMMUNICA
802	TE 03	CHOUGULE GURURAJ CHANDRASHEKHAR	ELECTRONICS AND TELECOMMUNICA
803	TE 04	DESHMUKH VIRAJ RAJENDRA	ELECTRONICS AND TELECOMMUNICA
804	TE 05	DESHPANDE PARTH MAKARAND	ELECTRONICS AND TELECOMMUNICA
805	TE 06	DHIGARE AKSHAY ANANDA	ELECTRONICS AND TELECOMMUNICA
806	TE 07	DONGARE AKSHAY ROHIDAS	ELECTRONICS AND TELECOMMUNICA
807	TE 08	GAUND SURAJ AJIT	ELECTRONICS AND TELECOMMUNICA
808	TE 09	GOLE PRANALI ARJUN	ELECTRONICS AND TELECOMMUNICA
809	TE 10	GURAV JATIN MAHESH	ELECTRONICS AND TELECOMMUNICA
810	TE 11	HARPUDE VRHUSHABH GAJANAN	ELECTRONICS AND TELECOMMUNICA
811	TE 12	ISHWARE TUSHAR ARVIND	ELECTRONICS AND TELECOMMUNICA
812	TE 13	JANGAM ABHISHEK SHRIKANT	ELECTRONICS AND TELECOMMUNICA
813	TE 14	KADAM DIPASHRI DILIP	ELECTRONICS AND TELECOMMUNICA
814	TE 15	KADAM OMKAR ARVIND	ELECTRONICS AND TELECOMMUNICA
815	TE 16	KADU BHAKTI VILAS	ELECTRONICS AND TELECOMMUNICA
816	TE 17	KAVALE KUNAL ASHISH	ELECTRONICS AND TELECOMMUNICA
817	TE 18	KOKAMBE KIRAN BABAN	ELECTRONICS AND TELECOMMUNICA
818	TE 19	KONT ANUJ ANAND	ELECTRONICS AND TELECOMMUNICA
819	TE 20	KURANE AARTI RAVINDRA	ELECTRONICS AND TELECOMMUNICA
820	TE 21	MAITY INDRAJIT NARENDRA	ELECTRONICS AND TELECOMMUNICA
821	TE 22	MANDLEKAR ASAVARI ANIL	ELECTRONICS AND TELECOMMUNICA
822	TE 23	MANE PUNAM JALINDAR	ELECTRONICS AND TELECOMMUNICA
823	TE 24	MHATRE SUPRIYA CHANDRAKANT	ELECTRONICS AND TELECOMMUNICA
824	TE 25	MHATRE VIKRANT DINANATH	ELECTRONICS AND TELECOMMUNICA
825	TE 26	MISHRA NITIN AKHILESH	ELECTRONICS AND TELECOMMUNICA
826	TE 27	MOKAL AKSHAY NAMDEV	ELECTRONICS AND TELECOMMUNICA
827	TE 28	MOKASHI YASH PRASHANT	ELECTRONICS AND TELECOMMUNICA
828	TE 29	MORE SURAJ SATISH	ELECTRONICS AND TELECOMMUNICA
829	TE 30	MUKADAM SARVESH MAHENDRA	ELECTRONICS AND TELECOMMUNICA
830	TE 31	NAIK RASHMITHA JAYANAND	ELECTRONICS AND TELECOMMUNICA

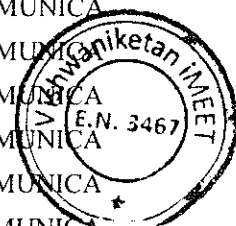

TRUE COPY

Principals
Vishwaniketan's (I) MBET

831	TE 32	NIKAM DHANASHREE VILAS	ELECTRONICS AND TELECOMMUNICA
832	TE 33	NIKAM SAGAR MADHUKAR	ELECTRONICS AND TELECOMMUNICA
833	TE 34	PATIL ABHEET ARVIND	ELECTRONICS AND TELECOMMUNICA
834	TE 35	PATIL ADITYA DEVIDAS	ELECTRONICS AND TELECOMMUNICA
835	TE 36	PATIL NAMRATA VILAS	ELECTRONICS AND TELECOMMUNICA
836	TE 37	PATIL PRIYANKA RAMCHANDRA	ELECTRONICS AND TELECOMMUNICA
837	TE 38	PATIL TEJAS VILAS	ELECTRONICS AND TELECOMMUNICA
838	TE 39	PAWAR JITESH CHAMPALAL	ELECTRONICS AND TELECOMMUNICA
839	TE 40	RAJPURKAR PRATIKSIA KRUSHNA	ELECTRONICS AND TELECOMMUNICA
840	TE 41	RATHOD POOJA NAMDEV	ELECTRONICS AND TELECOMMUNICA
841	TE 42	SAHU JANKIDEVI SHIVPRASAD	ELECTRONICS AND TELECOMMUNICA
842	TE 43	SALVI PRATHAMESH BHASKAR	ELECTRONICS AND TELECOMMUNICA
843	TE 44	SHINDE SURAJ SANJAY	ELECTRONICS AND TELECOMMUNICA
844	TE 45	SHRIGIRI KARAN DATTATRAYA	ELECTRONICS AND TELECOMMUNICA
845	TE 46	SHRIVASTAVA RISHAV ASHOK	ELECTRONICS AND TELECOMMUNICA
846	TE 47	SHRIVASTAVA SAURABH RAJKUMAR	ELECTRONICS AND TELECOMMUNICA
847	TE 48	SINGH ARJUN RAJIVLOCHAN	ELECTRONICS AND TELECOMMUNICA
848	TE 49	VASHISHTH NAMAN DINESH	ELECTRONICS AND TELECOMMUNICA
849	TE 50	WAIKAR SNEHAL PRABHAKAR	ELECTRONICS AND TELECOMMUNICA
850	TE 51	BHOSALE ANIKET GANPAT	ELECTRONICS AND TELECOMMUNICA
851	TE 52	CHAVAN MEHUL SURESH	ELECTRONICS AND TELECOMMUNICA
852	TE 53	GONDHALI SWAPNIL DHANAJI	ELECTRONICS AND TELECOMMUNICA
853	TE 54	PAWAR SAI GANESH	ELECTRONICS AND TELECOMMUNICA
854	BE 01	AWALE VISHAL VITTHAL	ELECTRONICS AND TELECOMMUNICA
855	BE 02	/BHINGARKAR SNEHA DAMAJI	ELECTRONICS AND TELECOMMUNICA
856	BE 03	BHUTAL SAGAR HINDURAM	ELECTRONICS AND TELECOMMUNICA
857	BE 04	/BIRAJDAR SNEHAL HANMANT	ELECTRONICS AND TELECOMMUNICA
858	BE 05	CHAVAN KETAN SARJERAO	ELECTRONICS AND TELECOMMUNICA
859	BE 06	/DALVI PRANALI PANDURANG	ELECTRONICS AND TELECOMMUNICA
860	BE 07	/DAS SNEHA RAJU JAYASHEELA	ELECTRONICS AND TELECOMMUNICA
861	BE 08	DAVLE VILAS MADHUKAR	ELECTRONICS AND TELECOMMUNICA
862	BE 09	DESHMUKH SHRADHA UDDHAV	ELECTRONICS AND TELECOMMUNICA
863	BE 10	DOUNT ANIKET CHANDRAKANT	ELECTRONICS AND TELECOMMUNICA
864	BE 11	/GAIKWAD TEJASHRI SADASHIV	ELECTRONICS AND TELECOMMUNICA
865	BE 12	/GAWAND SUVIDHA SANDIP	ELECTRONICS AND TELECOMMUNICA
866	BE 13	/GIRAMKAR HARSHADA KAILAS	ELECTRONICS AND TELECOMMUNICA
867	BE 14	GIRI RAJ SHIVKUMAR	ELECTRONICS AND TELECOMMUNICA
868	BE 15	/JANE MONALI RAJENDRA	ELECTRONICS AND TELECOMMUNICA
869	BE 16	/KARDE MAYURI BABURAO	ELECTRONICS AND TELECOMMUNICA
870	BE 17	/KHAMBAL SHRADHA MARUTI	ELECTRONICS AND TELECOMMUNICA
871	BE 18	KONA SAI DURGAPRASAD	ELECTRONICS AND TELECOMMUNICA
872	BE 19	KUMBHAR SURAJ SANJAY	ELECTRONICS AND TELECOMMUNICA
873	BE 20	/MHATRE EKATA JAYGUN	ELECTRONICS AND TELECOMMUNICA
874	BE 21	MHATRE SUDIN MORESHWAR	ELECTRONICS AND TELECOMMUNICA

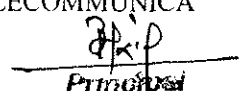

TRUE COPY

Principal
Vishwaniketan's (i MEET)

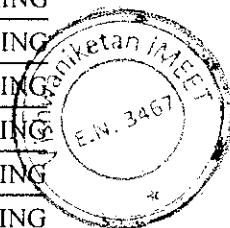
875	BE 22	PAIL WAN SUNNY KUNJAN	ELECTRONICS AND TELECOMMUNICA
876	BE 23	PAL MAHESHKUMAR PARASNATHI	ELECTRONICS AND TELECOMMUNICA
877	BE 24	PATIL AKSHAY VITHOBA	ELECTRONICS AND TELECOMMUNICA
878	BE 25	PATIL DHIRAJ SURESH	ELECTRONICS AND TELECOMMUNICA
879	BE 26	/PATIL MAMATA MADHAV	ELECTRONICS AND TELECOMMUNICA
880	BE 27	/PATIL NEHA BABASAHEB	ELECTRONICS AND TELECOMMUNICA
881	BE 28	PATIL POHAN ROHIDAS	ELECTRONICS AND TELECOMMUNICA
882	BE 29	/PATIL SHRADDHA JEEVAN	ELECTRONICS AND TELECOMMUNICA
883	BE 30	PHADNIS CHINMAY AVINASH	ELECTRONICS AND TELECOMMUNICA
884	BE 31	POPAT HARSH GIRISH	ELECTRONICS AND TELECOMMUNICA
885	BE 32	RAM POOJA SUDARSHAN	ELECTRONICS AND TELECOMMUNICA
886	BE 33	/RAUT PRANOTI JAGADISH	ELECTRONICS AND TELECOMMUNICA
887	BE 34	SINGH SANDEEP RADHESHYAM	ELECTRONICS AND TELECOMMUNICA
888	BE 35	SINGH SIKHA DINESH	ELECTRONICS AND TELECOMMUNICA
889	BE 36	TARDE NIKHIL SUNIL	ELECTRONICS AND TELECOMMUNICA
890	BE 37	VARMA SANJAY RAMKUMAR	ELECTRONICS AND TELECOMMUNICA
891	BE 38	VINISH VIJAYAN INDIRA	ELECTRONICS AND TELECOMMUNICA
892	BE 39	YADAV MOHAN RAMNIWAS	ELECTRONICS AND TELECOMMUNICA
893	BE 40	YADAV SHESHINATH RADHASHYAM	ELECTRONICS AND TELECOMMUNICA
894	SEA01	ADATE RAHUL CHANDRAKANT	MECHANICAL ENGINEERING
895	SEA02	ANWARE UBAlDULLAH ABDAS	MECHANICAL ENGINEERING
896	SEA03	ATHAWALE HRISHIKESH SUNIL	MECHANICAL ENGINEERING
897	SEA04	BHOIR SHUBHAM PRAKASH	MECHANICAL ENGINEERING
898	SEA05	BHOSALE MAYURESH DILIP	MECHANICAL ENGINEERING
899	SEA06	CHAVAN PRATIK SUNIL	MECHANICAL ENGINEERING
900	SEA07	CHAVAN SAMBHAJI SHIVAJI	MECHANICAL ENGINEERING
901	SEA08	DABHANE JAGDISH PANDURANG	MECHANICAL ENGINEERING
902	SEA09	DESHMUKH DARSHAN NILKANTHRAO	MECHANICAL ENGINEERING
903	SEA10	DESHPANDE YOGIRAJ MANISH	MECHANICAL ENGINEERING
904	SEA11	DHAMANE DHANANJAY DAGADU	MECHANICAL ENGINEERING
905	SEA12	DOIPHODE AKASH ARJUN	MECHANICAL ENGINEERING
906	SEA13	GAIKAWD CHETAN SAUDAGAR	MECHANICAL ENGINEERING
907	SEA14	GAIKWAD PRATIK PRADIP	MECHANICAL ENGINEERING
908	SEA15	GAIKWAD SAHIL SANJAY	MECHANICAL ENGINEERING
909	SEA16	GAMARE SAURABH SATISH	MECHANICAL ENGINEERING
910	SEA17	GHARAT AARTI VISHWANATH	MECHANICAL ENGINEERING
911	SEA18	GHARAT SARVESH SHIVDAS	MECHANICAL ENGINEERING
912	SEA19	GHARAT UTKARSH DHARMENDRA	MECHANICAL ENGINEERING
913	SEA20	GHOSALKAR PARESH PRAKASH	MECHANICAL ENGINEERING
914	SEA21	GHULE ATUL VILAS	MECHANICAL ENGINEERING
915	SEA22	GORDE PRASHANT DASHARATH	MECHANICAL ENGINEERING
916	SEA23	GUNJAL SARVESH SANTOSH	MECHANICAL ENGINEERING
917	SEA24	GURAV NIKHIL MAHADEV	MECHANICAL ENGINEERING
918	SEA25	GUTTE KRUSHNA VITTHAL	MECHANICAL ENGINEERING



TRUE COPY

JKP

919	SEA26	HULGE ANIKET BAPURAO	MECHANICAL ENGINEERING
920	SEA27	JADHAV DEPESH D.	MECHANICAL ENGINEERING
921	SEA28	JADHAV MAYUR JAGDISH	MECHANICAL ENGINEERING
922	SEA29	KADAM SURAJ SUHAS	MECHANICAL ENGINEERING
923	SEA30	KAMBLE ANIKET BALU	MECHANICAL ENGINEERING
924	SEA31	KAMBLE RUSHIKESH RAMESH	MECHANICAL ENGINEERING
925	SEA32	KHANDEKAR TUSHAR RAJARAM	MECHANICAL ENGINEERING
926	SEA33	KHEDEKAR SHUBHAM RAOSAHEB	MECHANICAL ENGINEERING
927	SEA34	KOLI OMKAR CHANDRAKANT	MECHANICAL ENGINEERING
928	SEA35	KULKARNI SHREERANG PRAMOD	MECHANICAL ENGINEERING
929	SEA36	MAHADIK ANIKET BALIRAM	MECHANICAL ENGINEERING
930	SEA37	MALIEKAL JITHIN JOSE	MECHANICAL ENGINEERING
931	SEA38	MALUSARE SNEHA VIJAY	MECHANICAL ENGINEERING
932	SEA39	MANDARE PRANAY DATTARAM	MECHANICAL ENGINEERING
933	SEA40	MHATRE SNEHAL MADHUKAR	MECHANICAL ENGINEERING
934	SEA41	MAYEKAR PRATIK VITHOBA	MECHANICAL ENGINEERING
935	SEA42	MESTRI PRASAD RAJENDRA	MECHANICAL ENGINEERING
936	SEA43	MHATRE JAYESH DINANATH	MECHANICAL ENGINEERING
937	SEA44	MHATRE RUSHABH BALIRAM	MECHANICAL ENGINEERING
938	SEA45	MHATRE SANKET SUBHASH	MECHANICAL ENGINEERING
939	SEA46	MHATRE SHREYASH KRISHNA	MECHANICAL ENGINEERING
940	SEA47	MHATRE SNEHA BHARAT	MECHANICAL ENGINEERING
941	SEA48	MOHITE AJINKAYA RAMCHANDRA	MECHANICAL ENGINEERING
942	SEA49	MOKAL AMIT VILAS	MECHANICAL ENGINEERING
943	SEA50	MOKAL SAHIL KAMALAKAR	MECHANICAL ENGINEERING
944	SEA51	MONDKAR SANDEEP JAGDISH	MECHANICAL ENGINEERING
945	SEA52	MORE OMKAR GANESH	MECHANICAL ENGINEERING
946	SEA53	NANGARE SHUBHAM RAMDAS	MECHANICAL ENGINEERING
947	SEA54	NIKAM CHAITANYA	MECHANICAL ENGINEERING
948	SEA55	NIVETKAR YASH DINESH	MECHANICAL ENGINEERING
949	SEA56	PABLE SUKHJIT SINGH	MECHANICAL ENGINEERING
950	SEA57	PALASKAR VISHAL AJAY	MECHANICAL ENGINEERING
951	SEA58	PAPAL CHIRAG DILIP	MECHANICAL ENGINEERING
952	SEA59	PATARE SWAPNIL PRAMOD	MECHANICAL ENGINEERING
953	SEA60	PATIL HARISHCHANDRA SURESH	MECHANICAL ENGINEERING
954	SEA61	PATIL SHUBHAM HARISHCHANDRA	MECHANICAL ENGINEERING
955	SEA62	PATIL TANMAY DHANAJI	MECHANICAL ENGINEERING
956	SEA63	PATIL UMESH SHRIKRISHANA	MECHANICAL ENGINEERING
957	SEA64	PAWAR NIKHIL SHIVAJI	MECHANICAL ENGINEERING
958	SEA65	PHADKE ROHIT MAYA	MECHANICAL ENGINEERING
959	SEA66	RAUT ABHIJEET MAHADEV	MECHANICAL ENGINEERING
960	SEA67	SAGWEKAR SHUBHAM VIJAY	MECHANICAL ENGINEERING
961	SEA68	SANE GANESH LAXMAN	MECHANICAL ENGINEERING
962	SEA69	SAWANT BHUSHAN SAMPAT	MECHANICAL ENGINEERING



TRUE COPY

[Signature]
Principal
Vishwaniketan's (I MBET)

963	SEA70	SHELAR ADITYA DATTARAM	MECHANICAL ENGINEERING
964	SEA71	SHINDE PRATHAMESH PRAMOD	MECHANICAL ENGINEERING
965	SEA72	SHIRSAT PRANAL AVADHUT	MECHANICAL ENGINEERING
966	SEA73	SUNKA VIJAY PRABHAKAR	MECHANICAL ENGINEERING
967	SEA74	SUPE LOKESH RAJENDRA	MECHANICAL ENGINEERING
968	SEA75	TEMBARE PRITAM HANUMANT	MECHANICAL ENGINEERING
969	SEA76	THALE SANKET SANTOSH	MECHANICAL ENGINEERING
970	SEA77	THOMBARE SANKET APPA	MECHANICAL ENGINEERING
971	SEA78	UTALE NIKHIL MARUTI	MECHANICAL ENGINEERING
972	SEA79	VAZE PRASHANT CHANDRAKANT	MECHANICAL ENGINEERING
973	SEB01	ACHARYA SRIRAJ RAJENDRAN	MECHANICAL ENGINEERING
974	SEB02	AUTADE VISHWAJEET MADHUKAR	MECHANICAL ENGINEERING
975	SEB03	AWATE SMITESH HANUMANT	MECHANICAL ENGINEERING
976	SEB04	BALMIKI RACHANA SURAJ	MECHANICAL ENGINEERING
977	SEB05	BANGAR VIKAS ARJUN	MECHANICAL ENGINEERING
978	SEB06	BAWASKAR SIMRAN SUNIL	MECHANICAL ENGINEERING
979	SEB07	BHAGAT HARSH MACHINDRA	MECHANICAL ENGINEERING
980	SEB08	BHOSALE OMKAR SHANKAR	MECHANICAL ENGINEERING
981	SEB09	CHALKE DEEPESH	MECHANICAL ENGINEERING
982	SEB10	CHAVAN GANESH BALKRUSHN	MECHANICAL ENGINEERING
983	SEB11	CHOUDHARY VIKRAM KHARTARAM	MECHANICAL ENGINEERING
984	SEB12	DESAI RUSHIKESH RAJENDRA	MECHANICAL ENGINEERING
985	SEB13	DESHMUKH KALPESH SURESH	MECHANICAL ENGINEERING
986	SEB14	DHARANE DIPESH ASHOK ASHWINI	MECHANICAL ENGINEERING
987	SEB15	DHUMAL JAYESH VILAS	MECHANICAL ENGINEERING
988	SEB16	GAJRE ABHISHEK AMRUT	MECHANICAL ENGINEERING
989	SEB17	GAVALI SIDDHESH VIKAS	MECHANICAL ENGINEERING
990	SEB18	GHARAT SAISHWAR SHRIKANT	MECHANICAL ENGINEERING
991	SEB19	GHODE SURAJ NIVRUTTI	MECHANICAL ENGINEERING
992	SEB20	GHORPADE SUBODH V	MECHANICAL ENGINEERING
993	SEB21	GIRI ROHIT P.	MECHANICAL ENGINEERING
994	SEB22	GODSE OMKAR SHAILESH	MECHANICAL ENGINEERING
995	SEB23	GORE ROHIT RANOJI	MECHANICAL ENGINEERING
996	SEB24	GOYAL CHIRAG MADAN	MECHANICAL ENGINEERING
997	SEB25	HAWARE HRUSHIKESH AVINASH	MECHANICAL ENGINEERING
998	SEB26	JANGAM OMKAR VIJAYKUMAR	MECHANICAL ENGINEERING
999	SEB27	KHAIRNAR HARSHAL AMRUT	MECHANICAL ENGINEERING
1000	SEB28	KHEDKAR PRANAL RAJESH	MECHANICAL ENGINEERING
1001	SEB29	KOKANE OMKAR SOMESHWAR	MECHANICAL ENGINEERING
1002	SEB30	KOLI KUNAL YASHWANT	MECHANICAL ENGINEERING
1003	SEB31	KOLI RUSHIKESH GOVIND	MECHANICAL ENGINEERING
1004	SEB32	KONJE KALPESH RAVINDRA	MECHANICAL ENGINEERING
1005	SEB33	MALI RUSHIKESH RAVINDRA	MECHANICAL ENGINEERING
1006	SEB34	MANDHARE PRATIK PRAMOD	MECHANICAL ENGINEERING



TRUE COPY
Principal
Vishwaniketan's (I MEET)

1007	SEB35	MHATRE AADARSH DHARMENDRA	MECHANICAL ENGINEERING
1008	SEB36	MHATRE KARAN MANOJ	MECHANICAL ENGINEERING
1009	SEB37	MHATRE NISHANT RAVINDRA	MECHANICAL ENGINEERING
1010	SEB38	MHATRE VINAY RATNAKAR	MECHANICAL ENGINEERING
1011	SEB39	MOJAR SANKET MAHENDRA SMITA	MECHANICAL ENGINEERING
1012	SEB40	MORE ANISH VIJAY	MECHANICAL ENGINEERING
1013	SEB41	MULAY MAHESH DNYANDEO	MECHANICAL ENGINEERING
1014	SEB42	NAIKWADE MITHLESHA MOTILAL	MECHANICAL ENGINEERING
1015	SEB43	NARAYANKAR NAVIN DATTA	MECHANICAL ENGINEERING
1016	SEB44	OWAL HRUTVIK PANDURANG	MECHANICAL ENGINEERING
1017	SEB45	PAGADE RAJ PADMAKAR	MECHANICAL ENGINEERING
1018	SEB46	PAKHARE ADITYA KISHOR	MECHANICAL ENGINEERING
1019	SEB47	PARDESHI ABHISHEK DILIP	MECHANICAL ENGINEERING
1020	SEB48	PATIL ABHISHEK ANKUSH	MECHANICAL ENGINEERING
1021	SEB49	PATIL AKSHAY NAMDEV	MECHANICAL ENGINEERING
1022	SEB50	PATIL JAYESH VIJAY	MECHANICAL ENGINEERING
1023	SEB51	PATIL PRATHAMESH GANESH	MECHANICAL ENGINEERING
1024	SEB52	PATIL PRATIKSHA KASHINATH	MECHANICAL ENGINEERING
1025	SEB53	PATIL SHUBHAM VIJAYKUMAR	MECHANICAL ENGINEERING
1026	SEB54	PATIL SIDDHESH LAXMAN	MECHANICAL ENGINEERING
1027	SEB55	PAWAR ANIKET BAPU	MECHANICAL ENGINEERING
1028	SEB56	PEDGE JALINDAR SUBHASHRAO	MECHANICAL ENGINEERING
1029	SEB57	RAJGURU PIYUSH RAMESH	MECHANICAL ENGINEERING
1030	SEB58	RAMDHARNE MANISH ARUN	MECHANICAL ENGINEERING
1031	SEB59	RANE RUSHIKESH RAJENDRA	MECHANICAL ENGINEERING
1032	SEB60	RAUT RUSHIKESH SUNIL	MECHANICAL ENGINEERING
1033	SEB61	RAUT TABISH ISMAIL	MECHANICAL ENGINEERING
1034	SEB62	SALUNKHE ANKUR JANARDAN	MECHANICAL ENGINEERING
1035	SEB63	SASTE VIKIN GANGARAM	MECHANICAL ENGINEERING
1036	SEB64	SHEJALE SHUBHAM RAJESH	MECHANICAL ENGINEERING
1037	SEB65	SHINDE MAYUR DATTA	MECHANICAL ENGINEERING
1038	SEB66	SHINDE SAHIL RAJENDRA	MECHANICAL ENGINEERING
1039	SEB67	SHINDE YASH DEEPAK	MECHANICAL ENGINEERING
1040	SEB68	SHUKLA ABHISHEK DINESHKUMAR	MECHANICAL ENGINEERING
1041	SEB69	SINGH AAKASH DEVENDAR	MECHANICAL ENGINEERING
1042	SEB70	SINGH ABHISHEK KUNWAR SAROJ	MECHANICAL ENGINEERING
1043	SEB71	SONAWANE VEDANT SANJAY	MECHANICAL ENGINEERING
1044	SEB72	SURYAWANSHI NIKHIL SUNIL	MECHANICAL ENGINEERING
1045	SEB73	THAKUR BHUVANESH SANJAY	MECHANICAL ENGINEERING
1046	SEB74	TIWARE PRANAY RAJENDRA	MECHANICAL ENGINEERING
1047	SEB75	UMBARKAR AJAY VITTHAL	MECHANICAL ENGINEERING
1048	SEB76	UTEKAR NIKHIL S	MECHANICAL ENGINEERING
1049	SEB77	VEDAK HARSH AKASHNAND	MECHANICAL ENGINEERING
1050	SEB78	VHORE SHYAMSUNDAR KESHAV	MECHANICAL ENGINEERING

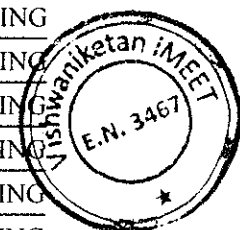

TRUE COPY

Principal
Vishwaniketan's (I MBET)

1051	SEB79	VISHWAKARMA SHIVAM SHRIRAM	MECHANICAL ENGINEERING
1052	TEA01	AMBURLE SWAPNIL RAJEEV SUNITA	MECHANICAL ENGINEERING
1053	TEA02	ARKE SAGAR BHAUSAHEB REKHA	MECHANICAL ENGINEERING
1054	TEA03	BADGUJAR TUSHAR BHAI CHANDRA VAISHI	MECHANICAL ENGINEERING
1055	TEA04	BANGAR SAURABH SHIVAJI	MECHANICAL ENGINEERING
1056	TEA05	BARSHI ASHISH NARAYAN SUJATA	MECHANICAL ENGINEERING
1057	TEA06	AGIWALE NIKET DATTARAM	MECHANICAL ENGINEERING
1058	TEA07	CHOUGALE SAMYANTAK SANJAY SANGEET	MECHANICAL ENGINEERING
1059	TEA08	DALVI OMKAR PRAMOD PRANALI	MECHANICAL ENGINEERING
1060	TEA09	DAWARE VAIBHAV PRAKASH PRAMILA	MECHANICAL ENGINEERING
1061	TEA10	DESHMUKH RATNADEEP RAMCHANDRA RO	MECHANICAL ENGINEERING
1062	TEA11	DHAYAL SHREEKUMAR RATANLAL SAJJAN	MECHANICAL ENGINEERING
1063	TEA12	DHOPTA VIDYADHAR ARUNKUMAR SEEMA	MECHANICAL ENGINEERING
1064	TEA13	GAIKAR SUMEET MANOHAR	MECHANICAL ENGINEERING
1065	TEA14	GAIKWAD ANIRUDDHA SUDHIR ARADHANA	MECHANICAL ENGINEERING
1066	TEA15	GAJARE ROHAN LAXMAN SANGITA	MECHANICAL ENGINEERING
1067	TEA16	GHATTARGI GAURINANDAN LAXMAN PUSHI	MECHANICAL ENGINEERING
1068	TEA17	GHEVDE SAURABH	MECHANICAL ENGINEERING
1069	TEA18	GHOSALKAR GAURAV GURUDATTA	MECHANICAL ENGINEERING
1070	TEA19	CHAVAN SURAJ SHANTARAM	MECHANICAL ENGINEERING
1071	TEA20	DHURE SAURABH VISHNU	MECHANICAL ENGINEERING
1072	TEA21	GAIKAR RAKESH RAMESH	MECHANICAL ENGINEERING
1073	TEA22	HADAWALE PRATIK KUSHABHAU	MECHANICAL ENGINEERING
1074	TEA23	HEGDE SUMANTH SURESH VILASINI	MECHANICAL ENGINEERING
1075	TEA24	GAWALI VILAS ARJUN	MECHANICAL ENGINEERING
1076	TEA25	JAGDALE ADITYA AJAYKUMAR ADITI	MECHANICAL ENGINEERING
1077	TEA26	JANGAM ANIKET SUHAS ANJANA	MECHANICAL ENGINEERING
1078	TEA27	JATKAR AYYAZ HUSSAIN AHISHA	MECHANICAL ENGINEERING
1079	TEA28	JUIKAR KARANRAJ PRAVIN	MECHANICAL ENGINEERING
1080	TEA29	KAMBLE PRANIL DNYANESHWAR SHEETAL	MECHANICAL ENGINEERING
1081	TEA30	KHANDAKALE KUNDAN RAMESH GEETA	MECHANICAL ENGINEERING
1082	TEA31	BORLE VIRAJ RAMDAS	MECHANICAL ENGINEERING
1083	TEA32	KHOT RUSHIKESH HANAMANT BHARATI	MECHANICAL ENGINEERING
1084	TEA33	MALI SHUBHAM RAMCHANDRA LATA	MECHANICAL ENGINEERING
1085	TEA34	ITHAPE TUSHAR VITTHAL	MECHANICAL ENGINEERING
1086	TEA35	MHATRE SANMIT SANTOSH SWATI	MECHANICAL ENGINEERING
1087	TEA36	JAUNJAL NAGESH PRADEEP	MECHANICAL ENGINEERING
1088	TEA37	PANDHARE AKSHAY MADHUKAR UJAWALA	MECHANICAL ENGINEERING
1089	TEA38	PANGRE MOHAN JAYANTA	MECHANICAL ENGINEERING
1090	TEA39	PATIL AKSHAY ATUL APARNA	MECHANICAL ENGINEERING
1091	TEA40	PATIL ANIKET	MECHANICAL ENGINEERING
1092	TEA41	PATIL KALPESH RAMESH	MECHANICAL ENGINEERING
1093	TEA42	PATIL OMKAR ULHAS NEETA	MECHANICAL ENGINEERING
1094	TEA43	PATIL RAKESH RAMCHANDRA VANITA	MECHANICAL ENGINEERING



TRUE COPY

J.P.P.

Principal
Vishwaniketan's (iMEET)

1095	TEA44	PATIL SANKET RAMESH UTTARA	MECHANICAL ENGINEERING
1096	TEA45	PATIL SHANTANU NITIN MANJUSHA	MECHANICAL ENGINEERING
1097	TEA46	MEKALE SACHIN SANJAY	MECHANICAL ENGINEERING
1098	TEA47	PAWADE PRIYANKA	MECHANICAL ENGINEERING
1099	TEA48	PAWAR PRIYANKA VIJAY AARTI	MECHANICAL ENGINEERING
1100	TEA49	PAWAR SURAJ DILIP RESHMA	MECHANICAL ENGINEERING
1101	TEA50	PHADTARE SANKET SANJAY NANDA	MECHANICAL ENGINEERING
1102	TEA51	RANANAVARE OMKAR GOPAL KESHAR	MECHANICAL ENGINEERING
1103	TEA52	MHATRE AKSHAY NAMDEO	MECHANICAL ENGINEERING
1104	TEA53	SALE SWAPNIL SANJAY ANJALI	MECHANICAL ENGINEERING
1105	TEA54	SALVI RUSHIKESH MAHENDRA MOHINI	MECHANICAL ENGINEERING
1106	TEA55	SAPRE MAYURESH MAHENDRA KALYANI	MECHANICAL ENGINEERING
1107	TEA56	SARNAIK SUSHIL HINDURAO	MECHANICAL ENGINEERING
1108	TEA57	SINGH KARANPREET RAJINDERSINGH HARJ	MECHANICAL ENGINEERING
1109	TEA58	SUGANDHI RAJEEV KISHORE RICHA	MECHANICAL ENGINEERING
1110	TEA59	THAKUR RUSHIKESH RAMESH	MECHANICAL ENGINEERING
1111	TEA60	GAIKWAD SANGRAM SHIVAJI	MECHANICAL ENGINEERING
1112	TEA61	THALE PRIYAJ PRAKASH LALITA	MECHANICAL ENGINEERING
1113	TEA62	VEER TUSHAR CHANGDEO SUVARNA	MECHANICAL ENGINEERING
1114	TEA63	VISHWAKARMA SACHHIDANAND RAMHARS	MECHANICAL ENGINEERING
1115	TEA64	WANI NAYAN RAJENDRA SARITA	MECHANICAL ENGINEERING
1116	TEA65	WARDE SACHIN SHANTARAM ANITA	MECHANICAL ENGINEERING
1117	TEA66	WARE VISHAL MAHADEV NANDA	MECHANICAL ENGINEERING
1118	TEA67	YADAV SUDHIRKUMAR RAMSHARAN	MECHANICAL ENGINEERING
1119	TEA68	NEVAREKAR NIMISH HEMKANT	MECHANICAL ENGINEERING
1120	TEA69	PATIL OMKAR BHASKAR	MECHANICAL ENGINEERING
1121	TEA70	PATIL SONALI EKANATH	MECHANICAL ENGINEERING
1122	TEA71	RASAL TEJESH SATISH	MECHANICAL ENGINEERING
1123	TEA72	SALVE SAMEER DATTA	MECHANICAL ENGINEERING
1124	TEA73	SANAP PARMESHWAR SUKDEV	MECHANICAL ENGINEERING
1125	TEA74	SAYYED KAMRAN ASIF	MECHANICAL ENGINEERING
1126	TEA75	THAKUR DILIP KISHOR	MECHANICAL ENGINEERING
1127	TEA76	THAKUR SIDDHESH JANARDHAN	MECHANICAL ENGINEERING
1128	TEA77	VIDHATE HIMALAY JAYANT	MECHANICAL ENGINEERING
1129	TEA78	LOKHANDE DHANANJAY DEVIDAS	MECHANICAL ENGINEERING
1130	TEB01	AJAGEKAR PRATIK ANANDA SANGITA	MECHANICAL ENGINEERING
1131	TEB02	AUTI VISHAL JALINDAR SUNITA	MECHANICAL ENGINEERING
1132	TEB03	AMBATE SACHINREDDI NARSAREDDI	MECHANICAL ENGINEERING
1133	TEB04	BHOSALE VIPUL SANJAY SANGEETA	MECHANICAL ENGINEERING
1134	TEB05	CHAVAN SAURABH SURESH BHARATI	MECHANICAL ENGINEERING
1135	TEB06	CHOUDHARY RAKESH BHAWARLAL VIPLA	MECHANICAL ENGINEERING
1136	TEB07	DHUMAL SAURABH NAMDEV NILIMA	MECHANICAL ENGINEERING
1137	TEB08	DWIVEDI KARAN RAJENDRA RAMSAKHII	MECHANICAL ENGINEERING
1138	TEB09	UGALMUGALE SANTOSH PANDURANG	MECHANICAL ENGINEERING



TRUE COPY

[Signature]

Principal

Vishwaniketan's (iMEET)

1139	TEB10	BHAVSAR VEDANT UMESH	MECHANICAL ENGINEERING
1140	TEB11	GUNJAL AKSHAY	MECHANICAL ENGINEERING
1141	TEB12	JADHAV ABHISHEK GANPAT SUSHAMA	MECHANICAL ENGINEERING
1142	TEB13	JADHAV ASHOK GANGADHAR MANISHA	MECHANICAL ENGINEERING
1143	TEB14	JADHAV NIKHIL RAJENDRA SHOBHA	MECHANICAL ENGINEERING
1144	TEB15	JAMBHALE MAYUR NATHURAM NANDA	MECHANICAL ENGINEERING
1145	TEB16	JAMBHALIKAR ATUL ASHOK PRATIBHA	MECHANICAL ENGINEERING
1146	TEB17	JUIKAR MITESH JANARDAN SANGITA	MECHANICAL ENGINEERING
1147	TEB18	KARANDE TEJAS DAJI MANISHA	MECHANICAL ENGINEERING
1148	TEB19	CHALVADI VIVEK VANRAJ	MECHANICAL ENGINEERING
1149	TEB20	CHAUDHARI HARSHAL RAJENDRA	MECHANICAL ENGINEERING
1150	TEB21	CHIRNERKAR ABHIJIT NANDKUMAR	MECHANICAL ENGINEERING
1151	TEB22	KUTE SHUBHAM SADANAND UJWALA	MECHANICAL ENGINEERING
1152	TEB23	GAIKAR AKSHAY YASHWANT	MECHANICAL ENGINEERING
1153	TEB24	MHATRE JAYESH VISHWANATH SHUBHANG	MECHANICAL ENGINEERING
1154	TEB25	MHATRE PRATIK DATTARAM PRIYA	MECHANICAL ENGINEERING
1155	TEB26	MHATRE PRATIK PRAKASH ANJANI	MECHANICAL ENGINEERING
1156	TEB27	VALIMBE KAMALAKAR MORESHWAR	MECHANICAL ENGINEERING
1157	TEB28	GORAD VISHAL BHIMRAO	MECHANICAL ENGINEERING
1158	TEB29	JADHAV AVINASH BALKRISHNA	MECHANICAL ENGINEERING
1159	TEB30	JADHAV NILESH RAJARAM	MECHANICAL ENGINEERING
1160	TEB31	JAGTAP ABHISHEK DADASAHEB	MECHANICAL ENGINEERING
1161	TEB32	NAIK SHUBHANKAR PRAVIN SHACHI	MECHANICAL ENGINEERING
1162	TEB33	NALAWADE AKSHAY KISAN	MECHANICAL ENGINEERING
1163	TEB34	KHARAT AKSHAY ANNA	MECHANICAL ENGINEERING
1164	TEB35	PAGAR SHANTANU VIJAY ANITA	MECHANICAL ENGINEERING
1165	TEB36	LAD SANDESH VILAS	MECHANICAL ENGINEERING
1166	TEB37	PATIL PRANIT NARAYAN GULAB	MECHANICAL ENGINEERING
1167	TEB38	PATIL SARVESH SURESH SARITA	MECHANICAL ENGINEERING
1168	TEB39	MOHAPE PRAJYOT HANUMANT	MECHANICAL ENGINEERING
1169	TEB40	POWAR TUSHAR SHRIPATI MANGAL	MECHANICAL ENGINEERING
1170	TEB41	PRAJAPATI RAMBABU DAYASHANKAR	MECHANICAL ENGINEERING
1171	TEB42	KHATALE DEEPAK BABLING	MECHANICAL ENGINEERING
1172	TEB43	PATIL BHAVESH NARDAS	MECHANICAL ENGINEERING
1173	TEB44	PATIL DIVYANK NANDAKUMAR	MECHANICAL ENGINEERING
1174	TEB45	SALUNKE HRUSHIKESH BHARATBHUSHAN	MECHANICAL ENGINEERING
1175	TEB46	PAWAR ROHAN SANTOSH	MECHANICAL ENGINEERING
1176	TEB47	SAMSON STEPHION	MECHANICAL ENGINEERING
1177	TEB48	SARUK RAHUL SHESHERAO RADHABAI	MECHANICAL ENGINEERING
1178	TEB49	SHAIKH SAHEB MOIN RESHMA	MECHANICAL ENGINEERING
1179	TEB50	SHINDE GANESH RAMCHANDRA MANISHA	MECHANICAL ENGINEERING
1180	TEB51	SHIROLE SAGAR SHAHAJI SUJATA	MECHANICAL ENGINEERING
1181	TEB52	SHIVTHARE ABHISHEK ROHIDAS RUPALI	MECHANICAL ENGINEERING
1182	TEB53	SINGH CHANDAN SHAMBHU PRAMILA	MECHANICAL ENGINEERING

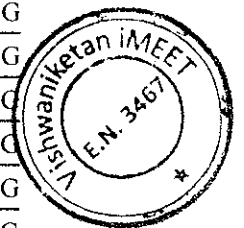

TRIAL COPY

[Signature]
Principal
Vishwaniketan's (iMEET)

1183	TEB54	SOLSE AJAY ROHIDAS SUNITA	MECHANICAL ENGINEERING
1184	TEB55	SONAWALE SUYOG DATTATRAY SUVARNA	MECHANICAL ENGINEERING
1185	TEB56	SURVE DHIRAJ SHRIRANG SAVITA	MECHANICAL ENGINEERING
1186	TEB57	SURVE SHIVAM RAJESH RUPESHA	MECHANICAL ENGINEERING
1187	TEB58	THAKUR ABHIJEET SHRIKANT AMITA	MECHANICAL ENGINEERING
1188	TEB59	THAKUR SUYOG GANGADHAR	MECHANICAL ENGINEERING
1189	TEB60	SHEMBADE AKSHAYKUMAR MARUTI	MECHANICAL ENGINEERING
1190	TEB61	SHEET HARSHAL CHANDRAKANT	MECHANICAL ENGINEERING
1191	TEB62	RATHOD MAHESH RAM	MECHANICAL ENGINEERING
1192	TEB63	PARINGE SHRIKANT MARUTI	MECHANICAL ENGINEERING
1193	TEB64	VAISHAMPAYAN HRISHI SHRIKANT	MECHANICAL ENGINEERING
1194	TEB65	UPASE SWAPNIL VAIJANATH	MECHANICAL ENGINEERING
1195	TEB66	BHANGE HITESH RAMDAS	MECHANICAL ENGINEERING
1196	TEB67	GAIKWAD JONATHAN	MECHANICAL ENGINEERING
1197	TEB68	JAGDALE AKSHAY VILAS	MECHANICAL ENGINEERING
1198	TEB69	CHOUGULE AKSHAY BAPURRAO	MECHANICAL ENGINEERING
1199	TEB70	KOLEKAR AVINASH B.	MECHANICAL ENGINEERING
1200	TEB71	PATIL RUSHIKESH V.	MECHANICAL ENGINEERING
1201	TEB72	MANDHARE DEEPAK	MECHANICAL ENGINEERING
1202	TEB73	TARADE MAYUR ASHOK	MECHANICAL ENGINEERING
1203	TEB74	AHIRE AKSHAY DILIP	MECHANICAL ENGINEERING
1204	TEB75	ANIRUDDHA RADHAKRISHNAN	MECHANICAL ENGINEERING
1205	TEB76	RAHUL SINGH	MECHANICAL ENGINEERING
1206	TEB77	NADAR RENJITH RAGHU	MECHANICAL ENGINEERING
1207	TEB78	VIMLESH YADAV	MECHANICAL ENGINEERING
1208	BE A01	ADSULE SUVARNA DHYANESHWAR	MECHANICAL ENGINEERING
1209	BE A02	AROTE PARESH BABAN SANGITA	MECHANICAL ENGINEERING
1210	BE A03	BAGAL AKSHAY MOHAN MANISHA	MECHANICAL ENGINEERING
1211	BE A04	BAMANKAR MANJUSH PRAVIN	MECHANICAL ENGINEERING
1212	BE A05	BHAGAT NIKHIL SANJAY MEGHA	MECHANICAL ENGINEERING
1213	BE A06	BHOSALE ABHISHEK SHIVAJI SANGEETA	MECHANICAL ENGINEERING
1214	BE A07	BORHADE HARSHAD DASHRATH	MECHANICAL ENGINEERING
1215	BE A08	CHALKE RACHANA DINESH MUKTA	MECHANICAL ENGINEERING
1216	BE A09	CHAUHAN DHIRAJ SARVJEET REETA	MECHANICAL ENGINEERING
1217	BE A10	CHAVARKAR PALASH MILIND MILIKA	MECHANICAL ENGINEERING
1218	BE A11	CHOUDHARY RAMESH DINESH KAMALA	MECHANICAL ENGINEERING
1219	BE A12	CHOUGLE SUHAIL MOHAMMED SHAFI	MECHANICAL ENGINEERING
1220	BE A13	DANGAR RUNIT RAVINDRA RAVINA	MECHANICAL ENGINEERING
1221	BE A14	DHANSE MUZAMMIL MOHAMMAD RAFIQUE	MECHANICAL ENGINEERING
1222	BE A15	DOKE SANDESH SUKHDEV VANDANA	MECHANICAL ENGINEERING
1223	BE A16	ERANDE SHUBHAM SANJAY VIMAL	MECHANICAL ENGINEERING
1224	BE A17	FANASKAR TABISH ANIS RASHIDA	MECHANICAL ENGINEERING
1225	BE A18	GAIKWAD KUNAL HEMANT SANDHYA	MECHANICAL ENGINEERING
1226	BE A19	GOLAM PRADIP PRAKASH PRAMILA	MECHANICAL ENGINEERING

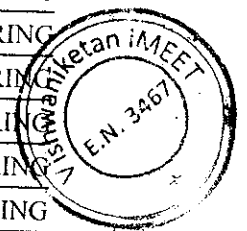

TRUE COPY

Principal
Vishwanath's (I) MEET

1227	BE A20	GORULE PRANAV SHIVAJI SARITA	MECHANICAL ENGINEERING
1228	BE A21	GUNAGI NIKHIL BALKRISHNA MANISHA	MECHANICAL ENGINEERING
1229	BE A22	HATAGADE PRIYANKA VINAYAK	MECHANICAL ENGINEERING
1230	BE A23	JADHAV SAHIL GHANSHYAM PRAFULLATA	MECHANICAL ENGINEERING
1231	BE A24	JAMBHALE HITESH ANIL UJWALA	MECHANICAL ENGINEERING
1232	BE A25	JORI VISHAL MACHHINDRA INDU	MECHANICAL ENGINEERING
1233	BE A26	JORWEKAR AKSHAY ASHOK SMITHA	MECHANICAL ENGINEERING
1234	BE A27	KAKADE SHUBHAM ANIL JYOTI	MECHANICAL ENGINEERING
1235	BE A28	KALE HEMANTKUMAR GANESH SHARDA	MECHANICAL ENGINEERING
1236	BE A29	KANGE PRITI PANDHRINATH CHHAYA	MECHANICAL ENGINEERING
1237	BE A30	KHARAT PRATHAMESH BALKRISHNA LATA	MECHANICAL ENGINEERING
1238	BE A31	KHEDEKAR PRATHAMESH CHANDRKANT	MECHANICAL ENGINEERING
1239	BE A32	KOTIAN TEJAS RAVINDRANATH	MECHANICAL ENGINEERING
1240	BE A33	KULKARNI NITIN NAGESH NANDA	MECHANICAL ENGINEERING
1241	BE A34	LALGE VAIBHAV GAJENDRA SHARADA	MECHANICAL ENGINEERING
1242	BE A35	LOMTE VISHAL PANDURANG SUNITA	MECHANICAL ENGINEERING
1243	BE A36	MAHADIK SUKALP DEEPAK RUCHIRA	MECHANICAL ENGINEERING
1244	BE A37	MANDE POONAM KAMALAKAR ASHVINI	MECHANICAL ENGINEERING
1245	BE A38	MHATRE ABHISHEK JANARDAN	MECHANICAL ENGINEERING
1246	BE A39	MHATRE J. GAURAV	MECHANICAL ENGINEERING
1247	BE A40	MOHITE SHRIPAD SHRIKANT SHOBHA	MECHANICAL ENGINEERING
1248	BE A41	MORE ANIKET BHAGWAN JAYASHRI	MECHANICAL ENGINEERING
1249	BE A42	MORE YOGESH BALKRISHNA VIMAL	MECHANICAL ENGINEERING
1250	BE A43	NARUTE VAIBHAV RAMDAS	MECHANICAL ENGINEERING
1251	BE A44	NAVIK KANHAIYA LUTTUR SHANTIDEVI	MECHANICAL ENGINEERING
1252	BE A45	NEMANE SHUBHAM SANJAY JAYASHREE	MECHANICAL ENGINEERING
1253	BE A46	PANDIT SIDDHESH GURUNATH SNEHAL	MECHANICAL ENGINEERING
1254	BE A47	PATEKAR ANIKET ABHIMAN MEENA	MECHANICAL ENGINEERING
1255	BE A48	PATHARE MALHAR MAHENDRA MANJULLA	MECHANICAL ENGINEERING
1256	BE A49	PATIL AADESH JAGADISH SHOBHANA	MECHANICAL ENGINEERING
1257	BE A50	PATIL NITIN KAMILAKAR	MECHANICAL ENGINEERING
1258	BE A51	PATIL PRANIT VINIT VIDYA	MECHANICAL ENGINEERING
1259	BE A52	PATIL SARVESH VIKAS PRATIBHA	MECHANICAL ENGINEERING
1260	BE A53	PATIL VIRAJ MOTIRAM SHAILA	MECHANICAL ENGINEERING
1261	BE A54	PISAL YUVRAJ SHIVAJIRAO VANDANA	MECHANICAL ENGINEERING
1262	BE A55	RAI SHIVAM	MECHANICAL ENGINEERING
1263	BE A56	RAJBHAR RAHUL BANSHURAM SUGANA	MECHANICAL ENGINEERING
1264	BE A57	RAJPUT SONU BHARATSINGH SUNITA	MECHANICAL ENGINEERING
1265	BE A58	RANSING ABHIJEET VIJAY SHUBHANGI	MECHANICAL ENGINEERING
1266	BE A59	RUPNAR SAGAR TUKARAM VAISHALI	MECHANICAL ENGINEERING
1267	BE A60	SAWANT NIKHIL JANARDN SHUBHANGI	MECHANICAL ENGINEERING
1268	BE A61	SHINDE PRADIP SUBHASH RANJANA	MECHANICAL ENGINEERING
1269	BE A62	SINGH PREMKUMAR RAMPRATAP	MECHANICAL ENGINEERING
1270	BE A63	SONI PRASHANT DUDHANT	MECHANICAL ENGINEERING

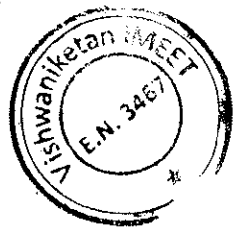

TRUE COPY

[Signature]
Principal
Vishwaniketan's (I MBET)

1271	BE A64	SURYAWANSHI AKSHAYKUMAR LAXMAN S	MECHANICAL ENGINEERING
1272	BE A65	TAMBRE YOGESHWAR RAJESH VIJAYA	MECHANICAL ENGINEERING
1273	BE A66	TEMGHARE SHUBHAM NARAYAN	MECHANICAL ENGINEERING
1274	BE A67	WAGH NIKHIL DADAJI VIDYA	MECHANICAL ENGINEERING
1275	BE A68	WAGHARE SHIVAM SUNIL VIDYA	MECHANICAL ENGINEERING
1276	BE A69	YADAV ABHISHEK MAHESH MAYURI	MECHANICAL ENGINEERING
1277	BE A70	YADAV AJAY HARERAM SUBHAVATI	MECHANICAL ENGINEERING
1278	BE A71	YADAV MUKESH R.	MECHANICAL ENGINEERING
1279	BE A72	YADAV RAKESH MUNNALAL KALAVATI	MECHANICAL ENGINEERING
1280	BE A73	YADAV ROHAN SUDHAKAR NANDA	MECHANICAL ENGINEERING
1281	BE B01	AMALE AKSHAY SURESH	MECHANICAL ENGINEERING
1282	BE B02	ANSARI M. DANISH NOORULAMIN	MECHANICAL ENGINEERING
1283	BE B03	BAGAL MAHESH NAMDEO ASHA	MECHANICAL ENGINEERING
1284	BE B04	BANDAL VISHAL PRAKASH	MECHANICAL ENGINEERING
1285	BE B05	BHAGAT TUSHAR MADHUKAR	MECHANICAL ENGINEERING
1286	BE B06	BHANDARI AKASH HARENDER ASHA	MECHANICAL ENGINEERING
1287	BE B07	BHARATI NANDAN LALLAN MEERA	MECHANICAL ENGINEERING
1288	BE B08	BHOIR MONISH BHAGURAM	MECHANICAL ENGINEERING
1289	BE B09	CHAKRAVORTY RAJDEEP	MECHANICAL ENGINEERING
1290	BE B10	CHOUDHARI AKSHAY PRAKASH	MECHANICAL ENGINEERING
1291	BE B11	DHANGAR PRATHAMESH	MECHANICAL ENGINEERING
1292	BE B12	DHUMAL DHANANJAY	MECHANICAL ENGINEERING
1293	BE B13	DUMBRE SAURABH TUKARAM	MECHANICAL ENGINEERING
1294	BE B14	GHOSALKAR SAHIL	MECHANICAL ENGINEERING
1295	BE B15	GUNJAL GANESH KAILAS SANGITA	MECHANICAL ENGINEERING
1296	BE B16	GUPTA KRISHNA RAJENDRA GEETA	MECHANICAL ENGINEERING
1297	BE B17	HALPATRAO DARSHAN	MECHANICAL ENGINEERING
1298	BE B18	JAGDALE AMIT MOHAN SUVARNA	MECHANICAL ENGINEERING
1299	BE B19	JAGTAP PRANIT VIJAY SHOBHA	MECHANICAL ENGINEERING
1300	BE B20	JAISWAL ARUNKUMAR SHYAMDHANI	MECHANICAL ENGINEERING
1301	BE B21	JILANI SHAHID MUKHTAR RUBEENA	MECHANICAL ENGINEERING
1302	BE B22	KADAM ABHISHEK KRISHNAT CHANDNA	MECHANICAL ENGINEERING
1303	BE B23	KADAM ASHISH SAYAJIRAO JAYASHREE	MECHANICAL ENGINEERING
1304	BE B24	KHARIVALE NIKESH BALIRAM PRAMILA	MECHANICAL ENGINEERING
1305	BE B25	KHARIVALE RUPESH DATTATRAY	MECHANICAL ENGINEERING
1306	BE B26	KONDASKAR MANISH PRAMOD SWATI	MECHANICAL ENGINEERING
1307	BE B27	KORI SURAJ RAMMILAN SITA	MECHANICAL ENGINEERING
1308	BE B28	MAHANGARE ABHILASHA LAXMAN	MECHANICAL ENGINEERING
1309	BE B29	MATHE OMKAR SUBHASH ARUNA	MECHANICAL ENGINEERING
1310	BE B30	MHATRE DHANANJAYRAO MACHHINDRAN	MECHANICAL ENGINEERING
1311	BE B31	MHATRE KRUSHIK KESRINATH	MECHANICAL ENGINEERING
1312	BE B32	MHATRE NITIN BHAGAVAN VANDANA	MECHANICAL ENGINEERING
1313	BE B33	MHATRE RUSHIKESH VISHWANATH	MECHANICAL ENGINEERING
1314	BE B34	MISHRA ADARSH RAJESH ARCHANA	MECHANICAL ENGINEERING

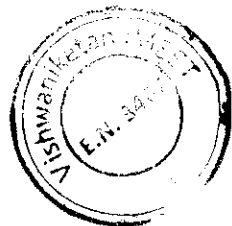

TRUE COPY
[Signature]
Principal
Vishwaniketan's (I MBET)

1315	BE B35	MORE ATUL BABAJI CHANDRABHAGA	MECHANICAL ENGINEERING
1316	BE B36	MORE VISHWAJEET NAVALKUMAR	MECHANICAL ENGINEERING
1317	BE B37	MUNDHE PRAVIN RAMCHANDRA MANIK	MECHANICAL ENGINEERING
1318	BE B38	NAKHAWA SHREYASH SHRIKANT	MECHANICAL ENGINEERING
1319	BE B39	NIKAM GANESH SITARAM	MECHANICAL ENGINEERING
1320	BE B40	PANCHAL ADITYA	MECHANICAL ENGINEERING
1321	BE B41	PANDEY SAKSHAM JAIPRAKASH KAILASH	MECHANICAL ENGINEERING
1322	BE B42	PANMAND AJAY A.	MECHANICAL ENGINEERING
1323	BE B43	PATHAK ANISH ATUL YOGITA	MECHANICAL ENGINEERING
1324	BE B44	PATHAK HIMANSHU RAJESH ARCHANA	MECHANICAL ENGINEERING
1325	BE B45	PATIL ADITYA DNYANESHWAR PRATIBHA	MECHANICAL ENGINEERING
1326	BE B46	PATIL DHANRAJ DEVIDAS DIPALI	MECHANICAL ENGINEERING
1327	BE B47	PATIL JAYESH PANDHARINATH	MECHANICAL ENGINEERING
1328	BE B48	PATIL NIKHIL NARAYAN	MECHANICAL ENGINEERING
1329	BE B49	PATIL PRASAD LAXMAN MADHURI	MECHANICAL ENGINEERING
1330	BE B50	PAWAR AKSHAY AKARAM SEEMA	MECHANICAL ENGINEERING
1331	BE B51	PAWAR ROHAN	MECHANICAL ENGINEERING
1332	BE B52	RATHOD RAHUL MARUTI LATA	MECHANICAL ENGINEERING
1333	BE B53	RATHOUR VIJAY KHEMRAJ PARVATI	MECHANICAL ENGINEERING
1334	BE B54	RAUT SUMIT TANAJI NEETA	MECHANICAL ENGINEERING
1335	BE B55	SAHU SHRIDHAR BANSIDHAR RITA	MECHANICAL ENGINEERING
1336	BE B56	SATANE PRAFULLA BALARAM MANISHA	MECHANICAL ENGINEERING
1337	BE B57	SAYYAD JAVED NABISAHAB NAJAMUN	MECHANICAL ENGINEERING
1338	BE B58	SHAHANE AAKASH GANESH GEETA	MECHANICAL ENGINEERING
1339	BE B59	SHAIKH MUDASSIR BASHIR AYESHA	MECHANICAL ENGINEERING
1340	BE B60	SHEDGE ADITYA HEMANT	MECHANICAL ENGINEERING
1341	BE B61	SONI VISHALKUMAR RAMESHKUMAR	MECHANICAL ENGINEERING
1342	BE B62	SURYAVANSHI OMKAR MANOJ REKHA	MECHANICAL ENGINEERING
1343	BE B63	SYED ARMAAN ABRAR GAZALA	MECHANICAL ENGINEERING
1344	BE B64	TAWADE SHIVTEJ MOHAN MEGHA	MECHANICAL ENGINEERING
1345	BE B65	THAKUR SUJIT TILAKRAJ BABITA	MECHANICAL ENGINEERING
1346	BE B66	THAKUR TRUSHANK KRISHNA	MECHANICAL ENGINEERING
1347	BE B67	THORAT SHUBHAM SHIVAJI VANITA	MECHANICAL ENGINEERING
1348	BE B68	THOSAR PANKAJ TANAJI NALINI	MECHANICAL ENGINEERING
1349	BE B69	UDUGADE VIJAY TANAJI SUVARNA	MECHANICAL ENGINEERING
1350	BE B70	WADE SANJAY R	MECHANICAL ENGINEERING
1351	BE B71	WADKAR VIVEK NAMDEO ASHA	MECHANICAL ENGINEERING
1352	BE B72	YADAV AAKASH YASHWANATA	MECHANICAL ENGINEERING



TRUE COPY

[Signature]
Principal
Vishwaniketan's (I) MEET



VISHWANIKETAN

VISHWANIKETAN

Institute of Management Entrepreneurship and Engineering Technology

Survey No-52 Off Mumbai-Pune Expressway Kumbhivali,

Tal- Khalapur, Maharashtra 410203.

Phone: (02192) 274206/274207/274208/274210

2018-2019

Sr. No.	Roll No.	Name of Student	Name of Program
1	SEA01	ACHARYA VARUN GANPAT	CIVIL ENGINEERING
2	SEA02	BELOTE VISHAL PAPPU	CIVIL ENGINEERING
3	SEA03	BHAGAT DHAVAL DINESH	CIVIL ENGINEERING
4	SEA04	BHAGAT SARVESH JAGDISH	CIVIL ENGINEERING
5	SEA05	BHAT WASEEM	CIVIL ENGINEERING
6	SEA06	BHORING SAGAR MANUBHAI	CIVIL ENGINEERING
7	SEA07	BHUBAL MEGHA DINKAR	CIVIL ENGINEERING
8	SEA08	BUGADE SACHIN TANAJI	CIVIL ENGINEERING
9	SEA09	CHAUDHARY SHEFAI HEMANT	CIVIL ENGINEERING
10	SEA10	CHAVHAN SWARAJ VISHWAS	CIVIL ENGINEERING
11	SEA11	CHOUDHARI DARSHAN ANIL	CIVIL ENGINEERING
12	SEA12	DAMARE RITESH TANAJI	CIVIL ENGINEERING
13	SEA13	DAYANAND SUBHASH INDUBAI	CIVIL ENGINEERING
14	SEA14	DESHMUKH PRATHMESH NARESH	CIVIL ENGINEERING
15	SEA15	DESHMUKH ANKITA VIKAS	CIVIL ENGINEERING
16	SEA16	DESHMUKH SHUBHAM SANJAY	CIVIL ENGINEERING
17	SEA17	DHAWALE GITANJLI GOVIND	CIVIL ENGINEERING
18	SEA18	DHEMBRE PRATHMESH APPASAHEB	CIVIL ENGINEERING
19	SEA19	DHOKALE BALAJI DADASAHEB	CIVIL ENGINEERING
20	SEA20	DHUMAL GANESH RAJENDRA	CIVIL ENGINEERING
21	SEA21	GADADE SHUBHAM BIRUDEO	CIVIL ENGINEERING
22	SEA22	GAIKWAD KALPESH LAXMAN	CIVIL ENGINEERING
23	SEA23	GAIKWAD ANKITA ASHOK	CIVIL ENGINEERING
24	SEA24	GARDI OMKAR NARENDRA	CIVIL ENGINEERING
25	SEA25	GAVATE HITESH JANARDAN NILIMA	CIVIL ENGINEERING
26	SEA26	GAWADE VAIBHAV SUBHASH	CIVIL ENGINEERING
27	SEA27	GAWALI PRASHANT ARJUN	CIVIL ENGINEERING
28	SEA28	GAWAND DIVYA DINANATH	CIVIL ENGINEERING
29	SEA29	GHADGE SANDESH RAJENDRA	CIVIL ENGINEERING
30	SEA30	GHADI NIKHIL PRAMOD	CIVIL ENGINEERING
31	SEA31	GHARAT VRUSHALI SHIRISH	CIVIL ENGINEERING
32	SEA32	GHARAT DIWANGI MANOJ	CIVIL ENGINEERING

TRUE COPY

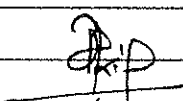

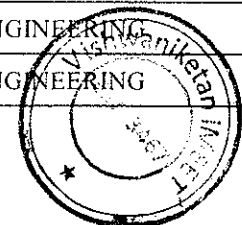
Principal
Vishwaniketan



33	SEA33	GHAVATE RAJANIL	CIVIL ENGINEERING
34	SEA34	GOSAVI HRUSHIKESH SHRIRAM	CIVIL ENGINEERING
35	SEA35	GUJAR SHUBHAM ANIL	CIVIL ENGINEERING
36	SEA36	GURAV NIKHIL UDAY	CIVIL ENGINEERING
37	SEA37	HAJARE VAIBHAV SURESH	CIVIL ENGINEERING
38	SEA38	HANDE RUSHIKESH RAMCHANDRA	CIVIL ENGINEERING
39	SEA39	JADHAV AKSHAY RAMESH	CIVIL ENGINEERING
40	SEA40	JADHAV NIKHIL KAILAS	CIVIL ENGINEERING
41	SEA41	JADHAV NILESH MURALI	CIVIL ENGINEERING
42	SEA42	JADHAV RAHUL SHANKAR	CIVIL ENGINEERING
43	SEA43	JADHAV RAJKUMAR SUNIL	CIVIL ENGINEERING
44	SEA44	JADHAV SARVESH SANDEEP	CIVIL ENGINEERING
45	SEA45	JADHAV SHIVANI ANANT	CIVIL ENGINEERING
46	SEA46	JADHAV SHIVRAJ SHAHAJI	CIVIL ENGINEERING
47	SEA47	JOSHI SIDDHANT GANESH	CIVIL ENGINEERING
48	SEA48	KABURE GAJANAN APPASO	CIVIL ENGINEERING
49	SEA49	KACHARE VIVEK	CIVIL ENGINEERING
50	SEA50	KAMBLE ANKUR RAJESH	CIVIL ENGINEERING
51	SEA51	KAMBLE VIVEK SUNIL	CIVIL ENGINEERING
52	SEA52	KARANJKAR AKASH RAJEBHAU	CIVIL ENGINEERING
53	SEA53	KARDE SHUBHAM PRAKASH	CIVIL ENGINEERING
54	SEA54	KATRODIA MITANSHU MANISH	CIVIL ENGINEERING
55	SEA55	KHADAKBAN SUYOG VAIBHAV	CIVIL ENGINEERING
56	SEA56	KHADE MAYURI DATTATRAY	CIVIL ENGINEERING
57	SEA57	KHALOKAR SUSHANT AJAY	CIVIL ENGINEERING
58	SEA58	KHANDALKAR ADITYA BALKRISHNA	CIVIL ENGINEERING
59	SEA59	KODAG AKASH GORAKH	CIVIL ENGINEERING
60	SEA60	KOLAMBE TUSHAR BHAGWAN	CIVIL ENGINEERING
61	SEA61	KOLEKAR AMOL JAGANNATH	CIVIL ENGINEERING
62	SEA62	KOR GANESH SHANTARAM	CIVIL ENGINEERING
63	SEA63	KOTIWALE AVISHKAR IRAPPA	CIVIL ENGINEERING
64	SEA64	KUMAVAT KARAN ANAND	CIVIL ENGINEERING
65	SEA65	MADAKE ROSHANI SURESH	CIVIL ENGINEERING
66	SEA66	MAHADIK ADITYA KASHINATH	CIVIL ENGINEERING
67	SEA67	MANDAVKAR MANSI SUDHAKAR	CIVIL ENGINEERING
68	SEA68	MANE PRASAD VIKAS	CIVIL ENGINEERING
69	SEA69	MHATRE NISHITA YASHVANT	CIVIL ENGINEERING

TRUE COPY

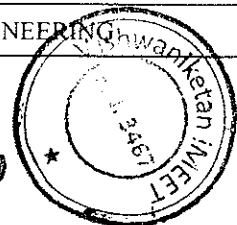
J.P.D.
Principal
Vishwaniketan's (i MEET)



70	SLA70	MHATRE PRANAV VILAS	CIVIL ENGINEERING
71	SEB01	MHATRE PRAHAKESH SHANKAR	CIVIL ENGINEERING
72	SEB02	MHATRE RAHUL ASHOK	CIVIL ENGINEERING
73	SEB03	MHATRE TEJAS HEMANT	CIVIL ENGINEERING
74	SEB04	MOKAL MINAL JAYARAM	CIVIL ENGINEERING
75	SEB05	MULEY PRANAY TEJRAO	CIVIL ENGINEERING
76	SEB06	MULLA SAJADA SHAFAHATAHAMAD	CIVIL ENGINEERING
77	SEB07	NAIK KETAN PADAJI	CIVIL ENGINEERING
78	SEB08	NANDGAONKAR RUTUJA SANTOSH	CIVIL ENGINEERING
79	SEB09	NARVEKAR RUTIK ADIK	CIVIL ENGINEERING
80	SEB10	NIMBALKAR SUPRIYA GANPAT	CIVIL ENGINEERING
81	SEB11	NIVALE BALKRUSHNA LAXMAN	CIVIL ENGINEERING
82	SEB12	PAL SHUBHAM YASHWANT	CIVIL ENGINEERING
83	SEB13	PANDEY ARVIND RAMSAGAR	CIVIL ENGINEERING
84	SEB14	PATEL VEENA DHANJI	CIVIL ENGINEERING
85	SEB15	PATIL SANJANA SANDESH	CIVIL ENGINEERING
86	SEB16	PATIL AKASH GANESH	CIVIL ENGINEERING
87	SEB17	PATIL GITANJALI JAYAWANT	CIVIL ENGINEERING
88	SEB18	PATIL OMKAR SARYAKANT	CIVIL ENGINEERING
89	SEB19	PATIL PARAMVIR PANDURANG	CIVIL ENGINEERING
90	SEB20	PATIL PAYAL KISHOR	CIVIL ENGINEERING
91	SEB21	PATIL PREETI SANTOSH	CIVIL ENGINEERING
92	SEB22	PATIL SAHILEE PARSHURAM	CIVIL ENGINEERING
93	SEB23	PATRIKAR SHASHWAT VINOD	CIVIL ENGINEERING
94	SEB24	PAWAR CHAITANYA MILIND	CIVIL ENGINEERING
95	SEB25	PAWAR DHANANJAY DILIP	CIVIL ENGINEERING
96	SEB26	PAWAR OMKAR NARAYAN	CIVIL ENGINEERING
97	SEB27	PAWAR SANJAY SOMA	CIVIL ENGINEERING
98	SEB28	QUREISHI NOORUDDIN AHMED	CIVIL ENGINEERING
99	SEB29	SALEKAR LAUKIK BHARAT	CIVIL ENGINEERING
100	SEB30	SALUNKE ABHISHEK GANESH	CIVIL ENGINEERING
101	SEB31	SAWANT VIJAY SUNIL	CIVIL ENGINEERING
102	SEB32	SAYYED HASAN AHMED	CIVIL ENGINEERING
103	SEB33	SHAIKH FAIYYAZ SAYYAD	CIVIL ENGINEERING
104	SEB34	SHAIKH UMAMUL JAKIR	CIVIL ENGINEERING
105	SEB35	SHAIKH SAAD ARSHAD	CIVIL ENGINEERING
106	SEB36	SHIRSAT ABHAY VITHOBA	CIVIL ENGINEERING

TRUE COPY

Principal
Vishwanikar

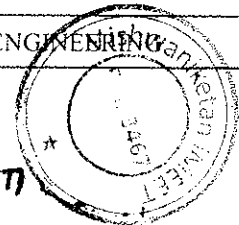

MEET

107	SEB37	SAUNDALKAR AKSHAY SAKHARAM	CIVIL ENGINEERING
108	SEB38	SURVE CHAITANYA SANJAY	CIVIL ENGINEERING
109	SEB39	TAMBADE GOPINATH RAJENDRA	CIVIL ENGINEERING
110	SEB40	TAMBOLI SUSHANT MADHUKAR	CIVIL ENGINEERING
111	SEB41	TEMBARE SIMRAN NANASAHEB	CIVIL ENGINEERING
112	SEB42	THAKUR SAHIL MANOHAR	CIVIL ENGINEERING
113	SEB43	THAKUR VAIBHAV VISHNU	CIVIL ENGINEERING
114	SEB44	VIRULKAR DHANSHRI ISHWAR	CIVIL ENGINEERING
115	SEB45	WAGH SAURABH MADHUKAR	CIVIL ENGINEERING
116	SEB46	WAGHMARE ANKITA ASHOK	CIVIL ENGINEERING
117	SEB47	WAGHULE KETAN BABASAHEB	CIVIL ENGINEERING
118	SEB48	WARKE SHWETA SUDHAKAR	CIVIL ENGINEERING
119	SEB49	YADAV ANIKET MAHENDRA	CIVIL ENGINEERING
120	SEB50	BHALERAO MEGHA RAJU	CIVIL ENGINEERING
121	SEB51	BHUDE VAIBHAV JAGADISH	CIVIL ENGINEERING
122	SEB52	DESHMUKH HRITHWIK SUBHASH	CIVIL ENGINEERING
123	SEB53	DHANAWADE OMKAR SANJAY	CIVIL ENGINEERING
124	SEB54	GAIKWAD ABHIJEET SOPAN	CIVIL ENGINEERING
125	SEB55	JANGAM ROHAN RAVINDRA	CIVIL ENGINEERING
126	SEB56	JOSHI SAGAR SANTOSH	CIVIL ENGINEERING
127	SEB57	KARCHE SURAJ KAILAS	CIVIL ENGINEERING
128	SEB58	KULKARNI PRATHAMESH PRADIP	CIVIL ENGINEERING
129	SEB59	MEHER SHUBHAM NANDKUMAR	CIVIL ENGINEERING
130	SEB60	MAHAJAN ADITYA SUNIL	CIVIL ENGINEERING
131	SEB61	MORE DHIRAJ DNYANESHWAR	CIVIL ENGINEERING
132	SEB62	PATIL ROHIT PRATAPRAO	CIVIL ENGINEERING
133	SEB63	PATIL SHARVIL MANISH	CIVIL ENGINEERING
134	SEB64	SAWANT MANDAR SHRIKRISHNA	CIVIL ENGINEERING
135	SEB65	SINHA SHIVAM PRADEEP	CIVIL ENGINEERING
136	SEB66	THIRTHICKBHARANI TAMIL VANAN	CIVIL ENGINEERING
137	SEB67	TRIPATHI NIKHIL KRISHNACHANDRA	CIVIL ENGINEERING
138	SEB68	VARTAK SHUBHAK DEVIDAS	CIVIL ENGINEERING
139	SEB69	WASKAR SUHAS RAMAN	CIVIL ENGINEERING
140	TEA01	AMBADE VISHAKHA VINOD	CIVIL ENGINEERING
141	TEA02	AWALE SUPRIYA SITARAM	CIVIL ENGINEERING
142	TEA03	BENDRE BHAGYASHREE RAVINDRA	CIVIL ENGINEERING
143	TEA04	BHASE PRANAL RAMBHAJI	CIVIL ENGINEERING

TRUE COPY

Principal
(i MEET)

Vishwanke

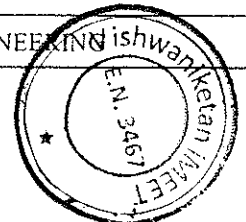

144	TEA05	BHILARE SURAJ PRAKASHI	CIVIL ENGINEERING
145	TEA06	BHOPI ROHAN RAGHUNATH	CIVIL ENGINEERING
146	TEA07	CHAVAN SANKET SURESH	CIVIL ENGINEERING
147	TEA08	CHAVAN VIKAS NAMDEV PURLABAI	CIVIL ENGINEERING
148	TEA09	CHIMANE SANKET SANTOSH	CIVIL ENGINEERING
149	TEA10	CHITTE GAURAV VIKAS	CIVIL ENGINEERING
150	TEA11	DANDEKAR MILAN LALIT	CIVIL ENGINEERING
151	TEA12	DEOKAR YOGESH PITAMBAR	CIVIL ENGINEERING
152	TEA13	DESAI MANGESH PANDURANG	CIVIL ENGINEERING
153	TEA14	DESHMUKHI MAYURI SANJAY CHITRA	CIVIL ENGINEERING
154	TEA15	GADGE AKASH BABAJI SUGANDHA	CIVIL ENGINEERING
155	TEA16	GAIKWAD HARSHADA POPAT	CIVIL ENGINEERING
156	TEA17	GAVHANE RUSHIKESH NAMDEO	CIVIL ENGINEERING
157	TEA18	GAWADE ROHIT DEVAPPA	CIVIL ENGINEERING
158	TEA19	GAWAND NINAD RAVINDRA	CIVIL ENGINEERING
159	TEA20	GAWANDE SANJANA SHAILESH	CIVIL ENGINEERING
160	TEA21	GHANATE HARSHAL BABURAO	CIVIL ENGINEERING
161	TEA22	GHARAT PRADNYA YASHAVANT	CIVIL ENGINEERING
162	TEA23	GODE ABHISHEK JAYDEEP	CIVIL ENGINEERING
163	TEA24	GURAV ADITYA ADESH	CIVIL ENGINEERING
164	TEA25	JADHAV AKASH ARUN	CIVIL ENGINEERING
165	TEA26	JADHAV ANIKET SATISH	CIVIL ENGINEERING
166	TEA27	JADHAV SAMEER RAJENDRA	CIVIL ENGINEERING
167	TEA28	JADHAV SWARAJ JAYANT	CIVIL ENGINEERING
168	TEA29	JOSHI UDAY MAHESH	CIVIL ENGINEERING
169	TEA30	KADAM NIKHIL RAMA	CIVIL ENGINEERING
170	TEA31	KALE PRADEEP RAMCHANDRA	CIVIL ENGINEERING
171	TEA32	KANTHALE SHUBHAM DADANATH	CIVIL ENGINEERING
172	TEA33	KARNUK VRUSHALI RAMBHAJI	CIVIL ENGINEERING
173	TEA34	KAVALE SAURABH SURESH	CIVIL ENGINEERING
174	TEA35	KHAN SAJID AFZAL	CIVIL ENGINEERING
175	TEA36	KHEDEKAR SANKALP SHARAD	CIVIL ENGINEERING
176	TEA37	KOKARE VISHAL BALU	CIVIL ENGINEERING
177	TEA38	KOLI ROHAN JAGAN	CIVIL ENGINEERING
178	TEA39	KOTHEKAR JANHAVI DATTATRAY	CIVIL ENGINEERING
179	TEA40	KULKARNI KAUSTUBH SACHIN	CIVIL ENGINEERING
180	TEA41	KULKARNI PARAG ANANT	CIVIL ENGINEERING

TRUE COPY

[Signature]
Principal
Vishwaniketan

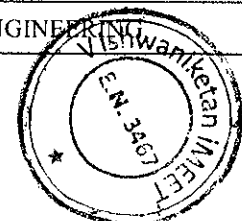

181	TEA42	KUT KARNI SAMEER MAHESH	CIVIL ENGINEERING
182	TEA43	KURANGALE KIRAN KRUSHNA	CIVIL ENGINEERING
183	TEA44	MADANE NANDINI DILIP SUMAN	CIVIL ENGINEERING
184	TEA45	MADHAVI CHAITANYA KISHOR	CIVIL ENGINEERING
185	TEA46	MADHAVI TANMAY DNYANESHWAR	CIVIL ENGINEERING
186	TEA47	MADKE DARSHAN BHARAT	CIVIL ENGINEERING
187	TEA48	MADKE MRUNAL MALHARI	CIVIL ENGINEERING
188	TEA49	MAHABALE SATYAVAN VISHWANATH	CIVIL ENGINEERING
189	TEA50	MAHADIK CHAITANYA CHANDRAKANT LAXMI	CIVIL ENGINEERING
190	TEA51	MALI SAGAR SANTOSH ARCHANA	CIVIL ENGINEERING
191	TEA52	MHATRE BHUSHAN VISHWNATH	CIVIL ENGINEERING
192	TEA53	MHATRE DIKSHITA BALIRAM	CIVIL ENGINEERING
193	TEA54	MHATRE NISHANT CHANDRASHEKHAR ANITA	CIVIL ENGINEERING
194	TEA55	MHATRE PRATIK BHANUDAS	CIVIL ENGINEERING
195	TEA56	MHATRE SIDDHANT SANJAY	CIVIL ENGINEERING
196	TEA57	MHATRE VIPUL SHRIPAT	CIVIL ENGINEERING
197	TEA58	MOHITE MANSEE MOHAN	CIVIL ENGINEERING
198	TEA59	MOKAL HARSHADA VISHAVNATH	CIVIL ENGINEERING
199	TEA60	MOKAL PRAJWAL SUNIL	CIVIL ENGINEERING
200	TEA61	MOKAL SHUBHAM SANTOSH	CIVIL ENGINEERING
201	TEA62	MUJAWAR SALMAN TASLIM WAHIDA	CIVIL ENGINEERING
202	TEA63	MUKKU PRASHANTHAKUMAR VENKA	CIVIL ENGINEERING
203	TEA64	NAGDIVE NIVESH SUDHIR MRUDULA	CIVIL ENGINEERING
204	TEA65	NAIK JAYESH CHANDRAKANT	CIVIL ENGINEERING
205	TEA66	NARANGIKAR HARSHADA ANIL	CIVIL ENGINEERING
206	TEA67	NAVALE SANJEEVANI SURYAKANT	CIVIL ENGINEERING
207	TEB01	OJHA SANJEEVKUMAR TRILOCHAN MEENA	CIVIL ENGINEERING
208	TEB02	OSWAL DUSHANT MANISH SANGITA	CIVIL ENGINEERING
209	TEB03	PADWANKAR SAURABH SANJAY ASHWINI	CIVIL ENGINEERING
210	TEB04	PANDHARE RUSHIKESH DNYANDEV	CIVIL ENGINEERING
211	TEB05	PATIL AARTI PRALHAD	CIVIL ENGINEERING
212	TEB06	PATIL KEDAR SHARAD REKHA	CIVIL ENGINEERING
213	TEB07	PATIL OMKAR KISHOR	CIVIL ENGINEERING
214	TEB08	PATIL OMKAR MADHUKAR	CIVIL ENGINEERING
215	TEB09	PATIL PRATIKSHA YASHWANT	CIVIL ENGINEERING
216	TEB10	PATIL RATNESH RAMAKANT	CIVIL ENGINEERING
217	TEB11	PATIL SAYALI ANIL	CIVIL ENGINEERING

TRUE COPY

AKP
Principal
Vishwanathetan's (iMEET)

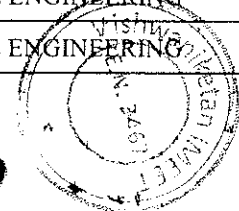

218	TEB12	PATIL SAYLI KISHOR KALAVATI	CIVIL ENGINEERING
219	TEB13	PATIL SHUBHAM MOHAN	CIVIL ENGINEERING
220	TEB14	PATIL TEJASWINI VIKAS	CIVIL ENGINEERING
221	TEB15	PATIL TEJASWINI VIKAS	CIVIL ENGINEERING
222	TEB16	PATIL UMANG DHANAJI	CIVIL ENGINEERING
223	TEB17	PETHE ANKIT RAJENDRA	CIVIL ENGINEERING
224	TEB18	PINGALE ROHINI SANTOSHI	CIVIL ENGINEERING
225	TEB19	POKHARKAR NILESH RAMDAS	CIVIL ENGINEERING
226	TEB20	RANGARI VIPUL DEVANAND	CIVIL ENGINEERING
227	TEB21	SATTAWADEKAR SAURABH RAMESH	CIVIL ENGINEERING
228	TEB22	SALVI PRASENJIT RAJESH	CIVIL ENGINEERING
229	TEB23	SANAP ABHISHEK SHAILESH	CIVIL ENGINEERING
230	TEB24	SAPKAL PIYUSH RAJESH	CIVIL ENGINEERING
231	TEB25	SATVE AKSHAY ANANTA	CIVIL ENGINEERING
232	TEB26	SAVALE BHUPESH HIMMATRAO	CIVIL ENGINEERING
233	TEB27	SAWANT CHIRAG DEEPAK NIRMALA	CIVIL ENGINEERING
234	TEB28	SAWANT PRATIK JAGADISH	CIVIL ENGINEERING
235	TEB29	SHAH VISHESH SANDEEP	CIVIL ENGINEERING
236	TEB30	SHINDE ANKITA PRASHANT SAYALI	CIVIL ENGINEERING
237	TEB31	SHINDE VISHAL PRAKASH	CIVIL ENGINEERING
238	TEB32	SHIRKE ASHITOSH SURESH	CIVIL ENGINEERING
239	TEB33	SINGH SANJU ARUNKUMAR	CIVIL ENGINEERING
240	TEB34	SURYAWANSHI SIDDHANT BANDOPANT	CIVIL ENGINEERING
241	TEB35	THAKUR ABHISHEK ANIL	CIVIL ENGINEERING
242	TEB36	THAKUR OMKAR ANAND NILAM	CIVIL ENGINEERING
243	TEB37	THAKUR SARVESH CHANDRASHEKHAR GITAI	CIVIL ENGINEERING
244	TEB38	THAKUR SHILPA NARAYAN	CIVIL ENGINEERING
245	TEB39	THAKUR VAIBHAV PURUSHOTTAM	CIVIL ENGINEERING
246	TEB40	THUBE PRATIKSHA GITARAM	CIVIL ENGINEERING
247	TEB41	UGHADA VILAS DURGADAS	CIVIL ENGINEERING
248	TEB42	WAGH PANKAJ BALU	CIVIL ENGINEERING
249	TEB43	WAGHMARE BHAGYASHRI MOHAN	CIVIL ENGINEERING
250	TEB44	THORAT ROHIT KISHOR	CIVIL ENGINEERING
251	TEB45	WAKADE SNEHAL PRADEEP	CIVIL ENGINEERING
252	TEB46	BATHIJA KUNAL R	CIVIL ENGINEERING
253	TEB47	BORKAR ADITYA PRADEEP	CIVIL ENGINEERING
254	TEB48	DANDEKAR NIKHIL JAYENDRA	CIVIL ENGINEERING

TRUE COPY

Handwritten signature
Vishwaniketan's (I MEET)

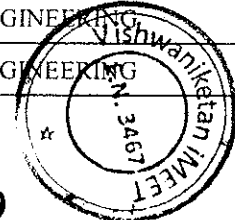

255	TEB49	FERNANDES ALVES	CIVIL ENGINEERING
256	TEB50	KAMBLE ANKUR RAJEEH	CIVIL ENGINEERING
257	TEB51	KUMAVAT KIRAN DAGA	CIVIL ENGINEERING
258	TEB52	KUNDALE SWAPNIL	CIVIL ENGINEERING
259	TEB53	MAHALE KIRAN HARISH	CIVIL ENGINEERING
260	TEB54	MHATRE CHIRAYU JAHINDRANATH	CIVIL ENGINEERING
261	TEB55	MHATRE NISHANT MANOHAR	CIVIL ENGINEERING
262	TEB56	MOTE TEJAS CHANDRAKANT	CIVIL ENGINEERING
263	TEB57	MULEY PRANAY TEJRAO	CIVIL ENGINEERING
264	TEB58	PATIL JAYESH MOHAN	CIVIL ENGINEERING
265	TEB59	PATIL RAHUL SURESH	CIVIL ENGINEERING
266	TEB60	PAWAR ASHUTOSH SHIVAJI	CIVIL ENGINEERING
267	TEB61	PUNYARTHI RUSHIKESH SADANAND	CIVIL ENGINEERING
268	TEB62	SALVI DARSHAN MANOHAR	CIVIL ENGINEERING
269	TEB63	SHARMA VIKASH MANOJ	CIVIL ENGINEERING
270	TEB64	SHETYE RIDDHI ASHISH MANSI	CIVIL ENGINEERING
271	TEB65	SHINDE NIKHIL RAMESH	CIVIL ENGINEERING
272	TEB66	WANALEKAR VARSHA HANUMANTRAO	CIVIL ENGINEERING
273	TEB67	YADAV NIRANJAN VITTHAL	CIVIL ENGINEERING
274	BEA01	AHINAVE NIKHIL JALINDAR	CIVIL ENGINEERING
275	BEA02	AMIRKHAN ABDUL RASID	CIVIL ENGINEERING
276	BEA03	AUTADE KUNAL BHAUSAHEB VIDYA	CIVIL ENGINEERING
277	BEA04	AWARGAND VISHAL LAXMAN VAISHALI	CIVIL ENGINEERING
278	BEA05	BADE ROSHAN JAGDISH MEERA	CIVIL ENGINEERING
279	BEA06	BHAGAT ACHAL VIJAY SARITA	CIVIL ENGINEERING
280	BEA07	BHALEKAR AKSHAY SUBHASH	CIVIL ENGINEERING
281	BEA08	BHANGALE HEMANT PRAMOD	CIVIL ENGINEERING
282	BEA09	BHOIR VIJAY JAGANNATH	CIVIL ENGINEERING
283	BEA10	BHOITE VARSHA NATHA SUMAN	CIVIL ENGINEERING
284	BEA11	BIRADAR AMAR SHRKANT VIDYA	CIVIL ENGINEERING
285	BEA12	CHAUDHARI BHARAT SUNIL KIRTI	CIVIL ENGINEERING
286	BEA13	CHAVAN SHIVRAJ CHANDRAKANT	CIVIL ENGINEERING
287	BEA14	CHAVAN UJJWAL PRAKASH NARANGIDEVI	CIVIL ENGINEERING
288	BEA15	CHAVARKAR NIHAL MILIND	CIVIL ENGINEERING
289	BEA16	CHAWAN RAKESH ROHIDAS	CIVIL ENGINEERING
290	BEA17	CHEPATE RUSHIKESH GAHININATH	CIVIL ENGINEERING
291	BEA18	CHOWDHARI CHINMAY PRAMOD	CIVIL ENGINEERING

TRUE COPY

J.P.
Principal
Vishwanik (I MEET)

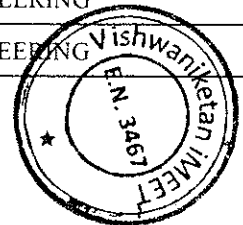

292	BEA19	DESHMANE SAIHITYA RATANI AL RAJANI	CIVIL ENGINEERING
293	BEA20	DESHMUKH SURAJ CHANDRAKANT	CIVIL ENGINEERING
294	BEA21	DHAMANE SANDESH SHEKHAR UJWALA	CIVIL ENGINEERING
295	BEA22	DHOBLE OMKAR RAMCHANDRA	CIVIL ENGINEERING
296	BEA23	DHONGADE SANDHYA DHANANJAY	CIVIL ENGINEERING
297	BEA24	DUDUSKAR ROHAN SURESH SUCHITA	CIVIL ENGINEERING
298	BEA25	GAIKWAD SWAPNIL SURYAKANT	CIVIL ENGINEERING
299	BEA26	GAIKWAD SIDDHESH BHARAT	CIVIL ENGINEERING
300	BEA27	GAMARE SAGAR SUBHASHI	CIVIL ENGINEERING
301	BEA28	GANDAGE SHANKAR SHREEMANT	CIVIL ENGINEERING
302	BEA29	GHARAT KUNAL JAYDEV	CIVIL ENGINEERING
303	BEA30	GUPTA SACHIN RAMKRISHNA MANJU DEVI	CIVIL ENGINEERING
304	BEA31	HARAD JITESH VILAS	CIVIL ENGINEERING
305	BEA32	INGOLE VIJAY DASHRATH	CIVIL ENGINEERING
306	BEA33	JADHAV AKSHAY ASHOK MEENAKSHI	CIVIL ENGINEERING
307	BEA34	JADHAV AKSHAY BABURAO TRUPTI	CIVIL ENGINEERING
308	BEA35	JADHAV JIVAN KRISHNA JAYSHREE	CIVIL ENGINEERING
309	BEA36	JADHAV NISHANT SHANTARAM JAYSHREE	CIVIL ENGINEERING
310	BEA37	JADHAV VISHAL PARSHURAM	CIVIL ENGINEERING
311	BEA38	JAGDALE AMIT LAHURAJ	CIVIL ENGINEERING
312	BEA39	JAIWAL VIJAYLAXMI RAMANAND ASHA	CIVIL ENGINEERING
313	BEA40	JHA DEEPAK SUSHILKUMAR	CIVIL ENGINEERING
314	BEA41	JONDHALE SOHAM SHAILENDRA	CIVIL ENGINEERING
315	BEA42	KAMBLE ANJALI RAJESH (P)	CIVIL ENGINEERING
316	BEA43	KAMBLE KRUTIKA VIJAY	CIVIL ENGINEERING
317	BEA44	KAMBLE SHWETA S. (P)	CIVIL ENGINEERING
318	BEA45	KAMBLE TANMAY DAYANAND	CIVIL ENGINEERING
319	BEA46	KARANDE MAHESH NANDKUMAR SNEHA	CIVIL ENGINEERING
320	BEA47	KASHID PRADIP SHIVAJI MEENA	CIVIL ENGINEERING
321	BEA48	KENI PANKAJ ROHIDAS	CIVIL ENGINEERING
322	BEA49	KHANDAGALE DHIRAJ NANASO NEELAM	CIVIL ENGINEERING
323	BEA50	KHARSAMBALE SONIYA HEMNATH MINAXI	CIVIL ENGINEERING
324	BEA51	KIRVE PRATHAMESH SUNIL RAJASHREE	CIVIL ENGINEERING
325	BEA52	KOLI SATYAJEET HARIDAS ROHINI(P)	CIVIL ENGINEERING
326	BEA53	KURANKAR ANKITA SHREEDHAR	CIVIL ENGINEERING
327	BEA54	LOHAR AKSHAY ARVIND AARTI	CIVIL ENGINEERING
328	BEA55	LOKHANDE VIKAM PRAKASH NANDA	CIVIL ENGINEERING

TRUE COPY

[Signature]
Principles

Vishwaniket (MEET)

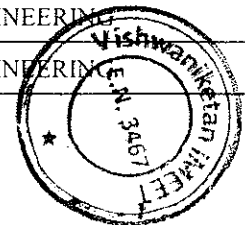

329	BEA56	MALUSARE AKASH ASHOK	CIVIL ENGINEERING
330	BEA57	MANE VISHNU RAMCHANDRA GANGA	CIVIL ENGINEERING
331	BEA58	MHATRE AMITA RAMESH	CIVIL ENGINEERING
332	BEA59	MHATRE CHHAYA SUBHASH SHUBHANGI	CIVIL ENGINEERING
333	BEA60	MHATRE HARSHALI JANARDAN	CIVIL ENGINEERING
334	BEB01	MHATRE KARAN GIRIDHAR	CIVIL ENGINEERING
335	BEB02	MHATRE NIKHIL KAILASH	CIVIL ENGINEERING
336	BEB03	MHATRE PRAJAKTA PRABHAKAR DARSHANA	CIVIL ENGINEERING
337	BEB04	MISAL VAIBHAVI SUNIL	CIVIL ENGINEERING
338	BEB05	MOHITE SHUBHAM ASHOK	CIVIL ENGINEERING
339	BEB06	MORE VISHAKHA RAMCHANDRA UJWALA	CIVIL ENGINEERING
340	BEB07	MUNDKAR CHETAN VISHNU	CIVIL ENGINEERING
341	BEB08	NAIK VIKRANT VISHNU NIRMALA (P)	CIVIL ENGINEERING
342	BEB09	NIMBALKAR VIRAJ VINAYKUMAR	CIVIL ENGINEERING
343	BEB10	OVHAL AKSHITA BHAGWAN	CIVIL ENGINEERING
344	BEB11	PAKHAR YOGESH RAMESH RAMILA	CIVIL ENGINEERING
345	BEB12	PATIL AKASH CHANDRAKANT	CIVIL ENGINEERING
346	BEB13	PATIL ANIKET ARUN NANDA	CIVIL ENGINEERING
347	BEB14	PATIL BHAVESH HEMCHANDRA BHARTI	CIVIL ENGINEERING
348	BEB15	PATIL DIPIL VIJAY	CIVIL ENGINEERING
349	BEB16	PATIL GIRISH PANDIT	CIVIL ENGINEERING
350	BEB17	PATIL HARSHADA GAJENDRA SANGITA	CIVIL ENGINEERING
351	BEB18	PATIL MANALI MADHUKAR	CIVIL ENGINEERING
352	BEB19	PATIL NIVRUTTI ANKUSH	CIVIL ENGINEERING
353	BEB20	PATIL PAYAL EKNATH	CIVIL ENGINEERING
354	BEB21	PATIL PRACHIT PRAMOD	CIVIL ENGINEERING
355	BEB22	PATIL PRANAV PRABHAKAR	CIVIL ENGINEERING
356	BEB23	PATIL PRANIT ANIL ANITA	CIVIL ENGINEERING
357	BEB24	PATIL RAHUL TUKARAM	CIVIL ENGINEERING
358	BEB25	PATIL RUPALI VASUDEV	CIVIL ENGINEERING
359	BEB26	PATIL SAGAR SANDEEP SMITA	CIVIL ENGINEERING
360	BEB27	PATIL SHUBHAM MOHAN	CIVIL ENGINEERING
361	BEB28	PATIL VARSHA DHANANJAY	CIVIL ENGINEERING
362	BEB29	POPHALE VIJAY RAJARAM DIPIKA	CIVIL ENGINEERING
363	BEB30	RAJGURU MAYURI	CIVIL ENGINEERING
364	BEB31	RAUT YOGESH RAJENDRA	CIVIL ENGINEERING
365	BEB32	REDDY SONIA RAKESH	CIVIL ENGINEERING

TRUE COPY

[Signature]
Principal
Vishwaniketan's (MEEET)

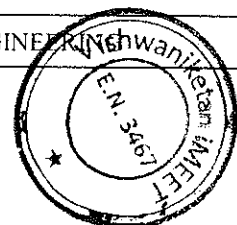

366	BEB33	RUPANVAR AKASH DATTU	CIVIL ENGINEERING
367	BEB34	SAGWIKAR ROHAN PRAKASH JYOTI	CIVIL ENGINEERING
368	BEB35	SANGE SUSHANT SANTOSH SANGEETA	CIVIL ENGINEERING
369	BEB36	SHAHASANE DURVESH UDAYKUMAR MEGHA	CIVIL ENGINEERING
370	BEB37	SHAIKH NIHAL AHMED BILAL FARZANA	CIVIL ENGINEERING
371	BEB38	SHENDGE MEGHA LAXMAN SHALAN	CIVIL ENGINEERING
372	BEB39	SHIGWAN SURAJ DNYANESHWAR NILAM	CIVIL ENGINEERING
373	BEB40	SHINDE SHUBHAM LACCANNATH	CIVIL ENGINEERING
374	BEB41	SHINDE SHUBHAM SUDHIR	CIVIL ENGINEERING
375	BEB42	SHIRKE KRUTIKA KISAN	CIVIL ENGINEERING
376	BEB43	SOLKAR ROHIT RAJENDRA	CIVIL ENGINEERING
377	BEB44	SONAWANE SHUBHAM HIRALAL	CIVIL ENGINEERING
378	BEB45	SURVASE PRATIK DHANRAJ ANITA	CIVIL ENGINEERING
379	BEB46	SURYAVANSHI ADITYA ANGAD ANITA	CIVIL ENGINEERING
380	BEB47	SURYAWANASHI MAYUR DINKAR PREMA	CIVIL ENGINEERING
381	BEB48	TAMAKHE MANGESH BIRA KAMAL	CIVIL ENGINEERING
382	BEB49	TAMGADGE ANIKET ANIL	CIVIL ENGINEERING
383	BEB50	VAGHANI PARTH DEVSHI	CIVIL ENGINEERING
384	BEB51	WADIKAR SARVESH SHASHIKANT SULBHA	CIVIL ENGINEERING
385	BEB52	WAGHMARE ABHIJIT SUNIL	CIVIL ENGINEERING
386	BEB53	WALSHINGE SHRADHA ARUN	CIVIL ENGINEERING
387	BEB54	WASKAR PRATHAMESH KISHOR	CIVIL ENGINEERING
388	BEB55	YADAV RAJ DEEPAK (P)	CIVIL ENGINEERING
389	BEB56	YADAV SAURABH PRAVIN	CIVIL ENGINEERING
390	BEB57	ZIMBAL GIRISH VISHNU SANGEETA	CIVIL ENGINEERING
391	BEB58	BADE ASHWINI AJINATH	CIVIL ENGINEERING
392	BEB59	RANE VISHWADH PRASHANT	CIVIL ENGINEERING
393	SCS01	ABHANG SHRUTI TANAJI	COMPUTER ENGINEERING
394	SCS02	BHADANE GAURAV BHAYYASAHEB	COMPUTER ENGINEERING
395	SCS03*	BHAGAT SIDDHI RAMAKANT	COMPUTER ENGINEERING
396	SCS04	BHALERAO PRATIK PANDURANG	COMPUTER ENGINEERING
397	SCS05	BHOLE YASH VILAS	COMPUTER ENGINEERING
398	SCS06*	BHOSALE ANURAJ CHANDRAKANT	COMPUTER ENGINEERING
399	SCS07	BURANGE POONAM GOVIND	COMPUTER ENGINEERING
400	SCS08	CHAVAN AAYUDH RAVINDRA	COMPUTER ENGINEERING
401	SCS09	DHAKANE SACHIN SANJAY	COMPUTER ENGINEERING
402	SCS10	DUBEY KAMAL PRABHATKANT	COMPUTER ENGINEERING

TRUE COPY

JKP

Principal

Vishwanathan's (PVT) (P) LTD

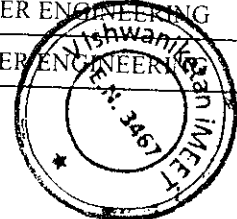

403	SCS11*	GAWADE SAMRUDDHI SANTOSH	COMPUTER ENGINEERING
404	SCS12	GURAV SAMIKSHA MAHESH	COMPUTER ENGINEERING
405	SCS13	HEGDE SUDEEP DEEPAK	COMPUTER ENGINEERING
406	SCS14	HINDALEKAR HRISHIKESH VIJAY	COMPUTER ENGINEERING
407	SCS15	HUDGI GURURAJ MALLIKARJUN	COMPUTER ENGINEERING
408	SCS16	JADHAV AKASH BALASAHEB	COMPUTER ENGINEERING
409	SCS17	JAPE SUPRIYA BABAN	COMPUTER ENGINEERING
410	SCS18	JOSHI VENKATESH ARUN	COMPUTER ENGINEERING
411	SCS19*	JUIKAR RIYA HEMANT	COMPUTER ENGINEERING
412	SCS20*	KADAM PRANALI DILIP	COMPUTER ENGINEERING
413	SCS21*	KALBHOR SUMIT SUBHASH	COMPUTER ENGINEERING
414	SCS22*	KANSE KIRAN MAHADEV	COMPUTER ENGINEERING
415	SCS23	KAPSE AJINKYA CHANDRAKANT	COMPUTER ENGINEERING
416	SCS24	KASLE VEDANT GOVIND	COMPUTER ENGINEERING
417	SCS25	KHOPADE SWARAJ SHRIDHAR	COMPUTER ENGINEERING
418	SCS26	KUNTE HARSH DEEPAK	COMPUTER ENGINEERING
419	SCS27	MAHTO DIYA DINESHKUMAR	COMPUTER ENGINEERING
420	SCS28	MALKAR MANASI DINESH	COMPUTER ENGINEERING
421	SCS29*	MHATRE RASHMI UPENDRA	COMPUTER ENGINEERING
422	SCS30	MHATRE UPASANA SHIVDAS	COMPUTER ENGINEERING
423	SCS31	MISHRA NEHA DIGVIJAY MITHILESH	COMPUTER ENGINEERING
424	SCS32	MISTRY JYOTI DEBIDAS	COMPUTER ENGINEERING
425	SCS33	MOHITE DIVYANKA DIPAK	COMPUTER ENGINEERING
426	SCS34	MOKAL AKSHAYA NAMDEV	COMPUTER ENGINEERING
427	SCS35	MOKAL KARISHMA GAJANAN	COMPUTER ENGINEERING
428	SCS36	MOKAL VAISHNAVI PRABHAKAR	COMPUTER ENGINEERING
429	SCS37*	MOURYA ANKITA HIRA	COMPUTER ENGINEERING
430	SCS38	NALAGE CHAITANYA GANPAT	COMPUTER ENGINEERING
431	SCS39	NANDGAONKAR SHARVARI RAJENDRA	COMPUTER ENGINEERING
432	SCS40	PATEL NARESH KANARAM	COMPUTER ENGINEERING
433	SCS41*	PATIL DHANSHREE SUBHASH	COMPUTER ENGINEERING
434	SCS42	PATIL JAYESH HIRALAL	COMPUTER ENGINEERING
435	SCS43*	PATIL PURNIMA RAJENDRA	COMPUTER ENGINEERING
436	SCS44	PATIL SOURAV RAJARAM	COMPUTER ENGINEERING
437	SCS45	PATLE MOHAN JAIKRISHNA	COMPUTER ENGINEERING
438	SCS46	PATOLE NUTAN UTTAM	COMPUTER ENGINEERING
439	SCS47	PAWAR MANSI JAYAWANT	COMPUTER ENGINEERING

TRUE COPY

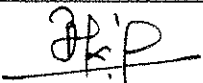
Principal
Vishwaniketan's (PVT) LTD

440	SCS48	PAWAR SONIKA SAMPAT	COMPUTER ENGINEERING
441	SCS49*	RAUT ANIKET SANJAY	COMPUTER ENGINEERING
442	SCS50	RAUT NEHA ANIL	COMPUTER ENGINEERING
443	SCS51	RAWATE AASHUTOSH KAILAS	COMPUTER ENGINEERING
444	SCS52	RAY APRITAM	COMPUTER ENGINEERING
445	SCS53	SASANE DAKSHATA SANJAU	COMPUTER ENGINEERING
446	SCS54	SATHE SUCHITRA SURESH	COMPUTER ENGINEERING
447	SCS55	SHAIK: RAHAT HAMID	COMPUTER ENGINEERING
448	SCS56	SHELAR NAJUKA DINESH	COMPUTER ENGINEERING
449	SCS57	SHELKE AJAY MANOHAR	COMPUTER ENGINEERING
450	SCS58	SHERKHANE SNEHA SHESHRAO	COMPUTER ENGINEERING
451	SCS59	SHUKLA VISHAL ANJANI	COMPUTER ENGINEERING
452	SCS60	SINGH ROSHANI FIRNATH	COMPUTER ENGINEERING
453	SCS61	SINGH SAMIKSHA PRATAP	COMPUTER ENGINEERING
454	SCS62	SOMWANSHI ANIKET ASHOK	COMPUTER ENGINEERING
455	SCS63	TAPARE SHANTANU SUDHIR	COMPUTER ENGINEERING
456	SCS64	TELANGHE ADITYA PRAFULL	COMPUTER ENGINEERING
457	SCS65	THALE SRUSHTI NAYAN	COMPUTER ENGINEERING
458	SCS66	THALE VAISHNAVI DINESH	COMPUTER ENGINEERING
459	SCS67	THORAT PRATIKSHA YASHWANT	COMPUTER ENGINEERING
460	SCS68	UGALE JANHAVI MADHUKAR	COMPUTER ENGINEERING
461	SCS69	UPADHYAY TIRTH JAYESH	COMPUTER ENGINEERING
462	SCS70	VISHWAKARMA AJAY RAMHARSHI	COMPUTER ENGINEERING
463	SCS71	WAKDE SHIRIN SUBHASH	COMPUTER ENGINEERING
464	SCS72	WATEKAR KOMAL SHASHIKANT	COMPUTER ENGINEERING
465	SCS73	ZALTE RAVINA VITTHAL	COMPUTER ENGINEERING
466	TE01*	ANANDRAO SACHIN BHIMRAO	COMPUTER ENGINEERING
467	TE02*	ANCHALKAR TANMAY UMESH	COMPUTER ENGINEERING
468	TE03*	CHIKHALEKAR SNEHANKIT JANARDAN	COMPUTER ENGINEERING
469	TE04*	CHOURASIYA PAWANKUMAR S	COMPUTER ENGINEERING
470	TE05*	DALAL PRATHAMESH MANGESH	COMPUTER ENGINEERING
471	TE06*	DESHMUKH SAGAR JAGDISH	COMPUTER ENGINEERING
472	TE07*	GAIKWAD PRANAY PRAKASH	COMPUTER ENGINEERING
473	TE08*	GUPTA PRATIK MAHESH	COMPUTER ENGINEERING
474	TE09*	GUPTA SUJITKUMAR SANTOSH	COMPUTER ENGINEERING
475	TE10*	KANASE ABHISHEK ASHOK	COMPUTER ENGINEERING
476	TE11*	KULKARNI NARAYAN RAJESHWAR	COMPUTER ENGINEERING

TRUE COPY

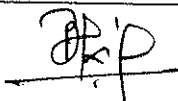

Principal
Vishwaniketan's (Ist MEET)

477	TE12*	KUMAR SONAL ARUN	COMPUTER ENGINEERING
478	TE13*	LAMTURE SIMRAN JAHANGIR	COMPUTER ENGINEERING
479	TE14*	MANE DEEPALI GOPAL	COMPUTER ENGINEERING
480	TE15*	MOKAL GUNVANT VITTHAL	COMPUTER ENGINEERING
481	TE16*	PALANDE AVDHUT ATUL	COMPUTER ENGINEERING
482	TE17*	PATIL AMEY ANKUSH	COMPUTER ENGINEERING
483	TE18*	PATIL SWAPNIL RAMCHANDRA	COMPUTER ENGINEERING
484	TE19*	PAWAR SAMRUDDHI SANJAY	COMPUTER ENGINEERING
485	TE20*	PAWAR SAURABH SURENDRA	COMPUTER ENGINEERING
486	TE21*	POOJARY ABHISHEK RAVI	COMPUTER ENGINEERING
487	TE22*	RAI SAIPRASAD MANHOR	COMPUTER ENGINEERING
488	TE23*	RAJPUT RITENDRAPRATAP SINGH J	COMPUTER ENGINEERING
489	TE24*	SANGHAVI MAYANK ATUL	COMPUTER ENGINEERING
490	TE25*	SAWANT SIDDESH ASHOK	COMPUTER ENGINEERING
491	TE26*	SAYYED ALFIYA RASHID	COMPUTER ENGINEERING
492	TE27*	SHARMA DEEPIKA BHAGWAN	COMPUTER ENGINEERING
493	TE28*	SHINGARE PRASHANT DEEPAK	COMPUTER ENGINEERING
494	TE29*	SINGH RUPESHKUMAR NARENDRA	COMPUTER ENGINEERING
495	TE30*	TARANGE HARSHADA PRATAP	COMPUTER ENGINEERING
496	TE31*	VAVIYA ANAND BECHARABAI	COMPUTER ENGINEERING
497	TE32*	VERMA SANDEEP SURENDRA	COMPUTER ENGINEERING
498	TE33*	VINJAMURI VEDHAS SESHASAI	COMPUTER ENGINEERING
499	TE34	ATTAR NAMRA IQBAL	COMPUTER ENGINEERING
500	TE35	BHOIR JAYESH RAMAKANT	COMPUTER ENGINEERING
501	TE36	CHAVAN OMKAR TANAJI	COMPUTER ENGINEERING
502	TE37	DALVI SAURABH GAJANAN	COMPUTER ENGINEERING
503	TE38	DANDEKAR SNEHAL RAJENDRA	COMPUTER ENGINEERING
504	TE39	GALAVE SAGAR SHANKAR	COMPUTER ENGINEERING
505	TE40	GAWAS SONALI RAMKRISHNA	COMPUTER ENGINEERING
506	TE41	GHARAT SANDESH BHARAT	COMPUTER ENGINEERING
507	TE42	GURAV KOMAL RAVINDRA	COMPUTER ENGINEERING
508	TE43	KAKADE AISHWARYA SATISH	COMPUTER ENGINEERING
509	TE44	KALE MONIKA DEVAJI	COMPUTER ENGINEERING
510	TE45	KHEDKAR AISHWARYA RAJENDRA	COMPUTER ENGINEERING
511	TE46	MASANE GAURI DATTATREY	COMPUTER ENGINEERING
512	TE47	MHATRE TRIVENI PARSHURAM	COMPUTER ENGINEERING
513	TE48	MHATRE VAIBHAV NARESH	COMPUTER ENGINEERING

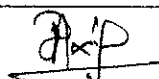

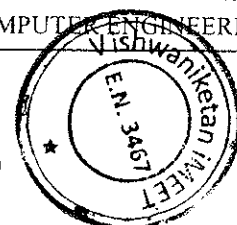
 Principal
Vishwaniketan's (i MEET)



514	TE49	MOKAL VARUN VIKAS	COMPUTER ENGINEERING
515	TE50	PANDEY VISHANT RAMESHWAR	COMPUTER ENGINEERING
516	TE51	PARANGE SHUBHAM RAJENDRA	COMPUTER ENGINEERING
517	TE52	PATIL JAGRUTI ANIL	COMPUTER ENGINEERING
518	TE53	PATIL JYOTI RAMESH	COMPUTER ENGINEERING
519	TE54	PATIL KUNAL VIJAY	COMPUTER ENGINEERING
520	TE55	PATIL MANASI JAGGNATH	COMPUTER ENGINEERING
521	TE56	PATIL MONALI HARISHCHANDRA	COMPUTER ENGINEERING
522	TE57	PATIL RUTUJA ANKUSH	COMPUTER ENGINEERING
523	TE58	PATIL TEJAS BALU	COMPUTER ENGINEERING
524	TE59	PAWAR PRIYA SANDEEP	COMPUTER ENGINEERING
525	TE60	PUJARI AISHWARYA SHIVAJI	COMPUTER ENGINEERING
526	TE61	SALVI AKSHAY NANDKUMAR	COMPUTER ENGINEERING
527	TE62	SANKPAL ASHISH SHANKAR	COMPUTER ENGINEERING
528	TE63	SAPANE AKSHAY PRAKASH	COMPUTER ENGINEERING
529	TE64	SARANG DHIRAJ DNYANRAJ	COMPUTER ENGINEERING
530	TE65	SHEWALE SHUBHAM LAXMAN	COMPUTER ENGINEERING
531	TE66	SHINDE VISHAL SATISH	COMPUTER ENGINEERING
532	TE67	SOLANKI AKSHAY MUKESH	COMPUTER ENGINEERING
533	TE68	SURYAVANSHI VINAYAK MANOJ	COMPUTER ENGINEERING
534	TE69	THAKUR NIKITA JAGDISH	COMPUTER ENGINEERING
535	TE70	THONGE VISHAKHA VIKAS	COMPUTER ENGINEERING
536	BE01*	ABHANG PRANITA MARUTI	COMPUTER ENGINEERING
537	BE02*	BHANDARI RICHA SARITA	COMPUTER ENGINEERING
538	BE03*	CHAVAN AJAY ARUN	COMPUTER ENGINEERING
539	BE04*	CHAVAN KIRAN MHATARDEV	COMPUTER ENGINEERING
540	BE05*	DAS PRAVIN JAYKANT	COMPUTER ENGINEERING
541	BE06*	DESHMUKH MAITHILI SURESH	COMPUTER ENGINEERING
542	BE07*	DIGHORE KAJAL VASANT	COMPUTER ENGINEERING
543	BE08*	KARVE ROHAN CHANDRAKANT	COMPUTER ENGINEERING
544	BE09*	KAUSHIK RAJNISH PAWAN	COMPUTER ENGINEERING
545	BE10*	KISAVE AKSHAY MANOHAR	COMPUTER ENGINEERING
546	BE11*	PAWAR SHREEHARI CHANDRASHEKHAR	COMPUTER ENGINEERING
547	BE12*	SAHANI SANJAY RAMAWADH	COMPUTER ENGINEERING
548	BE13*	SANAS AKSHAY ASHOK	COMPUTER ENGINEERING
549	BE14*	SANKHE SAISH ANIL	COMPUTER ENGINEERING
550	BE15*	SATRE VIKRAM VITTHAL	COMPUTER ENGINEERING

TRUE COPY

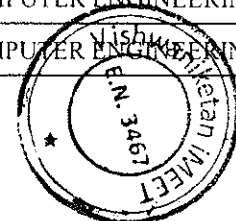
Principal
Vishwaniketan's (I MEET)



551	BE16*	SHELAR NIKHITA NANDKUMAR	COMPUTER ENGINEERING
552	BE17*	SHINDE PURVA RANJIT	COMPUTER ENGINEERING
553	BE18*	SINGH ABHISHEK OMPRAKASH	COMPUTER ENGINEERING
554	BE19	AHIRE NISHIGANDA RAMESH	COMPUTER ENGINEERING
555	BE20	AVALE RANJANA VINAYAK	COMPUTER ENGINEERING
556	BE21	AWASKAR ELIYAHOO JOEL	COMPUTER ENGINEERING
557	BE22	BADGUJAR MANASI SUNIL	COMPUTER ENGINEERING
558	BE23	BANDAWANE TEJAS SUBHASHI	COMPUTER ENGINEERING
559	BE24	BORSE GAURI RAJENDRA	COMPUTER ENGINEERING
560	BE25	CHAUDHARI DEEPA BHIMRAO	COMPUTER ENGINEERING
561	BE26	CHAVAN SHUBHAM ANANDRAO	COMPUTER ENGINEERING
562	BE27	DABIR JITESH KASHINATH	COMPUTER ENGINEERING
563	BE28	DHEMBRE SHWETALI APPASAHEB	COMPUTER ENGINEERING
564	BE29	DHUMAL JUILLEE ROHIDAS	COMPUTER ENGINEERING
565	BE30	GANGANE TEJALI RAMESH	COMPUTER ENGINEERING
566	BE31	GHOSH SOURABH NARAYAN	COMPUTER ENGINEERING
567	BE32	GUPTA SHRISTI GULAB	COMPUTER ENGINEERING
568	BE33	JADHAV ATUL SATISH	COMPUTER ENGINEERING
569	BE34	JADHAV SHEKHAR ASHOK	COMPUTER ENGINEERING
570	BE35	JADHAV SHRADDHA SAMBHAJIRAO	COMPUTER ENGINEERING
571	BE36	JADHAV SHREYA SAMBHAJIRAO	COMPUTER ENGINEERING
572	BE37	KACHALE VARSHA MACHHINDRA	COMPUTER ENGINEERING
573	BE38	KALEKAR JAGRUTI EKNATH	COMPUTER ENGINEERING
574	BE39	KOLI SHRADDHA JAGAN	COMPUTER ENGINEERING
575	BE40	KUBAL SANIKA VILAS	COMPUTER ENGINEERING
576	BE41	MADHAVI PRADNYA DILIP	COMPUTER ENGINEERING
577	BE42	MAPARA JAFAR YASIN	COMPUTER ENGINEERING
578	BE43	MISHRA SATYAPRAKASH NAVNEET	COMPUTER ENGINEERING
579	BE44	MUNDE ARPITA ANANT	COMPUTER ENGINEERING
580	BE45	NAGLE TANVI PARAG	COMPUTER ENGINEERING
581	BE46	PACHPOR RAM SANJAY	COMPUTER ENGINEERING
582	BE47	PANCHAL DARSHANA SATISH	COMPUTER ENGINEERING
583	BE48	PASHILKAR MADHURA RAJENDRA	COMPUTER ENGINEERING
584	BE49	PATHAK SHAGUN SUDHISH	COMPUTER ENGINEERING
585	BE50	PATIL AISHWARYA CHANDRAKANT	COMPUTER ENGINEERING
586	BE51	PATIL HARSHADA BHARAT	COMPUTER ENGINEERING
587	BE52	PATIL PRASAD SHANTARAM	COMPUTER ENGINEERING

TRUE COPY

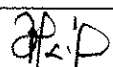

Principal

Vishwaniketan's (I MEET)

588	BE53	PATIL PRITI DEEPAK	COMPUTER ENGINEERING
589	BE54	PATIL SAMPADA SANJAY	COMPUTER ENGINEERING
590	BE55	PATIL SANJOG SANJAY	COMPUTER ENGINEERING
591	BE56	PATIL SHUBHAM PRADEEP	COMPUTER ENGINEERING
592	BE57	PATIL SNEHAL RAMCHANDRA	COMPUTER ENGINEERING
593	BE58	PATIL VISHAL BHAGWAN	COMPUTER ENGINEERING
594	BE59	RAMANE SAYALI ARVIND	COMPUTER ENGINEERING
595	BE60	SAWANT RAJASHREE VASANT	COMPUTER ENGINEERING
596	BE61	SHARMA AARTI DEVIDAYAL	COMPUTER ENGINEERING
597	BE62	SHETTY MANJUSHI SANTOSH	COMPUTER ENGINEERING
598	BE63	SHIRGAONKAR TEJAS GIRISH	COMPUTER ENGINEERING
599	BE64	SINGH POOJA KAMESHWAR	COMPUTER ENGINEERING
600	BE65	SINGH SURUCHI SANTOSH	COMPUTER ENGINEERING
601	BE66	SOMWANSHI ADITYA ASHOK	COMPUTER ENGINEERING
602	BE67	SURVE DAMINI SUDHIR	COMPUTER ENGINEERING
603	BE68	THAKARE ASHWINI TULSHIRAM	COMPUTER ENGINEERING
604	BE69	THORAT KUNAL ADHIKRAO	COMPUTER ENGINEERING
605	BE70	TYAGI ISHITA UDYANKUMAR	COMPUTER ENGINEERING
606	BE71	WAGHMARE PRITISH RAVINDRA	COMPUTER ENGINEERING
607	BE72	WAGHULE ASAWARI KAMALAKAR	COMPUTER ENGINEERING
608	BE73	WAKATI PRATIK SHESHNATH	COMPUTER ENGINEERING
609	BE74	WALKE MAHESH SANJAY	COMPUTER ENGINEERING
610	BE75	WANKHEDE SNEHA ANIL	COMPUTER ENGINEERING
611	BE76	YEWALE OMKAR VILAS	COMPUTER ENGINEERING
612	SE01	BAIKAR RUTIK RAMCHANDRA	ELECTRICAL ENGINEERING
613	SE02	BANGAR AKASH ARJUN SAUBAI	ELECTRICAL ENGINEERING
614	SE03	BARJE SWARUP SAKHARAM	ELECTRICAL ENGINEERING
615	SE04	BENDRE ANIKET PRATAP	ELECTRICAL ENGINEERING
616	SE05	BHAGAT ANUKSHKA VINOD VINITA	ELECTRICAL ENGINEERING
617	SE06	BORADE RUSHIKESH RAVINDRA	ELECTRICAL ENGINEERING
618	SE07	CHAKRABORTY NISHANT PARTHA RITA	ELECTRICAL ENGINEERING
619	SE08	CHAVAN OMKAR LAXMAN	ELECTRICAL ENGINEERING
620	SE09	CHOUDHARI SAYALI SUNIL SHWETA	ELECTRICAL ENGINEERING
621	SE10	DAHIMBEKAR TEJAL ANIL	ELECTRICAL ENGINEERING
622	SE11	DALE ROHAN RAJESH	ELECTRICAL ENGINEERING
623	SE12	DALVI SAYALI RAMESH RESHMA	ELECTRICAL ENGINEERING
624	SE13	DAREKAR AVINASH SUBHASH	ELECTRICAL ENGINEERING

TRUE COPY

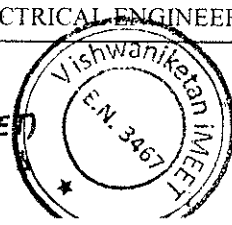
J.P.
Principal
Vishwaniketan's (i MEEET)



625	SE14	DESHMUKH TUSHAR VIJAY	ELECTRICAL ENGINEERING
626	SE15	DHAPATE SWAPNIL CHANDRAKANT SAVITA	ELECTRICAL ENGINEERING
627	SE16	DHURI YOGITA KAMALAKAR	ELECTRICAL ENGINEERING
628	SE17	GAIKAR JAY RAVINDRA SARITA	ELECTRICAL ENGINEERING
629	SE18	GAIKWAD SAURABH	ELECTRICAL ENGINEERING
630	SE19	GAIKWAD VIJAY SHIVAJI MANISHA	ELECTRICAL ENGINEERING
631	SE20	GAMARE SURAJ SANTOSH	ELECTRICAL ENGINEERING
632	SE21	GHANVAT AMIT MARUTI	ELECTRICAL ENGINEERING
633	SE22	GHARAT VINAYA SANDESH	ELECTRICAL ENGINEERING
634	SE23	GHORPADE ABHIJEET SAMBHAJI	ELECTRICAL ENGINEERING
635	SE24	GHUME SHREENIVAS BALAJI	ELECTRICAL ENGINEERING
636	SE25	GOYAL PRUTHVI SHIVRAM SHOBA	ELECTRICAL ENGINEERING
637	SE26	HUKE SUPRAJ SUBODH PRAGATI	ELECTRICAL ENGINEERING
638	SE27	JADHAV MAYUR MANOJ	ELECTRICAL ENGINEERING
639	SE28	JADHAV OMKAR MARUTI LAXMI [TFWS]	ELECTRICAL ENGINEERING
640	SE29	JOSHI SHRUTI SUDHIR	ELECTRICAL ENGINEERING
641	SE30	KAMBLE UTKARSH SHRIMANT MAHANANDA	ELECTRICAL ENGINEERING
642	SE31	KASARE SAGAR DILIP	ELECTRICAL ENGINEERING
643	SE32	LADGE ANUJA DHANANJAY SAROJ [TFWS]	ELECTRICAL ENGINEERING
644	SE33	LANDGE SHRADDHA BHASKAR SHREEYA	ELECTRICAL ENGINEERING
645	SE34	LIMAYE MIHIR MANDAR MINAL	ELECTRICAL ENGINEERING
646	SE35	MADAN PALLAVI BABURAO SHASHEKALA	ELECTRICAL ENGINEERING
647	SE36	MALI HARSHALI PRABHAKAR	ELECTRICAL ENGINEERING
648	SE37	MHATRE DIKSHA MAHADEV	ELECTRICAL ENGINEERING
649	SE38	MHATRE KARAN KISHOR SAVITA	ELECTRICAL ENGINEERING
650	SE39	MHATRE SIDDHESH DEVIDAS	ELECTRICAL ENGINEERING
651	SE40	MOKAL NISHNAT KRISHNA VANDANA	ELECTRICAL ENGINEERING
652	SE41	NAGARKAR NAMRATA CHINTAMAN	ELECTRICAL ENGINEERING
653	SE42	NARAYANKAR RISHABH BHASKAR	ELECTRICAL ENGINEERING
654	SE43	NHAVKAR NIRANJAN MANDEV	ELECTRICAL ENGINEERING
655	SE44	PADALKAR PRATIK PANDURANG	ELECTRICAL ENGINEERING
656	SE45	PARDESHI PRITAM KISHOR	ELECTRICAL ENGINEERING
657	SE46	PARTHE VAIBHAV VIJAY	ELECTRICAL ENGINEERING
658	SE47	PATHARE DARSHAN SURESH	ELECTRICAL ENGINEERING
659	SE48	PATIL AJAY DILIP DIPALI	ELECTRICAL ENGINEERING
660	SE49	PATIL ASMIT KAILAS ARCHANA	ELECTRICAL ENGINEERING
661	SE50	PATIL BHAGYESH KIRAN MINAKSHI	ELECTRICAL ENGINEERING

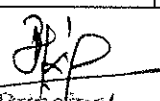

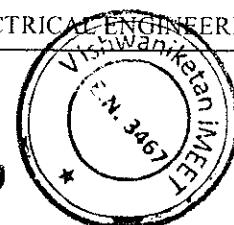
 Principal
Vishwaniketan's (I.A.EET)



662	SE51	PATIL HARSHAL SADANAND	ELECTRICAL ENGINEERING
663	SE52	PATIL MAHENDRA CHHOTULAL ASHA	ELECTRICAL ENGINEERING
664	SE53	PATIL NAYAN GOPINATH KALPANA	ELECTRICAL ENGINEERING
665	SE54	PATIL NIHAR SANJAY NAYNA	ELECTRICAL ENGINEERING
666	SE55	PATIL SHRADIHA RAMESH SUGANDHA	ELECTRICAL ENGINEERING
667	SE56	PATIL SHUBHAM B	ELECTRICAL ENGINEERING
668	SE57	PATIL SHUBHAM H	ELECTRICAL ENGINEERING
669	SE58	PATIL SIDDHESH KESARINATH KIRTI	ELECTRICAL ENGINEERING
670	SE59	SABLE OMKAR PRAVIN	ELECTRICAL ENGINEERING
671	SE60	SALUNKHE SURAJ SUBHASH	ELECTRICAL ENGINEERING
672	SE61	SALUNKHE TEJAS HANUMANT RANJANA	ELECTRICAL ENGINEERING
673	SE62	SHELKE RAVI KANU	ELECTRICAL ENGINEERING
674	SE63	SHINGARE ADITYA SHRIKANT BHAGYASHREE	ELECTRICAL ENGINEERING
675	SE64	SHIRKE KALPESH ANKUSH	ELECTRICAL ENGINEERING
676	SE65	SUTAR SHUBHAM SHASHIKANT SHOBHA	ELECTRICAL ENGINEERING
677	SE66	TANDEL PANKAJ DHANAJI PRATIKSHA	ELECTRICAL ENGINEERING
678	SE67	TARU AMEY RAVINDRA SUNITA	ELECTRICAL ENGINEERING
679	SE68	THAKUR BHAVANA DHANAJI	ELECTRICAL ENGINEERING
680	SE69	THAKUR RAHUL RAMESH	ELECTRICAL ENGINEERING
681	SE70	THALE SHREYAS SHRIKANT RANJANA	ELECTRICAL ENGINEERING
682	SE71	THALE TEJAL VIKAS	ELECTRICAL ENGINEERING
683	SE72	TODANKAR VIPRESH DIGAMBAR	ELECTRICAL ENGINEERING
684	SE73	TORASKAR TEJASHREE	ELECTRICAL ENGINEERING
685	SE74	TUPE BHAGYASHREE KASHINATH NISHA [CBSE]	ELECTRICAL ENGINEERING
686	SE75	UBHARE SHREYA SANJAY	ELECTRICAL ENGINEERING
687	SE76	VAGHARE SWAGAT MANOHAR	ELECTRICAL ENGINEERING
688	SE77	VARTAK AKASH KISHOR PRAMILA	ELECTRICAL ENGINEERING
689	SE78	WADAL PARAS DATTATREY	ELECTRICAL ENGINEERING
690	SE79	WASAVE SURAJ BHIMA	ELECTRICAL ENGINEERING
691	TE01	AMBAVANE AMRUTA MANOJ	ELECTRICAL ENGINEERING
692	TE02	ANDHARE SHUBHAM DEVENDRA	ELECTRICAL ENGINEERING
693	TE03	AWASKAR ROSHAN HIRAMAN	ELECTRICAL ENGINEERING
694	TE04	BAILMARE SAMIDHA RAVINDRA	ELECTRICAL ENGINEERING
695	TE05	BHOIR NARAYAN PUNDLIK	ELECTRICAL ENGINEERING
696	TE06	BHOIR PRATHAMESH PARSHURAM	ELECTRICAL ENGINEERING
697	TE07	BHOIR SHIVANI MAHESH	ELECTRICAL ENGINEERING
698	TE08	BHOPI NIKHIL BHAGVAN	ELECTRICAL ENGINEERING

TRUE COPY

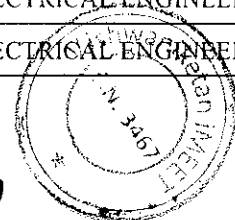
[Signature]
Principal
Vishwanandan's (i MEET)



699	TE09	BHOWATE PRANALI	ELECTRICAL ENGINEERING
700	TE10	BIDRE PRASAD DILIP	ELECTRICAL ENGINEERING
701	TE11	CHAVAN AJAY SHIVAJI	ELECTRICAL ENGINEERING
702	TE12	DALVI RUSHIKESH NARESH	ELECTRICAL ENGINEERING
703	TE13	DESHMUKH VAIBHAV HARISHCHANDRA	ELECTRICAL ENGINEERING
704	TE14	DHAYAGU DE KUNAL RAVINDRA	ELECTRICAL ENGINEERING
705	TE15	DHUMAL MANOHAR ASHOK	ELECTRICAL ENGINEERING
706	TE16	DUBE RASHIKA VILAS	ELECTRICAL ENGINEERING
707	TE17	FOFERKAR PRANAY	ELECTRICAL ENGINEERING
708	TE18	GADE PRATIK SAVLARAM	ELECTRICAL ENGINEERING
709	TE19	GAIKWAD SUMIT SHAHAJI	ELECTRICAL ENGINEERING
710	TE20	GAMBHIR SAURABH VISHWAS	ELECTRICAL ENGINEERING
711	TE21	GHARGE ARCHANA	ELECTRICAL ENGINEERING
712	TE22	GIRI ARATI	ELECTRICAL ENGINEERING
713	TE23	JAITU ADITYA	ELECTRICAL ENGINEERING
714	TE24	JOSHI PRATIK	ELECTRICAL ENGINEERING
715	TE25	JOSHI RAHUL SUDHAKAR	ELECTRICAL ENGINEERING
716	TE26	KANGE DIPTI LAXMAN SANGEETA	ELECTRICAL ENGINEERING
717	TE27	KARDE YUVRAJ BHALCHANDRA	ELECTRICAL ENGINEERING
718	TE28	KOLEKAR BHAGYASHREE HARI	ELECTRICAL ENGINEERING
719	TE29	KUSHWAHA AAKASH	ELECTRICAL ENGINEERING
720	TE30	LOHAR AMISH VIJAY MANISHA	ELECTRICAL ENGINEERING
721	TE31	LOLE NIKITA SURESH	ELECTRICAL ENGINEERING
722	TE32	MAHATO KRISHNA	ELECTRICAL ENGINEERING
723	TE33	MANE DEVYANI SANJAY	ELECTRICAL ENGINEERING
724	TE34	MANER ALPESH ASHOK	ELECTRICAL ENGINEERING
725	TE35	MHASKE AKASH MHATARBA	ELECTRICAL ENGINEERING
726	TE36	MHATRE HARSHAL DATTATRAY	ELECTRICAL ENGINEERING
727	TE37	MHATRE RUCHITA LASHINATH	ELECTRICAL ENGINEERING
728	TE38	MHATRE SAGAR KASHINATH	ELECTRICAL ENGINEERING
729	TE39	MISHRA KARUNANAND MANOJ R.	ELECTRICAL ENGINEERING
730	TE40	MOKAL DAKSHATA DASHARATH	ELECTRICAL ENGINEERING
731	TE41	MOKAL VAISHNAVI VISHWANATH	ELECTRICAL ENGINEERING
732	TE42	MORE SUMIT SUNIL	ELECTRICAL ENGINEERING
733	TE43	MUNDHE MAYUR BHIM	ELECTRICAL ENGINEERING
734	TE44	OVHAL PRATIK PRABHAKAR	ELECTRICAL ENGINEERING
735	TE45	PANDIT SHREELESH SHARAD	ELECTRICAL ENGINEERING

TRUE COPY

JKP
Principal

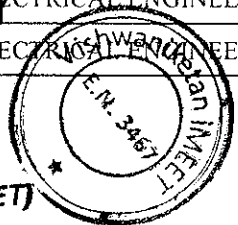

Vishwaniketan's (i MEET)

736	TE46	PATIL ABHILASH CHANDRAKANT	ELECTRICAL ENGINEERING
737	TE47	PATIL ARPITA SHRIDIHAR	ELECTRICAL ENGINEERING
738	TE48	PATIL JAYESH SANJAY	ELECTRICAL ENGINEERING
739	TE49	PATIL NIKET	ELECTRICAL ENGINEERING
740	TE50	PATIL PRADNYA PANDURANG	ELECTRICAL ENGINEERING
741	TE51	PATIL PRAJYOTI LAXMAN	ELECTRICAL ENGINEERING
742	TE52	PATIL PRITESH PRABHAKAR	ELECTRICAL ENGINEERING
743	TE53	PATIL RUSHIKESH BABAN	ELECTRICAL ENGINEERING
744	TE54	PATIL SAHIL SOPAN DHARTI	ELECTRICAL ENGINEERING
745	TE55	PATIL SUMIT SANJAY NEHA	ELECTRICAL ENGINEERING
746	TE56	PATIL TEJAS CHANDRAKANT	ELECTRICAL ENGINEERING
747	TE57	PAWAR MANGESH ANKUSH	ELECTRICAL ENGINEERING
748	TE58	PAWAR NITISH BHIMRAO	ELECTRICAL ENGINEERING
749	TE59	PHADKE AMEYA ANAND AARATI	ELECTRICAL ENGINEERING
750	TE60	PINGALE JAY KASHINATH	ELECTRICAL ENGINEERING
751	TE61	PINGALE PRIYANKA KRUSHNA DEEPA	ELECTRICAL ENGINEERING
752	TE62	RAJHANS ANKIT RAVINDRA	ELECTRICAL ENGINEERING
753	TE63	RAUT SAIRAJ SUNIL	ELECTRICAL ENGINEERING
754	TE64	SAKPAL ONKAR PRADEEP	ELECTRICAL ENGINEERING
755	TE65	SATRE HARSHADA VIJAY	ELECTRICAL ENGINEERING
756	TE66	SAWANT AMEY	ELECTRICAL ENGINEERING
757	TE67	SHINDE MILIND KISHOR ALKA	ELECTRICAL ENGINEERING
758	TE68	SHINGRUT ROSHANI SANJAY	ELECTRICAL ENGINEERING
759	TE69	SHIRKE SHUBHAM SUDESH	ELECTRICAL ENGINEERING
760	TE70	SINGH YASH SHRAVAN	ELECTRICAL ENGINEERING
761	TE71	SUTAR NIKHIL KISHOR	ELECTRICAL ENGINEERING
762	TE72	TAYDE NILESH PUNJAJI NIMALA	ELECTRICAL ENGINEERING
763	TE73	THAKUR AKHIL	ELECTRICAL ENGINEERING
764	TE74	THOMBARE PRIYANKA	ELECTRICAL ENGINEERING
765	TE75	TIWARI SAURABH RAGHAVENDRA	ELECTRICAL ENGINEERING
766	TE76	TUPE OMKAR ASHOK	ELECTRICAL ENGINEERING
767	TE77	UBHARE ROHIT RAMDAS	ELECTRICAL ENGINEERING
768	TE78	WADE SANKET RAJENDRA	ELECTRICAL ENGINEERING
769	TE79	YADAV AWDHESH KUMAR SEVA	ELECTRICAL ENGINEERING
770	BE01	ADOLE APURVA SUKHDEV SANJIVANI	ELECTRICAL ENGINEERING
771	BE02	AWARI ANIL	ELECTRICAL ENGINEERING
772	BE03	BAKKAR NIMISH BALKRISHNA NISHIGANDHA	ELECTRICAL ENGINEERING

TRUE COPY

PKP
 Vishwaniketan's (i MEET)



773	BE04	BARAD YOGESH SUNIL BHARTI	ELECTRICAL ENGINEERING
774	BE05	BHATKAR PRATHAMESH DILIP DIPIKA	ELECTRICAL ENGINEERING
775	BE06	BHAYE BHUSHAN ARVIND URMILA	ELECTRICAL ENGINEERING
776	BE07	BHIDE SWANAND SHRIKANT MADHURA	ELECTRICAL ENGINEERING
777	BE08	BHISE ARJUN TUKARAM PRITI	ELECTRICAL ENGINEERING
778	BE09	BHOIR ASHUTOSH SHAMRAV SHILPA	ELECTRICAL ENGINEERING
779	BE10	BHOSALE UDAY SANJAY SANJIVANI	ELECTRICAL ENGINEERING
780	BE11	CHANDORKAR KUNAL MUKUND MEENA	ELECTRICAL ENGINEERING
781	BE12	DALVI SANKET SANTOSH SUJATA	ELECTRICAL ENGINEERING
782	BE13	DALVI VIRAJ SANTOSH SHARADA	ELECTRICAL ENGINEERING
783	BE14	DESAI SURAJ VITTHAL SAVITA	ELECTRICAL ENGINEERING
784	BE15	DESALE SUMIT ARUN	ELECTRICAL ENGINEERING
785	BE16	DESHMUKH SAURABH DNYANESHWAR RANJANA	ELECTRICAL ENGINEERING
786	BE17	DESHMUKH SHILPA SHRIKANT ALAKA	ELECTRICAL ENGINEERING
787	BE18	DOIPHODE PANKAJ BHIM POURNIMA	ELECTRICAL ENGINEERING
788	BE19	GAIKWAD VAIBHAV SIDDHARTH SUNITA	ELECTRICAL ENGINEERING
789	BE20	GHARAT DAMINI SANTOSH BHARTI	ELECTRICAL ENGINEERING
790	BE21	GHARATKAR SIDDESH VIKAS SANJIVANI	ELECTRICAL ENGINEERING
791	BE22	GHAYTADAK SUMIT SHAMRAO SUJATA	ELECTRICAL ENGINEERING
792	BE23	GHUDE HARSHAL MANOHAR SANGITA	ELECTRICAL ENGINEERING
793	BE24	GURAV PRANAY PRASHANT	ELECTRICAL ENGINEERING
794	BE25	INCHANALKAR POOJA BAPUSAHEB	ELECTRICAL ENGINEERING
795	BE26	JADHAV RAJKUMAR YUVRAJ MANGALA	ELECTRICAL ENGINEERING
796	BE27	JADHAV SURAJ DHONDURAM PRIYANKA	ELECTRICAL ENGINEERING
797	BE28	JAMDAR VISHAL DHONDIRAM JANNABAI	ELECTRICAL ENGINEERING
798	BE29	KADAM ASHWINKUMAR ASHOK SWATI	ELECTRICAL ENGINEERING
799	BE30	KAKAD SAGAR SUBHASH PUSHPA	ELECTRICAL ENGINEERING
800	BE31	KOLI SONALI SUNIL SUREKHA	ELECTRICAL ENGINEERING
801	BE32	KOLI SUMIT RAJU DHANWANTI	ELECTRICAL ENGINEERING
802	BE33	KONDUSKAR CHANDRAKANT	ELECTRICAL ENGINEERING
803	BE34	LOHOT HRISHIKESH BALU LALITA	ELECTRICAL ENGINEERING
804	BE35	MAHIMKAR ABHISHEK SAMEER	ELECTRICAL ENGINEERING
805	BE36	MAITY SUDEEPA SUBODH DEEPA	ELECTRICAL ENGINEERING
806	BE37	MHATRE CHETAN KIRAN DYAMANTI	ELECTRICAL ENGINEERING
807	BE38	MHATRE MANDAR RAMAKANT RESHMA	ELECTRICAL ENGINEERING
808	BE39	MHATRE MOHANISH	ELECTRICAL ENGINEERING
809	BE40	MIRGAL PARESH MANOHAR MADHURI	ELECTRICAL ENGINEERING

TRUE COPY

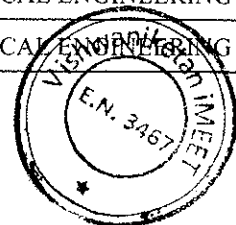

810	BE41	MORF HARISH ANKUSH LATA	ELECTRICAL ENGINEERING
811	BE42	MULIK MAYUR KRISHNARAO BHARATI	ELECTRICAL ENGINEERING
812	BE43	NAIR KRISHNAPRASAD	ELECTRICAL ENGINEERING
813	BE44	NARSINGH APURV DHARMENDRA	ELECTRICAL ENGINEERING
814	BE45	PANDEY GAURAV BIRENDRA PUSHIPA	ELECTRICAL ENGINEERING
815	BE46	PANDEY ROUSHAN VIJAY RANJU	ELECTRICAL ENGINEERING
816	BE47	PANSANDE SWAPNALI CHANDRASHEKHAR	ELECTRICAL ENGINEERING
817	BE48	PARINGE NITESH BHAGA SUNITA	ELECTRICAL ENGINEERING
818	BE49	PARULEKAR ADITYA SURENDRA SUVARNA	ELECTRICAL ENGINEERING
819	BE50	PATIL AJINKYA DAYANAND MANISHA	ELECTRICAL ENGINEERING
820	BE51	PATIL AKSHAY JANARDAN ANITA	ELECTRICAL ENGINEERING
821	BE52	PATIL ANKITA GANPAT NITA	ELECTRICAL ENGINEERING
822	BE53	PATIL CHETNA BHAGWAN ARCHANA	ELECTRICAL ENGINEERING
823	BE54	PATIL GOKUL RAMESH NANDA	ELECTRICAL ENGINEERING
824	BE55	PATIL HARSHAL KAMLESH RUPALI	ELECTRICAL ENGINEERING
825	BE56	PATIL MINAL MACHHINDRANATH	ELECTRICAL ENGINEERING
826	BE57	PATIL VINAYAK DHONDIBA GEETA	ELECTRICAL ENGINEERING
827	BE58	PAWAR SHUBHAM KASHINATH VANITA	ELECTRICAL ENGINEERING
828	BE59	PENKAR AMIR REFAYAL SARA	ELECTRICAL ENGINEERING
829	BE60	RAUT VISHAKHA PRABHAKAR PRAJAKTA	ELECTRICAL ENGINEERING
830	BE61	SALUNKE VINAYAK TANAJI NANDA	ELECTRICAL ENGINEERING
831	BE62	SALVE DIKSHA SHASHIKANT RAJANI	ELECTRICAL ENGINEERING
832	BE63	SANKLECHA MAHIL ARAVIND KAVITA	ELECTRICAL ENGINEERING
833	BE64	SHELAR SHUBHAM SANTOSH MANGAL	ELECTRICAL ENGINEERING
834	BE65	SHELKE NILESH VILAS GANGUBAI	ELECTRICAL ENGINEERING
835	BE66	SHINDE AKSHAY DIPAK MANISHA	ELECTRICAL ENGINEERING
836	BE67	SINGH AJEET KUMAR SATISH SUMAN	ELECTRICAL ENGINEERING
837	BE68	TAMBAT SAGAR SHANTARAM VIDYA	ELECTRICAL ENGINEERING
838	BE69	TARU JAYESH NAMDEV NAMRATA	ELECTRICAL ENGINEERING
839	BE70	TAYADE SAGAR SHASHIKANT UJJAWALA	ELECTRICAL ENGINEERING
840	BE71	THAKUR KISHORI SHRIKRISHNA KANCHAN	ELECTRICAL ENGINEERING
841	BE72	TODANKAR KRUNAL CHANDRAKANT SAMIDHA	ELECTRICAL ENGINEERING
842	BE73	WADKE HARSHAL RAMESH RASHMI	ELECTRICAL ENGINEERING
843	BE74	WAGH ANIKET BALU NEETA	ELECTRICAL ENGINEERING
844	BE75	WATWE AKSHAY SUNIL SHALINI	ELECTRICAL ENGINEERING
845	BE76	ZIMBAL KOMAL VASANT SUVARNA	ELECTRICAL ENGINEERING
846	SE1	AHIRE ASHISH NITIN	ELECTRONICS AND TELECOMMUNI

TRUE COPY

Principal
Vishwaniketan's (I MEET)



847	SE2	BHOPI MAYURESH MOHAN	ELECTRONICS AND TELECOMMUNI
848	SE3	BHOSALE DHANASHREE MANOHAR	ELECTRONICS AND TELECOMMUNI
849	SE4	BHOSALE KIRAN SANJEEV	ELECTRONICS AND TELECOMMUNI
850	SE5	DESHMUKH RUTUJA KISHOR	ELECTRONICS AND TELECOMMUNI
851	SE6	DESHMUKH SHWETA SUNIL	ELECTRONICS AND TELECOMMUNI
852	SE7	GHARAT PRAJAKTA DATTATRAY	ELECTRONICS AND TELECOMMUNI
853	SE8	KUMBHAR KUNAL SHASHIKANT	ELECTRONICS AND TELECOMMUNI
854	SE9	LOTE MANSI VINAYAK	ELECTRONICS AND TELECOMMUNI
855	SE10	MAAN DAKSH	ELECTRONICS AND TELECOMMUNI
856	SE11	MANE PRATIKSHA AJIT	ELECTRONICS AND TELECOMMUNI
857	SE12	MHATRE RUPALI SHAILESH	ELECTRONICS AND TELECOMMUNI
858	SE13	MHATRE SWATI SUNIL	ELECTRONICS AND TELECOMMUNI
859	SE14	MOKAL SWAGAT ANIL	ELECTRONICS AND TELECOMMUNI
860	SE15	MORE NIHAR SANDEEP	ELECTRONICS AND TELECOMMUNI
861	SE16	NEMADE GAURAV SANTOSH	ELECTRONICS AND TELECOMMUNI
862	SE17	PATIL JAYDIP PRAKASH	ELECTRONICS AND TELECOMMUNI
863	SE18	PATIL NIKITA BABASAHEB	ELECTRONICS AND TELECOMMUNI
864	SE19	PATIL VINEET VASANT	ELECTRONICS AND TELECOMMUNI
865	SE20	PAWAR SANKET BAPU	ELECTRONICS AND TELECOMMUNI
866	SE21	SHAHANE SAKSHI ATUL	ELECTRONICS AND TELECOMMUNI
867	SE22	SUTAR SHARVARI KISHOR	ELECTRONICS AND TELECOMMUNI
868	SE23	THAKARE TEJASVI GANESH	ELECTRONICS AND TELECOMMUNI
869	SE24	THOMBARE SHRADDHA GAJENDRA	ELECTRONICS AND TELECOMMUNI
870	SE25	VAREKAR MAYURI BHAGAVATRAO	ELECTRONICS AND TELECOMMUNI
871	SE26	YAGNIK RIDDHI MUKUNDBHAI	ELECTRONICS AND TELECOMMUNI
872	SE27	PATIL PIYUSH BALIRAM	ELECTRONICS AND TELECOMMUNI
873	SE28	BHALERAO SHUBHAM SANJAY	ELECTRONICS AND TELECOMMUNI
874	SE29	DASWADKAR MILIND JANARDAN	ELECTRONICS AND TELECOMMUNI
875	SE30	JAMBHALE PRERANA DINKAR	ELECTRONICS AND TELECOMMUNI
876	SE31	PANDIT SANDESH PRAKASH	ELECTRONICS AND TELECOMMUNI
877	SE32	PATIL SHARAYU SHANKAR	ELECTRONICS AND TELECOMMUNI
878	TE 01	AWASKAR SAYALI BHARAT	ELECTRONICS AND TELECOMMUNI
879	TE 02	BAMBORI PRATIKSHA CHETANKUMAR	ELECTRONICS AND TELECOMMUNI
880	TE 03	BANGAR SHUBHAM VIVEKANAND	ELECTRONICS AND TELECOMMUNI
881	TE 04	BHOSALE ANIKET GANPAT	ELECTRONICS AND TELECOMMUNI
882	TE 05	BODEKAR ARATI BALU	ELECTRONICS AND TELECOMMUNI
883	TE 06	DESAI HRUSHIKESH RAJENDRA	ELECTRONICS AND TELECOMMUNI

TRUE COPY

Principal
Vishwaniketan's (I MEET)

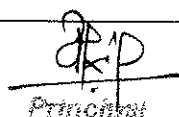

884	TE 07	DESAI PRIYANKA ARUN	ELECTRONICS AND TELI COMMUNI
885	TE 08	GHARAT AJIT ARUN	ELECTRONICS AND TELI COMMUNI
886	TE 09	GIRI SAKSHI GAJANAN	ELECTRONICS AND TELECOMMUNI
887	TE 10	HALDAR SOURADEEP	ELECTRONICS AND TELECOMMUNI
888	TE 11	ITHAPE PRIYANKA RAJARAM	ELECTRONICS AND TELECOMMUNI
889	TE 12	JAMBHALE PRERANA DINKAR	ELECTRONICS AND TELECOMMUNI
890	TE 13	KHARADE SANKET SUNIL	ELECTRONICS AND TELECOMMUNI
891	TE 14	KHOT AKSHAY VISHNU	ELECTRONICS AND TELECOMMUNI
892	TE 15	MALI PRANJALI VIJAYKUMAR	ELECTRONICS AND TELECOMMUNI
893	TE 16	MANDAVKAR SOURABH SANJAY	ELECTRONICS AND TELECOMMUNI
894	TE 17	MHATRE PRANALI CHANDRAKANT	ELECTRONICS AND TELECOMMUNI
895	TE 18	MHATRE SUVIDHA SAROJKUMAR	ELECTRONICS AND TELECOMMUNI
896	TE 19	MHATRE VIKRANTI MANGESH	ELECTRONICS AND TELECOMMUNI
897	TE 20	MISHRA KESHAV HARISH	ELECTRONICS AND TELECOMMUNI
898	TE 21	PANDIT SANDESH PRAKASH	ELECTRONICS AND TELECOMMUNI
899	TE 22	PATIL NIDHI VINIT	ELECTRONICS AND TELECOMMUNI
900	TE 23	PATIL SHARAYU SHANKAR	ELECTRONICS AND TELECOMMUNI
901	TE 24	SALVEKAR PRATIKSHA PRASHANT	ELECTRONICS AND TELECOMMUNI
902	TE 25	SHELKE TITIKSHA CHANGDEV	ELECTRONICS AND TELECOMMUNI
903	TE 26	SHILIMKAR PRATIKSHA MANOHAR	ELECTRONICS AND TELECOMMUNI
904	TE 27	SHINDE MINAL MAHESH	ELECTRONICS AND TELECOMMUNI
905	TE 28	SHIVALE MINAL SHIVAJI	ELECTRONICS AND TELECOMMUNI
906	TE 29	UGALE PRATIKSHA ANIL	ELECTRONICS AND TELECOMMUNI
907	TE 30	VALMIK ERESHWARI MALLESH	ELECTRONICS AND TELECOMMUNI
908	TE 31	WALGUDE APEKSHA VIKAS	ELECTRONICS AND TELECOMMUNI
909	TE 32	WANI SIMRAN KRISHNANATH	ELECTRONICS AND TELECOMMUNI
910	TE 33	YADAV GEETA BALKISHAN	ELECTRONICS AND TELECOMMUNI
911	BE 01	BHILARE KIRAN MUGUT	ELECTRONICS AND TELECOMMUNI
912	BE 02	BHOSALE POONAM RAMESH	ELECTRONICS AND TELECOMMUNI
913	BE 03	CHOUGULE GURURAJ CHANDRASHEKHAR	ELECTRONICS AND TELECOMMUNI
914	BE 04	DESHMUKH VIRAJ RAJENDRA	ELECTRONICS AND TELECOMMUNI
915	BE 05	DESHPANDE PARTH MAKARAND	ELECTRONICS AND TELECOMMUNI
916	BE 06	DONGARE AKSHAY ROHIDAS	ELECTRONICS AND TELECOMMUNI
917	BE 07	DUBAL AJAY VISHNU	ELECTRONICS AND TELECOMMUNI
918	BE 08	DUKARE SANDESH ARUN	ELECTRONICS AND TELECOMMUNI
919	BE 09	GAUND SURAJ AJIT	ELECTRONICS AND TELECOMMUNI
920	BE 10	GOLE PRANALI ARJUN	ELECTRONICS AND TELECOMMUNI

Principal

Vishwaniketan's (i MEET)

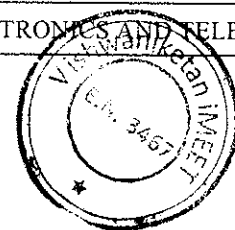

921	BE 11	GURAV JATIN MAHESH	ELECTRONICS AND TELECOMMUNI
922	BE 12	HARPUDE VRHUSHABH GAJANAN	ELECTRONICS AND TELECOMMUNI
923	BE 13	ISHWARE TUSHAR ARVIND	ELECTRONICS AND TELECOMMUNI
924	BE 14	JANGAM ABHISHEK SHRIKANT	ELECTRONICS AND TELECOMMUNI
925	BE 15	JOSHI TANMAY VASANT	ELECTRONICS AND TELECOMMUNI
926	BE 16	KADAM DIPASHRI DILIP	ELECTRONICS AND TELECOMMUNI
927	BE 17	KADU BHAkti VILAS	ELECTRONICS AND TELECOMMUNI
928	BE 18	KAVALE KUNAL ASHISH	ELECTRONICS AND TELECOMMUNI
929	BE 19	KOKAMBE KIRAN BABAN	ELECTRONICS AND TELECOMMUNI
930	BE 20	KONT ANUJ ANAND	ELECTRONICS AND TELECOMMUNI
931	BE 21	KURANE AARTI RAVINDRA	ELECTRONICS AND TELECOMMUNI
932	BE 22	MANDLEKAR ASAVARI ANIL	ELECTRONICS AND TELECOMMUNI
933	BE 23	MANE PUNAM JALINDAR	ELECTRONICS AND TELECOMMUNI
934	BE 24	MHATRE SUPRIYA CHANDRAKANT	ELECTRONICS AND TELECOMMUNI
935	BE 25	MHATRE VIKRANT DINANATH	ELECTRONICS AND TELECOMMUNI
936	BE 26	MISHRA NITIN AKHILESH	ELECTRONICS AND TELECOMMUNI
937	BE 27	MOKAL AKSHAY NAMDEV	ELECTRONICS AND TELECOMMUNI
938	BE 28	MOKASHI YASH PRASHANT	ELECTRONICS AND TELECOMMUNI
939	BE 29	MORE SURAJ SATISH	ELECTRONICS AND TELECOMMUNI
940	BE 30	MUKADAM SARVESH MAHENDRA	ELECTRONICS AND TELECOMMUNI
941	BE 31	NAIK RASHMITHA JAYANAND	ELECTRONICS AND TELECOMMUNI
942	BE 32	NIKAM DHANASHREE VILAS	ELECTRONICS AND TELECOMMUNI
943	BE 33	NIKAM SAGAR MADHUKAR	ELECTRONICS AND TELECOMMUNI
944	BE 34	PATIL ABHEET ARVIND	ELECTRONICS AND TELECOMMUNI
945	BE 35	PATIL ADITYA DEVIDAS	ELECTRONICS AND TELECOMMUNI
946	BE 36	PATIL NAMRATA VILAS	ELECTRONICS AND TELECOMMUNI
947	BE 37	PATIL PRIYANKA RAMCHANDRA	ELECTRONICS AND TELECOMMUNI
948	BE 38	PATIL TEJAS VILAS	ELECTRONICS AND TELECOMMUNI
949	BE 39	PAWAR JITESH CHAMPALAL	ELECTRONICS AND TELECOMMUNI
950	BE 40	PAWAR SAI GANESH	ELECTRONICS AND TELECOMMUNI
951	BE 41	RAJPURKAR PRATIKSHA KRUSHNA	ELECTRONICS AND TELECOMMUNI
952	BE 42	RATHOD POOJA NAMDEV	ELECTRONICS AND TELECOMMUNI
953	BE 43	SAHU JANKIDEVI SHIVPRASAD	ELECTRONICS AND TELECOMMUNI
954	BE 44	SHINDE SHWETA DILIPKUMAR	ELECTRONICS AND TELECOMMUNI
955	BE 45	SHINDE SURAJ SANJAY	ELECTRONICS AND TELECOMMUNI
956	BE 46	SHRIGIRI KARAN DATTATRAYA	ELECTRONICS AND TELECOMMUNI
957	BE 47	SHRIVASTAVA RISHAV ASHOK	ELECTRONICS AND TELECOMMUNI

TRUE COPY

[Signature]
Principal
Vishwaniketan's (i MEET)



958	BE 48	SHRIVASTAVA SAURABH RAJKUMAR	ELECTRONICS AND TELECOMMUNI
959	BE 49	SINGH ARJUN RAJIVLOCHAN	ELECTRONICS AND TELECOMMUNI
960	BE 50	THAKUR ROHAN LAXMAN	ELECTRONICS AND TELECOMMUNI
961	BE 51	WAIKAR SNEHAL PRABHAKAR	ELECTRONICS AND TELECOMMUNI
962	SEA01	ANDHALE ANIKET SAMPAT SARALA	MECHANICAL ENGINEERING
963	SEA02	ATKARI TEJAS SANJAY ARCHANA	MECHANICAL ENGINEERING
964	SEA03	BAGUL HARSHAL	MECHANICAL ENGINEERING
965	SEA04	BARUA ABHISHEK RANJIT	MECHANICAL ENGINEERING
966	SEA05	BARVE AKASH SATYVAN ASHWINI	MECHANICAL ENGINEERING
967	SEA06	BHAGAT AKSHAY ANANDKUMAR	MECHANICAL ENGINEERING
968	SEA07	BHAGAT TANUJ DINESH VIDYA	MECHANICAL ENGINEERING
969	SEA08	BHAWKE OMKAR BAJARANG SHUBHANGI	MECHANICAL ENGINEERING
970	SEA09	BHAYTANDEL ANIKET CHANDRAKANT	MECHANICAL ENGINEERING
971	SEA10	BHOIR ROHAN HEMANT	MECHANICAL ENGINEERING
972	SEA11	BHUSARI APURV VISHNU	MECHANICAL ENGINEERING
973	SEA12	CHANDEL SATEJSINGH MAHENDRASINGH RACHAN	MECHANICAL ENGINEERING
974	SEA13	CHANDORKAR SOHAM ATUL	MECHANICAL ENGINEERING
975	SEA14	CHAUDHARY HIMANSHU PRALHAD SHEETAL	MECHANICAL ENGINEERING
976	SEA15	CHAVAN VISHWAJIT SATISH VRUSHALI	MECHANICAL ENGINEERING
977	SEA16	CHOUDHARY SURAJ KEDAR PRASAD SUDHAKUMAR	MECHANICAL ENGINEERING
978	SEA17	DALAVI KUNAL RAVINDRA	MECHANICAL ENGINEERING
979	SEA18	DALVI MAYURESH SUNIL MADHURI	MECHANICAL ENGINEERING
980	SEA19	DESHMUKH NIKHIL UDAY	MECHANICAL ENGINEERING
981	SEA20	DESHMUKH SAHIL DINESH	MECHANICAL ENGINEERING
982	SEA21	DESHMUKH SANKET SURESH NIRMALA	MECHANICAL ENGINEERING
983	SEA22	DHUMAL AKASH ARVIND	MECHANICAL ENGINEERING
984	SEA23	DOMBALE SANJEEVANI LALASAHEB NEELAM	MECHANICAL ENGINEERING
985	SEA24	DUDHBHATE SURAJ KHANDU KAMAL	MECHANICAL ENGINEERING
986	SEA25	FAKKE AKASH RAJENDRA	MECHANICAL ENGINEERING
987	SEA26	GAIKWAD JAY PRAFULL	MECHANICAL ENGINEERING
988	SEA27	GAIKWAD MRUNAL NARENDRA MALTI	MECHANICAL ENGINEERING
989	SEA28	GATARE SHARDUL SHEKHAR MINAL	MECHANICAL ENGINEERING
990	SEA29	GAVADE OMKAR SANTOSH RUPALI	MECHANICAL ENGINEERING
991	SEA30	GHADAGE UTKARSH MADHUKAR SUSHAMA	MECHANICAL ENGINEERING
992	SEA31	GHARAT ABHIJIT RAMCHANDRA MANDAKINI	MECHANICAL ENGINEERING
993	SEA32	GHARAT DIPTESH CHANDRAKANT VAISHALI	MECHANICAL ENGINEERING
994	SEA33	GHARAT JAY ANANT ASHWINI	MECHANICAL ENGINEERING

TRUE COPY

JAP

Principal

Vishwaniketan's (i MEET)

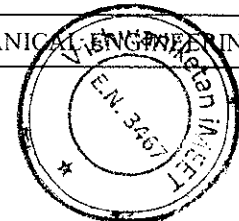

995	SEA34	GHARAT PUSHPAK RAJESH SUNITA	MECHANICAL ENGINEERING
996	SEA35	GHOLE DAKSHET SURESH SUCHITA	MECHANICAL ENGINEERING
997	SEA36	GOLIAR VIKAS	MECHANICAL ENGINEERING
998	SEA37	GUTTE KRISHNA	MECHANICAL ENGINEERING
999	SEA38	HEGISTE BHUSHAN SHRIKANT SHRADDHA	MECHANICAL ENGINEERING
1000	SEA39	INGALE ONKAR LAXMAN LATA	MECHANICAL ENGINEERING
1001	SEA40	JADHAV GAURAV CHHOTULAL MANJUSHA	MECHANICAL ENGINEERING
1002	SEA41	JADHAV ROHIT BAPU SANGITA	MECHANICAL ENGINEERING
1003	SEA42	JAIN SHUBHAM PARASMAIL RINA	MECHANICAL ENGINEERING
1004	SEA43	JAWALE RISHIKESH BHARAT	MECHANICAL ENGINEERING
1005	SEA44	JOSHI RUTIK PRABHAKAR PRATIKSHA	MECHANICAL ENGINEERING
1006	SEA45	KADU YASH JITENDRA POOJA	MECHANICAL ENGINEERING
1007	SEA46	KAMBLE SIDDHANT SANJAY SUREKHA	MECHANICAL ENGINEERING
1008	SEA47	KAMBLE SUMEDHI BALIRAM KALPANA	MECHANICAL ENGINEERING
1009	SEA48	KARKARE ANKIT RAMESH SMITA	MECHANICAL ENGINEERING
1010	SEA49	KATAKE KUNAL NANDKUMAR KARUNA	MECHANICAL ENGINEERING
1011	SEA50	KATE MOHAN DNYANDEV PUSHPA	MECHANICAL ENGINEERING
1012	SEA51	KHANDALE RAVINDRA BIRAPPA SHOBHA [TFWS]	MECHANICAL ENGINEERING
1013	SEA52	KURMI VAIBHAV SHAMBHU	MECHANICAL ENGINEERING
1014	SEA53	LAGDHIR MAYUR RAMJI HIRIBEN	MECHANICAL ENGINEERING
1015	SEA54	LANGI SAMIKSHA YOGESH	MECHANICAL ENGINEERING
1016	SEA55	LENDAVE SUYASH SIDDHESHWAR SANGEETA	MECHANICAL ENGINEERING
1017	SEA56	LOKHANDE SANKET RAJESH SNEHALATA	MECHANICAL ENGINEERING
1018	SEA57	MADHAVI SARVESH SANTOSH HEMLATA	MECHANICAL ENGINEERING
1019	SEA58	MAGAR OMKAR ROHIDAS	MECHANICAL ENGINEERING
1020	SEA59	MALI NIRAJ JIJABRAO PARUL	MECHANICAL ENGINEERING
1021	SEA60	MALI SAHIL SHARAD	MECHANICAL ENGINEERING
1022	SEA61	MALI VIRAJ RAJENDRA VIDYA	MECHANICAL ENGINEERING
1023	SEA62	MANDHARE PRANAY	MECHANICAL ENGINEERING
1024	SEA63	MANE NIKHIL SURESH MANISHA	MECHANICAL ENGINEERING
1025	SEA64	MHATRE KARAN MANOJ	MECHANICAL ENGINEERING
1026	SEA65	MHATRE KUNAL BALIRAM	MECHANICAL ENGINEERING
1027	SEA66	MHATRE KUNAL SHASHIKANT ROHINI	MECHANICAL ENGINEERING
1028	SEA67	MHATRE MRUNAL KRISHNA	MECHANICAL ENGINEERING
1029	SEA68	MHATRE NITESH MUKUND GEETA	MECHANICAL ENGINEERING
1030	SEA69	MHATRE PRATIK JANARDAN	MECHANICAL ENGINEERING
1031	SEA70	MOKAL NANDAN ANIL	MECHANICAL ENGINEERING

TRUE COPY

Principal

Principal
Vishwaniketan's (I MEET)

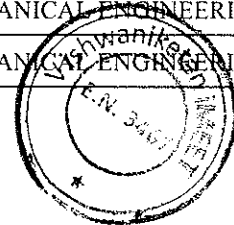

1032	SEA71	/SORATE AKSHATA ASHOK	MECHANICAL ENGINEERING
1033	SEA72	/MORE SONAL HARIBHAU NIRMALA	MECHANICAL ENGINEERING
1034	SEB01	MORE AJINKYA AMOL	MECHANICAL ENGINEERING
1035	SEB02	MORE OMKAR	MECHANICAL ENGINEERING
1036	SEB04	NADKAR SHUBHAM RAMESH	MECHANICAL ENGINEERING
1037	SEB05	NAGOTKAR AKSHAY ANIL ASHWINI	MECHANICAL ENGINEERING
1038	SEB06	NAIK SAHIL UMESH	MECHANICAL ENGINEERING
1039	SEB07	NANDE ATHARVA MANOJ VAIBHAVI [TFWS]	MECHANICAL ENGINEERING
1040	SEB08	NANGARE RAHUL JITENDRA	MECHANICAL ENGINEERING
1041	SEB09	NANGARE SHIVAM RAMDAS	MECHANICAL ENGINEERING
1042	SEB10	NANGARE YOGESH KUNDALIK CHHAYA	MECHANICAL ENGINEERING
1043	SEB11	NARVEKAR SHREEMAY SANJAY SUDHA	MECHANICAL ENGINEERING
1044	SEB12	PANDEY PIYUSH RAMSAJIVAN SUMAN	MECHANICAL ENGINEERING
1045	SEB13	PANDEY SHASHANK ARUNKUMAR PHOOLKUMARI	MECHANICAL ENGINEERING
1046	SEB14	PATIL ADITYA KANTILAL ANITA	MECHANICAL ENGINEERING
1047	SEB15	PATIL BHAVESH HEMANT	MECHANICAL ENGINEERING
1048	SEB16	PATIL DEVENDRA DATTARAM	MECHANICAL ENGINEERING
1049	SEB17	PATIL HRUTIK KISHOR	MECHANICAL ENGINEERING
1050	SEB18	PATIL MANISH ANIL VIJAYA [TFWS]	MECHANICAL ENGINEERING
1051	SEB19	PATIL MANTHAN SANTOSH	MECHANICAL ENGINEERING
1052	SEB20	PATIL NIKHIL RAJENDRA ASHA	MECHANICAL ENGINEERING
1053	SEB21	PATIL PRASHANT SHESHERAO	MECHANICAL ENGINEERING
1054	SEB22	PATIL PRATHAMESH PRADEEP	MECHANICAL ENGINEERING
1055	SEB23	PATIL TANMAY REVNAATH	MECHANICAL ENGINEERING
1056	SEB24	PATIL TUSHMESH LAXMAN VAISHALI	MECHANICAL ENGINEERING
1057	SEB25	PATIL VINIT ABHUMANJU MANISHA	MECHANICAL ENGINEERING
1058	SEB26	PATIL VINIT ANIL VINAYKI	MECHANICAL ENGINEERING
1059	SEB27	PATLE KSHITIJ JAIKRISHNA KALPANA	MECHANICAL ENGINEERING
1060	SEB28	PAWAR AKASH ANIL APARNA	MECHANICAL ENGINEERING
1061	SEB29	PAWAR DILIP ARUN	MECHANICAL ENGINEERING
1062	SEB30	PAWAR KUNAL MOHAN RUPA	MECHANICAL ENGINEERING
1063	SEB31	PAWAR SHUBHAM VISHAL MANGAL	MECHANICAL ENGINEERING
1064	SEB32	PINJARI PRAJYOT NARAYAN	MECHANICAL ENGINEERING
1065	SEB33	PITKAR AJIT VIVEK ARCHANA	MECHANICAL ENGINEERING
1066	SEB34	POL TUSHAR YUVRAJ SAVITA	MECHANICAL ENGINEERING
1067	SEB35	RANE OMKAR ANIL	MECHANICAL ENGINEERING
1068	SEB36	RODE ONKAR HANUMANT MADHUR	MECHANICAL ENGINEERING

TRUE COPY

[Signature]

Principal

Vishwaniketan's (I MEET)

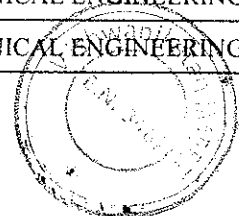

1069	SEB37	SALAVI SAURABH SANDIP SANJANA	MECHANICAL ENGINEERING
1070	SEB38	SALE SHREYAS SANJAY	MECHANICAL ENGINEERING
1071	SEB39	SALUNKE ROHIT NARAYAN SAVITA	MECHANICAL ENGINEERING
1072	SEB40	SAMEL NISHANT MINAL CHETNA	MECHANICAL ENGINEERING
1073	SEB41	SARDAL RUTVIK ARUN	MECHANICAL ENGINEERING
1074	SEB42	SAWANT ADITYA AVINASH	MECHANICAL ENGINEERING
1075	SEB43	SAWANT SAURABH SUBHASH AARTI	MECHANICAL ENGINEERING
1076	SEB44	SHAIKH SAMIR JAMIL	MECHANICAL ENGINEERING
1077	SEB45	SHELKE RUSHIKESH DATTARAM RATAN	MECHANICAL ENGINEERING
1078	SEB46	SHELKE TUSHAR VILAS	MECHANICAL ENGINEERING
1079	SEB47	SHENDE SAGAR SOPAN SAVITA	MECHANICAL ENGINEERING
1080	SEB48	SHERKAR SHUBHAM SAMBHAJI ASHA	MECHANICAL ENGINEERING
1081	SEB49	SHINDE DARSHAN BHARAT NILIMA	MECHANICAL ENGINEERING
1082	SEB50	SHINDE PRATHMESH SURESH ANAGHA	MECHANICAL ENGINEERING
1083	SEB51	SHINDE ROHIT RAMCHANDRA HARSHAADA	MECHANICAL ENGINEERING
1084	SEB52	SHINDE SARVESH TULSHIDAS	MECHANICAL ENGINEERING
1085	SEB53	SHIRKE MIHIR RAJENDRA NUTAN	MECHANICAL ENGINEERING
1086	SEB54	SHIRKE SIDDHESH BHARAT LATA	MECHANICAL ENGINEERING
1087	SEB55	SINGH ANKIT SARVESH NEELAM	MECHANICAL ENGINEERING
1088	SEB56	SINGH RAGHVENDRA ARUN INDU	MECHANICAL ENGINEERING
1089	SEB57	SINGH SAHIL PRATAP SUNITA	MECHANICAL ENGINEERING
1090	SEB59	SUPE LOKESH	MECHANICAL ENGINEERING
1091	SEB60	TANDEL AMEY ANANT	MECHANICAL ENGINEERING
1092	SEB61	THAKUR PRITESH JEEVAN SNEHA	MECHANICAL ENGINEERING
1093	SEB62	TODKAR SURAJ TANAJI SANGEETA	MECHANICAL ENGINEERING
1094	SEB63	UGALE VAIBHAV	MECHANICAL ENGINEERING
1095	SEB64	VASHIKAR RUSHABH RAJESH RHUJULA	MECHANICAL ENGINEERING
1096	SEB65	VERMA NAGENDRA BABULAL ARCHANA	MECHANICAL ENGINEERING
1097	SEB66	VISHWAKARMA SOURABH DWIPCHAND URMILA	MECHANICAL ENGINEERING
1098	SEB67	VITKAR ATHARVA PRASAD SWATI	MECHANICAL ENGINEERING
1099	SEB68	WAGHE TANMAY ANIL ADITI	MECHANICAL ENGINEERING
1100	SEB69	WAIRAGADE MAHESH PRABHAKAR RAJNI [TFWS]	MECHANICAL ENGINEERING
1101	SEB70	ZORE CHANDU BABU	MECHANICAL ENGINEERING
1102	TEA01	ADATE RAHUL CHANDRAKANT SEEMA	MECHANICAL ENGINEERING
1103	TEA02	ATHAWALE HRISHIKESH SUNIL VIDYA	MECHANICAL ENGINEERING
1104	TEA03	BALMIKI RACHANA SURAJ POONAM	MECHANICAL ENGINEERING
1105	TEA04	BAWASKAR SIMRAN SUNIL SMITA	MECHANICAL ENGINEERING

TRUE COPY

AKP

Principal
Vishwanetan's



1106	TEA05	BHOIR SHUBHAM PRAKASH ARCHANA	MECHANICAL ENGINEERING
1107	TEA06	BHOSALE MAYURESH DILIP KANCHAN	MECHANICAL ENGINEERING
1108	TEA07	CHAVAN PRATIK SUNIL SNEHAL	MECHANICAL ENGINEERING
1109	TEA08	CHAVAN SAMBHAJI SHIVAJI SANGEETA	MECHANICAL ENGINEERING
1110	TEA09	DABIHANE JAGDISH PANDURANG RANJANA	MECHANICAL ENGINEERING
1111	TEA10	DESHMUKH DARSHAN NILKANTHRAO	MECHANICAL ENGINEERING
1112	TEA11	DESHMUKH KALPESH SURESH VANDANA	MECHANICAL ENGINEERING
1113	TEA12	DESHIPANDE YOGIRAJ MANISH SARITA	MECHANICAL ENGINEERING
1114	TEA13	DHOPTTE VIDYADHAR ARUNKUMAR SEEMA	MECHANICAL ENGINEERING
1115	TEA14	DOIPHODE AKASH ARJUN VAISHALI	MECHANICAL ENGINEERING
1116	TEA15	GAIKWAD CHETAN SAUDAGAR SUREKHA	MECHANICAL ENGINEERING
1117	TEA16	GAIKWAD PRATIK PRADIP PRADNYA	MECHANICAL ENGINEERING
1118	TEA17	GAMARE SAURABH SATISH SACHITA	MECHANICAL ENGINEERING
1119	TEA18	GHARAT UTKARSH DHARMENDRA SARITA	MECHANICAL ENGINEERING
1120	TEA19	GORDE PRASHANT DASHARATH	MECHANICAL ENGINEERING
1121	TEA20	GURAV NIKHIL MAHADEV	MECHANICAL ENGINEERING
1122	TEA21	HAWARE HRUSHIKESH AVINASH	MECHANICAL ENGINEERING
1123	TEA22	JADHAV MAYUR JAGDISH	MECHANICAL ENGINEERING
1124	TEA23	KADAM SURAJ SUHAS	MECHANICAL ENGINEERING
1125	TEA24	KAMBLE RUSHIKESH RAMESH	MECHANICAL ENGINEERING
1126	TEA25	KHEDKAR PRANAL RAJESH	MECHANICAL ENGINEERING
1127	TEA26	KOLI OMKAR CHANDRAKANT	MECHANICAL ENGINEERING
1128	TEA27	MAHADIK ANIKET BALIRAM	MECHANICAL ENGINEERING
1129	TEA28	MALI RUSHIKESH RAVINDRA	MECHANICAL ENGINEERING
1130	TEA29	MALIEKAL JITHIN JOSE SHINY	MECHANICAL ENGINEERING
1131	TEA30	MALUSARE SNEHA VIJAY	MECHANICAL ENGINEERING
1132	TEA31	MANDHARE PRATIK PRAMOD	MECHANICAL ENGINEERING
1133	TEA32	MESTRI PRASAD RAJENDRA	MECHANICAL ENGINEERING
1134	TEA33	MHATRE JAYESH DINANATH	MECHANICAL ENGINEERING
1135	TEA34	MHATRE RUSHABH BALIRAM	MECHANICAL ENGINEERING
1136	TEA35	MHATRE SANKET SUBHASH	MECHANICAL ENGINEERING
1137	TEA36	MHATRE SNEHA BHARAT	MECHANICAL ENGINEERING
1138	TEA37	MOHITE AJINKYA RAMCHANDRA SUJATA	MECHANICAL ENGINEERING
1139	TEA38	MOJAR SANKET MAHENDRA SMITA	MECHANICAL ENGINEERING
1140	TEA39	MONDKAR SANDEEP JAGDISH	MECHANICAL ENGINEERING
1141	TEA40	NAIKWADE MITHLESHA MOTILAL	MECHANICAL ENGINEERING
1142	TEA41	NIVETKAR YASH DINESH SANTOSHI	MECHANICAL ENGINEERING

TRUE COPY

[Handwritten Signature]

Principal

Vishwanath's MEET

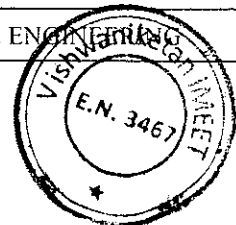

1143	TEA42	OWAL HIRUTVIK PANDURANG VANDANA	MECHANICAL ENGINEERING
1144	TEA43	PAKHARE ADITYA KISHOR MANGAL	MECHANICAL ENGINEERING
1145	TEA44	PALASKAR VISHAL AJAY SUJATA	MECHANICAL ENGINEERING
1146	TEA45	PATARE SWAPNIL PRAMOD SHOBHA	MECHANICAL ENGINEERING
1147	TEA46	PATIL PRATIKSHA	MECHANICAL ENGINEERING
1148	TEA47	PATIL SHANTANU NITIN MANJUSHA	MECHANICAL ENGINEERING
1149	TEA48	PAWAR ANIKET BAPU VANDANA	MECHANICAL ENGINEERING
1150	TEA49	PAWAR NIKHIL SHIVAJI LAXMI	MECHANICAL ENGINEERING
1151	TEA50	PEDGE JALINDAR SUBHASHRAO	MECHANICAL ENGINEERING
1152	TEA51	SAGWEKAR SHUBHAM VIJAY VINAYA	MECHANICAL ENGINEERING
1153	TEA52	SAWANT BHUSHAN SAMPAT SANGEETA	MECHANICAL ENGINEERING
1154	TEA53	SHEJALE SHUBHAM RAJESH ANJALI	MECHANICAL ENGINEERING
1155	TEA54	SHINDE PRATHAMESH PRAMOD PRANALI	MECHANICAL ENGINEERING
1156	TEA55	SHINDE YASH DEEPAK SAROJ	MECHANICAL ENGINEERING
1157	TEA56	SHUKLA ABHISHEK DINESHKUMAR	MECHANICAL ENGINEERING
1158	TEA57	SINGH AMIT TEJBAHADUR MANJU	MECHANICAL ENGINEERING
1159	TEA58	SUNKA VIJAY PRABHAKAR SUJATHA	MECHANICAL ENGINEERING
1160	TEA59	TEMBARE PRITAM HANUMANT	MECHANICAL ENGINEERING
1161	TEA60	THALE SANKET SANTOSH SANJIVANI	MECHANICAL ENGINEERING
1162	TEA61	THOMBARE SANKET APPA APARNA	MECHANICAL ENGINEERING
1163	TEA62	VEDAK HARSH AKASHNAND SWATI	MECHANICAL ENGINEERING
1164	TEA63	VEER TUSHAR CHANGDEO SUVARNA	MECHANICAL ENGINEERING
1165	TEA64	VHORE SHYAMSUNDAR KESHAVVHORO	MECHANICAL ENGINEERING
1166	TEA65	WADHAVE AKASH PRAKASH SUNITA	MECHANICAL ENGINEERING
1167	TEB01	ABHANG AAKASH CHAGAN	MECHANICAL ENGINEERING
1168	TEB02	ACHARYA SRIRAJ RAJENDRAN BINDU	MECHANICAL ENGINEERING
1169	TEB03	AUTADE VISHWAJEET MADHUKAR SANGIT	MECHANICAL ENGINEERING
1170	TEB04	AWATE SMITESH HANUMANTRAO SMITA	MECHANICAL ENGINEERING
1171	TEB05	BHAGAT HARSH MACHINDRA VANDANA	MECHANICAL ENGINEERING
1172	TEB06	CHAVAN GANESH BALKRISHNA RANJANA	MECHANICAL ENGINEERING
1173	TEB07	DHAMANE DHANANJAY DAGADU DARSHANA	MECHANICAL ENGINEERING
1174	TEB08	DHUMAL JAYESH VILAS BHARTI	MECHANICAL ENGINEERING
1175	TEB09	DOLARE PRASHANT BHIMRAO	MECHANICAL ENGINEERING
1176	TEB10	GAIKWAD SAHIL SANJAY SHAULSHAWARI	MECHANICAL ENGINEERING
1177	TEB11	GAVALI SIDDHESH VIKAS SNEHA	MECHANICAL ENGINEERING
1178	TEB12	GHARAT SAISHWAR SHRIKANT	MECHANICAL ENGINEERING
1179	TEB13	GHORPADE SUBODH VINAYAK VIDYA	MECHANICAL ENGINEERING

TRUE COPY

[Signature]

Principal

Vishwaniketan's (IIT) EET

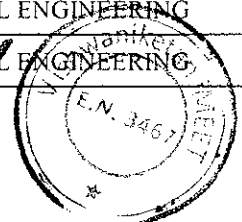

1180	TEB14	GHULE ATUL VILAS SUNANDA	MECHANICAL ENGINEERING
1181	TEB15	GIRI ROHIT PRAKASH UJJWALA	MECHANICAL ENGINEERING
1182	TEB16	GODSE OMKAR SHAILESH POOJA	MECHANICAL ENGINEERING
1183	TEB17	GORE ROHIT RANOJI SANGITA	MECHANICAL ENGINEERING
1184	TEB18	GOYAL CHIRAG MADAN USHA	MECHANICAL ENGINEERING
1185	TEB19	GUNJAL SARVESH SANTOSH SAMIKSHA	MECHANICAL ENGINEERING
1186	TEB20	HULGE ANIKET BAPURAO BABY	MECHANICAL ENGINEERING
1187	TEB21	JADHAV NIKHIL RAJENDR.	MECHANICAL ENGINEERING
1188	TEB22	JANGAM OMKAR VIJAYKUMAR SHUBHANGI	MECHANICAL ENGINEERING
1189	TEB23	KAMAT SHANKNIL	MECHANICAL ENGINEERING
1190	TEB24	KHAIRNAR HARSHAL	MECHANICAL ENGINEERING
1191	TEB25	KOLI RUSHIKESH GOVIND ASHA	MECHANICAL ENGINEERING
1192	TEB26	KONJE KALPESH RAVINDRA SUGANDHA	MECHANICAL ENGINEERING
1193	TEB27	MAYEKAR PRATIK VITHOBA VINITA	MECHANICAL ENGINEERING
1194	TEB28	MHATRE AADARSH DHARMENDRA KANCHAN	MECHANICAL ENGINEERING
1195	TEB29	MHATRE NISHANT RAVINDRA SHARDA	MECHANICAL ENGINEERING
1196	TEB30	MHATRE PRATIK PRAKASH ANJANI	MECHANICAL ENGINEERING
1197	TEB31	MHATRE VINAY RATNAKAR JAYASHRI	MECHANICAL ENGINEERING
1198	TEB32	MULAY MAHESH DNYANDEO SANGITA	MECHANICAL ENGINEERING
1199	TEB33	NANGARE SHUBHAM RAMDAS PRAMILA	MECHANICAL ENGINEERING
1200	TEB34	NARAYANKAR NAVIN DATTA VIMAL	MECHANICAL ENGINEERING
1201	TEB35	NIKAM CHAITANYA VITTHAL SUNITA	MECHANICAL ENGINEERING
1202	TEB36	PAGADE RAJ PADMAKAR MANISHA	MECHANICAL ENGINEERING
1203	TEB37	PARAB TUSHAR	MECHANICAL ENGINEERING
1204	TEB38	PARDESI ABHISHEK	MECHANICAL ENGINEERING
1205	TEB39	PATIL ABHISHEK ANKUSH VIDYA	MECHANICAL ENGINEERING
1206	TEB40	PATIL JAYESH VIJAY GEETA	MECHANICAL ENGINEERING
1207	TEB41	PATIL PRATHMESH GANESH SUJATA	MECHANICAL ENGINEERING
1208	TEB42	PATIL SAURABH	MECHANICAL ENGINEERING
1209	TEB43	PATIL SHUBHAM HARISHCHANDRA JYOTI	MECHANICAL ENGINEERING
1210	TEB44	PATIL TANAMAY	MECHANICAL ENGINEERING
1211	TEB45	PHADKE ROHIT MAYA GULAB	MECHANICAL ENGINEERING
1212	TEB46	PISAL VAIBHAV	MECHANICAL ENGINEERING
1213	TEB47	RAJGURU PIYUSH RAMESH VISHAKHA	MECHANICAL ENGINEERING
1214	TEB48	RAMDHARNE MANISH ARUN JYOTI	MECHANICAL ENGINEERING
1215	TEB49	RANE RUSHIKESH RAJENDRA RANJANA	MECHANICAL ENGINEERING
1216	TEB50	RAUT RUSHIKESH SUNIL DEVYANI	MECHANICAL ENGINEERING

TRUE COPY

Principal
Vishwaniketan (11-11-11)

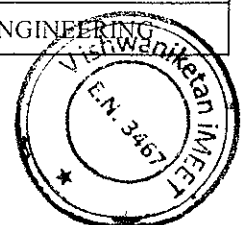

1217	TEB51	RAUT TABISH ISMAIL NASREEN	MECHANICAL ENGINEERING
1218	TEB52	SAKPAL MIHIR	MECHANICAL ENGINEERING
1219	TEB53	SALUNKHE ANKUR JANARDAN ASHA	MECHANICAL ENGINEERING
1220	TEB54	SANE GANESH	MECHANICAL ENGINEERING
1221	TEB55	SASTE VIKIN GANGARAM LADUBAI	MECHANICAL ENGINEERING
1222	TEB56	SHINDE MAYUR DATTA KALPANA	MECHANICAL ENGINEERING
1223	TEB57	SHINDE SAHIL RAJENDRA MADHURI	MECHANICAL ENGINEERING
1224	TEB58	SONAWANE VEDANT SANJAY VANDANA	MECHANICAL ENGINEERING
1225	TEB59	THAKUR BHUVANESH SANJAY SANGEETA	MECHANICAL ENGINEERING
1226	TEB60	THAKUR SANKET PRAKASH	MECHANICAL ENGINEERING
1227	TEB61	THALE PRIYAJ PRAKASH LALITA	MECHANICAL ENGINEERING
1228	TEB62	TIWARE PRANAY RAJENDRA RAJASHREE	MECHANICAL ENGINEERING
1229	TEB63	UMBARKAR AJAY VITTHAL SHASHIKALA	MECHANICAL ENGINEERING
1230	TEB64	UTALE NIKHIL MARUTI SUREKHA	MECHANICAL ENGINEERING
1231	TEB65	UTTEKAR NIKHIL SUNIL REKHA	MECHANICAL ENGINEERING
1232	BEA01	BARSHI ASHISH NARAYAN SUJATA	MECHANICAL ENGINEERING
1233	BEA02	BHOSALE VIPUL SANJAY SANGEETA	MECHANICAL ENGINEERING
1234	BEA03	CHAVAN SHUBHAM SATISH SAVITA	MECHANICAL ENGINEERING
1235	BEA04	DEO NIKHIL	MECHANICAL ENGINEERING
1236	BEA05	DESHMUKH SUYOG	MECHANICAL ENGINEERING
1237	BEA06	DWIVEDI KARAN RAJENDRA RAMSAKHI	MECHANICAL ENGINEERING
1238	BEA07	GAIKWAD ANIRUDDHA SUDHIR ARADHANA	MECHANICAL ENGINEERING
1239	BEA08	GAIKWAD JONATHAN RAJU NALINI	MECHANICAL ENGINEERING
1240	BEA09	GAWAND PRATHMESH PRAKASH VANITA	MECHANICAL ENGINEERING
1241	BEA10	GHATTARGI GAURINANDAN LAXMAN	MECHANICAL ENGINEERING
1242	BEA11	HADAWALE PRATIK KUSHABHAU PUSHPA	MECHANICAL ENGINEERING
1243	BEA12	HEGADE ROSHAN SITARAM PRABHA	MECHANICAL ENGINEERING
1244	BEA13	INGALE AKASH SUSHIL SHARMILA	MECHANICAL ENGINEERING
1245	BEA14	JAGDALE KOMAL SAMPAT	MECHANICAL ENGINEERING
1246	BEA15	KADAM NIKHIL NARENDRA MALATI	MECHANICAL ENGINEERING
1247	BEA16	LOKHANDE DHANANJAY DEVIDAS	MECHANICAL ENGINEERING
1248	BEA17	MALI SHUBHAM RAMCHANDRA LATA	MECHANICAL ENGINEERING
1249	BEA18	PAGAR SHANTANU VIJAY ANITA	MECHANICAL ENGINEERING
1250	BEA19	PATIL AKSHAY ATUL APARNA	MECHANICAL ENGINEERING
1251	BEA20	PATIL ANIKET DILIP DIPALI	MECHANICAL ENGINEERING
1252	BEA21	PATIL KALPESH RAMESH RESHMA	MECHANICAL ENGINEERING
1253	BEA22	PATIL MAHESH	MECHANICAL ENGINEERING

TRUE COPY

Principal

Vishwaniketan's MEET

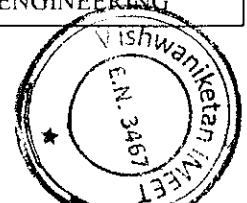

1254	BEA23	PATIL OMKAR ULHAS NEETA	MECHANICAL ENGINEERING
1255	BEA24	PATIL RAKESH RAMCHANDRA VANITA	MECHANICAL ENGINEERING
1256	BEA25	PATIL SAMEER KAILAS SANGITA	MECHANICAL ENGINEERING
1257	BEA26	PATIL SONALI EKANATH HIRA	MECHANICAL ENGINEERING
1258	BEA27	PAWADE PRIYANKA DADABHAU USHA	MECHANICAL ENGINEERING
1259	BEA28	PAWAR PRIYANKA VIJAY AARTI	MECHANICAL ENGINEERING
1260	BEA29	SALE SWAPNIL SANJAY ANJALI	MECHANICAL ENGINEERING
1261	BEA30	SALVI RUSHIKESH MAHENDRA MOHINI	MECHANICAL ENGINEERING
1262	BEA31	SAPRE MAYURESH MAHENDRA KALYANI	MECHANICAL ENGINEERING
1263	BEA32	SARUK RAHUL SHESHERAO RADHABAI	MECHANICAL ENGINEERING
1264	BEA33	SHET HARSHAL CHANDRAKANT NAYNA	MECHANICAL ENGINEERING
1265	BEA34	SINGH KARANPREET RAJINDERSINGH	MECHANICAL ENGINEERING
1266	BEA35	SINGH RAHUL SHYAMNARAYAN PRABHA	MECHANICAL ENGINEERING
1267	BEA36	THAKUR RUSHIKESH RAMESH REKHA	MECHANICAL ENGINEERING
1268	BEA37	THAKUR SIDDHESH JANARDHAN VANDANA	MECHANICAL ENGINEERING
1269	BEA38	THAKUR SUYOG GANGADHAR SAVITA	MECHANICAL ENGINEERING
1270	BEA39	VAISHAMPAYAN HRISHI SHRIKANT	MECHANICAL ENGINEERING
1271	BEA40	VALIMBE KAMALAKAR MORESHWAR	MECHANICAL ENGINEERING
1272	BEA41	VISHWAKARMA SACHHIDANAND	MECHANICAL ENGINEERING
1273	BEA42	WANI NAYAN RAJENDRA SARITA	MECHANICAL ENGINEERING
1274	BEA43	WARADE ROMIL	MECHANICAL ENGINEERING
1275	BEA44	WARDE SACHIN SHANTARAM ANITA	MECHANICAL ENGINEERING
1276	BEA45	WARE VISHAL M	MECHANICAL ENGINEERING
1277	BEA46	YADAV SUDHIRKUMAR RAMSHARAN	MECHANICAL ENGINEERING
1278	BEA47	YADAV VIMLESH MUNARAMA ASHA	MECHANICAL ENGINEERING
1279	BEA48	RASAL TEJESH SATISH ARUNA	MECHANICAL ENGINEERING
1280	BEA49	RATHOD MAHESH RAM TARABAI	MECHANICAL ENGINEERING
1281	BEA50	SALUNKE HRUSHIKESH BHARATBHUSHAN	MECHANICAL ENGINEERING
1282	BEA51	SALVE SAMEER DATTA SUNITA	MECHANICAL ENGINEERING
1283	BEA52	SAYYED KAMRAN ASIF SURAIYA	MECHANICAL ENGINEERING
1284	BEA53	SHAIKH SAHEB MOIN RESHMA	MECHANICAL ENGINEERING
1285	BEA54	SHEMBADE AKSHAYKUMAR MARUTI	MECHANICAL ENGINEERING
1286	BEA55	SHINDE GANESH RAMCHANDRA MANISHA	MECHANICAL ENGINEERING
1287	BEA56	SHIROLE SAGAR SHAHAJI SUJATA	MECHANICAL ENGINEERING
1288	BEA57	SHIVTHARE ABHISHEK ROHIDAS RUPALI	MECHANICAL ENGINEERING
1289	BEA58	SINGH CHANDAN SHAMBHU PRAMILA	MECHANICAL ENGINEERING
1290	BEA59	SOLSE AJAY ROHIDAS SUNITA	MECHANICAL ENGINEERING

TRUE COPY

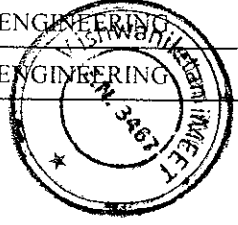

[Handwritten Signature]

Principal

Vishwaniketan's (i) M'ET

1291	BEA60	SONAWALE SUYOG DATTATRAY SUVARNA	MECHANICAL ENGINEERING
1292	BEA61	STEPHIN SAMSON SINDHU	MECHANICAL ENGINEERING
1293	BEA62	SURVE DHIRAJ SHRIRANG SAVITA	MECHANICAL ENGINEERING
1294	BEA63	SURVE SHIVAM RAJESH RUPESHA	MECHANICAL ENGINEERING
1295	BEA64	THAKUR ABHIJEET SHRIKANT AMITA	MECHANICAL ENGINEERING
1296	BEA65	THAKUR DILIP KISHOR MANISHA	MECHANICAL ENGINEERING
1297	BEA66	UGALMUGALE SANTOSH PANDURANG	MECHANICAL ENGINEERING
1298	BEA67	UPASE SWAPNIL VAIJANATH NIRMALA	MECHANICAL ENGINEERING
1299	BEA68	VIDHATE HIMALAY JAYANT SHUBHANGI	MECHANICAL ENGINEERING
1300	BEB01	AGIWALE NIKET DATTARAM PUSHPA	MECHANICAL ENGINEERING
1301	BEB02	AHIRE AKSHAY DILIP KAMAL	MECHANICAL ENGINEERING
1302	BEB03	AJAGEKAR PRATIK ANANDA SANGITA	MECHANICAL ENGINEERING
1303	BEB04	AMBATE SACHIN NARSAREDDI SUREKHA	MECHANICAL ENGINEERING
1304	BEB05	AMRALE PRATIK	MECHANICAL ENGINEERING
1305	BEB06	AUTI VISHAL JALINDAR SUNITA	MECHANICAL ENGINEERING
1306	BEB07	BADGUJAR TUSHAR BHALCHANDRA	MECHANICAL ENGINEERING
1307	BEB08	BANGAR SAURABH SHIVAJI KAVITA	MECHANICAL ENGINEERING
1308	BEB09	BHANGE HITESH RAMDAS SUMAN	MECHANICAL ENGINEERING
1309	BEB10	BHAVSAR VEDANT UMESH SHRADDHA	MECHANICAL ENGINEERING
1310	BEB11	BORLE VIRAJ RAMDAS LATA	MECHANICAL ENGINEERING
1311	BEB12	CHALVADI VIVEK VANRAJ NILEEMA	MECHANICAL ENGINEERING
1312	BEB13	CHAUDHARI HARSHAL RAJENDRA	MECHANICAL ENGINEERING
1313	BEB14	CHAVAN SAURABH SURESH BHARATI	MECHANICAL ENGINEERING
1314	BEB15	CHAVAN SURAJ SHANTARAM TEJASWINI	MECHANICAL ENGINEERING
1315	BEB16	CHOUHDARY RAKESH BHAWARLAL VIMLA	MECHANICAL ENGINEERING
1316	BEB17	CHOUGALE SAMYANTAK SANJAY	MECHANICAL ENGINEERING
1317	BEB18	DALVI OMKAR PRAMOD PRANALI	MECHANICAL ENGINEERING
1318	BEB19	DAWARE VAIBHAV PRAKASH PRAMILA	MECHANICAL ENGINEERING
1319	BEB20	DESHMUKH RATNADEEP RAMCHANDRA	MECHANICAL ENGINEERING
1320	BEB21	DHAYAL SHREEKUMAR RATANLAL	MECHANICAL ENGINEERING
1321	BEB22	DHUMAL SAURABH NAMDEV NILIMA	MECHANICAL ENGINEERING
1322	BEB23	DHURE SAURABH VISHNU VAISHANAVI	MECHANICAL ENGINEERING
1323	BEB24	GAIKAR AKSHAY YASHWANT SARITA	MECHANICAL ENGINEERING
1324	BEB25	GAIKAR RAKESH RAMESH VASANTI	MECHANICAL ENGINEERING
1325	BEB26	GAIKAR SUMEET MANOHAR SUSHMA	MECHANICAL ENGINEERING
1326	BEB27	GAIKWAD SANGRAM SHIVAJI MANISHA	MECHANICAL ENGINEERING
1327	BEB28	GAJARE ROHINI SANGITA	MECHANICAL ENGINEERING



TRUE COPY

[Signature]
Principal
Vishwaniketan's (i MEET)

1328	BEB29	GAWALI VILAS ARJUN JYOTI	MECHANICAL ENGINEERING
1329	BEB30	GHARAT ROHIT	MECHANICAL ENGINEERING
1330	BEB31	GHEWDE SAURABH MADHAV SHALINI	MECHANICAL ENGINEERING
1331	BEB32	GHOSALKAR GAURAV GURUDATTA DEVIKA	MECHANICAL ENGINEERING
1332	BEB33	GORAD VISHAL BHIMRAO MEENA	MECHANICAL ENGINEERING
1333	BEB34	GUNJAL AKSHAY SAVKAR VIDYA	MECHANICAL ENGINEERING
1334	BEB35	HEGDE SUMANTH SURESH VILASINI	MECHANICAL ENGINEERING
1335	BEB36	MHATRE TUSHAR VITTHAL ROHINI	MECHANICAL ENGINEERING
1336	BEB37	JADHAV ASHOK GANGADHAR MANISHA	MECHANICAL ENGINEERING
1337	BEB38	JAGDALE ADITYA AJAYKUMAR ADITI	MECHANICAL ENGINEERING
1338	BEB39	JAGTAP ABHISHEK DADASAHEB UJWALA	MECHANICAL ENGINEERING
1339	BEB40	JAMBHALE MAYUR NATHURAM NANDA	MECHANICAL ENGINEERING
1340	BEB41	JAMBHALIKAR ATUL ASHOK PRATIBHA	MECHANICAL ENGINEERING
1341	BEB42	JANGAM ANIKET SUHAS ANJANA	MECHANICAL ENGINEERING
1342	BEB43	JATKAR AYYAZ HUSSAIN AHISHA	MECHANICAL ENGINEERING
1343	BEB44	JAUNJAL NAGESH PRADEEP JYOTI	MECHANICAL ENGINEERING
1344	BEB45	JUIKAR KARANRAJ PRAVIN SUJATA	MECHANICAL ENGINEERING
1345	BEB46	JUIKAR MITESH JANARDAN SANGITA	MECHANICAL ENGINEERING
1346	BEB47	KAMBLE PRANIL DNYANESHWAR SHEETAL	MECHANICAL ENGINEERING
1347	BEB48	KARANDE TEJAS DAJI MANISHA	MECHANICAL ENGINEERING
1348	BEB49	KHANDAKALE KUNDAN RAMESH GEETA	MECHANICAL ENGINEERING
1349	BEB50	KHARAT AKSHAY ANNA LAXMI	MECHANICAL ENGINEERING
1350	BEB51	KHATALE DEEPAK BABLING NIRANJANI	MECHANICAL ENGINEERING
1351	BEB52	KHOT RUSHIKESH HANAMANT BHARATI	MECHANICAL ENGINEERING
1352	BEB53	KUMBHAR SACHIN	MECHANICAL ENGINEERING
1353	BEB54	LAD SANDESH VILAS VAISHALI	MECHANICAL ENGINEERING
1354	BEB55	MANDHARE DEEPAK DATTARAY SNEHALATA	MECHANICAL ENGINEERING
1355	BEB56	MEKALE SACHIN SANJAY ARUNA	MECHANICAL ENGINEERING
1356	BEB57	MHATRE AKSHAY NAMDEO KAVITA	MECHANICAL ENGINEERING
1357	BEB58	MHATRE JAYESH VISHWANATH	MECHANICAL ENGINEERING
1358	BEB59	MHATRE PRATIK DATTARAM PRIYA	MECHANICAL ENGINEERING
1359	BEB60	MHATRE RITESH KISHOR	MECHANICAL ENGINEERING
1360	BEB61	MHATRE SANMIT SANTOSH SWATI	MECHANICAL ENGINEERING
1361	BEB62	MOHAPE PRAJYOT HANUMANT HARSHALA	MECHANICAL ENGINEERING
1362	BEB63	NAIK SHUBHANKAR PRAVIN SHACHI	MECHANICAL ENGINEERING
1363	BEB64	NALAWADE AKSHAY KISAN REKHA	MECHANICAL ENGINEERING
1364	BEB65	NEVAREKAR NIMISH HEMKANT HARSHAL	MECHANICAL ENGINEERING

TRUE COPY

J.P.
Principal

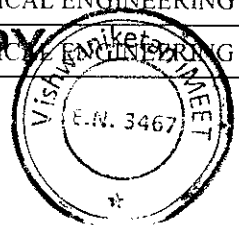

1365	BEB66	PANDHARE AKSHAY MADHUKAR UJAWALA	MECHANICAL ENGINEERING
1366	BEB67	PANGARE MOHAN JAYANTA PUSHPA	MECHANICAL ENGINEERING
1367	BEB68	PARINGE SHRIKANT MARUTI SANGEETA	MECHANICAL ENGINEERING
1368	BEB69	PATIL DIVYANK NANDAKUMAR REKHA	MECHANICAL ENGINEERING
1369	BEB70	PATIL MANISH	MECHANICAL ENGINEERING
1370	BEB71	PATIL OMKAR BHASKAR ASHA	MECHANICAL ENGINEERING
1371	BEB72	PATIL RUSHIKESH VASANT VANDANA	MECHANICAL ENGINEERING
1372	BEB73	PATIL SANKET RAMESH UTTARA	MECHANICAL ENGINEERING
1373	BEB74	PATIL SARVESH SURESH SARITA	MECHANICAL ENGINEERING
1374	BEB75	PAWAR ROHAN S	MECHANICAL ENGINEERING
1375	BEB76	PAWAR SURAJ DILIP RESHMA	MECHANICAL ENGINEERING
1376	BEB77	PHADTARE SANKET SANJAY NANDA	MECHANICAL ENGINEERING
1377	BEB78	POWAR TUSHAR SHRIPATI MANGAL	MECHANICAL ENGINEERING
1378	BEB79	PRAJAPATI RAMBABU DAYASHANKAR	MECHANICAL ENGINEERING
1379	BEB80	RANANAVARE OMKAR GOPAL KESHAR	MECHANICAL ENGINEERING

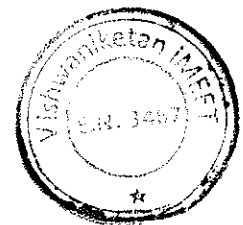

TRUE COPY

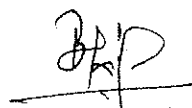
 Principal
 Vishwaniketan's (iMEET)

VISHWANIKETAN

Institute of Management Entrepreneurship and Engineering Technology

Survey No-52 Off Mumbai-Pune Expressway Kumbhivali,

Tal- Khalapur, Maharashtra 410203.

Phone: (02192) 274206/274207/274208/274210



VISHWANIKETAN

2019-2020

Sr. No.	Roll No.	Name of Student	Name of Program
1	SEA01	BAGUL OM	CIVIL ENGINEERING
2	SEA02	CHAVARKAR ADWAIT SANJAY	CIVIL ENGINEERING
3	SEA03	DESHMUKH GANESH	CIVIL ENGINEERING
4	SEA04	DESHMUKH PRASHANT SHIVAJIRAO	CIVIL ENGINEERING
5	SEA05	DHANAWADE SANDESH DATTATRAY	CIVIL ENGINEERING
6	SEA06	DHOLAKIA VIREN	CIVIL ENGINEERING
7	SEA07	GAIKWAD AKSHAY MAHENDRA	CIVIL ENGINEERING
8	SEA08	GAIKWAD KETAN RAJESH	CIVIL ENGINEERING
9	SEA09	GAIKWAD SHUBHAM ANANTA	CIVIL ENGINEERING
10	SEA10	GAVAT RAHUL ANANTA	CIVIL ENGINEERING
11	SEA11	JADHAV AVISHKAR ASHOK	CIVIL ENGINEERING
12	SEA12	JADHAV SAHIL SANDIP	CIVIL ENGINEERING
13	SEA13	JADHAV SANKET	CIVIL ENGINEERING
14	SEA14	KADAM PRANAY PRAMOD	CIVIL ENGINEERING
15	SEA15	KAPURE SUDEEP K	CIVIL ENGINEERING
16	SEA16	M.S MELVIN ABHIJIT	CIVIL ENGINEERING
17	SEA17	MANE PRIYANKA MOHAN	CIVIL ENGINEERING
18	SEA18	MEMAN SAHIL ALTAF	CIVIL ENGINEERING
19	SEA19	MHATRE RITESH RAVINDRA	CIVIL ENGINEERING
20	SEA20	MOHAMMAD AMAN KHAN	CIVIL ENGINEERING
21	SEA21	PATIL ROHIT PRATAPRAO	CIVIL ENGINEERING
22	SEA22	SALUNKE RUSHIKESH RAMLING	CIVIL ENGINEERING
23	SEA23	SHAH PARTH NIMISH	CIVIL ENGINEERING
24	SEA24	VARTAK SHUBHAM DEVIDAS	CIVIL ENGINEERING
25	SEA25	VARTAK SHUBHAM PRAVIN	CIVIL ENGINEERING
26	SEA26	WAGH YASH SANJAY	CIVIL ENGINEERING
27	SEA27	BAIS SARTHAK KACHRUSINGH	CIVIL ENGINEERING
28	SEA28	BANDAL MANGESH VIJA	CIVIL ENGINEERING
29	SEA29	BEHERA FALESHWAR JAYARAM	CIVIL ENGINEERING
30	SEA30	BHALEKAR MAYURI RAJU	CIVIL ENGINEERING

TRUE COPY



Principal
Vishwaniketan's (I MEET)

31	SEA31	BHOSALE PRAVIN SARJERAO	CIVIL ENGINEEING
32	SEA32	BHUSANE SAHIL ASHOK	CIVIL ENGINEEING
33	SEA33	BURKUL SANDESH SIDRAM	CIVIL ENGINEEING
34	SEA34	CHAVAN SACHIN VISHNU	CIVIL ENGINEEING
35	SEA35	CHAVAN SHREYASH SHRIKANT	CIVIL ENGINEEING
36	SEA36	CHAVAN SHRIDIAR SHRIPATI	CIVIL ENGINEEING
37	SEA37	CHOUDHARY VIKAS NARENDAR	CIVIL ENGINEEING
38	SEA38	DALVE ABHISHEK NAMDEV	CIVIL ENGINEEING
39	SEA39	DALVI PRATIK PANDURANG	CIVIL ENGINEEING
40	SEA40	DALVI SHUBHAM SANTOSH	CIVIL ENGINEEING
41	SEA41	DEMANE MRUNAL RAJESH	CIVIL ENGINEEING
42	SEA42	DESHPANDE SUYASH YESHWANT	CIVIL ENGINEEING
43	SEA43	DHARANE KETAKI SURESH	CIVIL ENGINEEING
44	SEA44	DHUMAL POOJA SANJAY	CIVIL ENGINEEING
45	SEA45	DOMB BALRAJ MADHUKAR	CIVIL ENGINEEING
46	SEA46	GAIKWAD TEJASHREE GANESH	CIVIL ENGINEEING
47	SEA47	GHOLAP SAURABH SANJAY	CIVIL ENGINEEING
48	SEA48	GUJAR ADITYA DNYANESHWAR	CIVIL ENGINEEING
49	SEA49	GUNJAL NEHAL PRAMOD	CIVIL ENGINEEING
50	SEA50	HALSE PRAVEEN JAIPRAKASH	CIVIL ENGINEEING
51	SEA51	HAMBIR JANARDAN JANU	CIVIL ENGINEEING
52	SEA52	JADHAV ADITYA HARESH	CIVIL ENGINEEING
53	SEA53	JADHAV SHIVCHARAN H	CIVIL ENGINEEING
54	SEA54	JADHAV VISHAL DILIP	CIVIL ENGINEEING
55	SEA55	JANGAM AKSHAY ANIL	CIVIL ENGINEEING
56	SEA56	KADAM HEMANGI DEVIDAS	CIVIL ENGINEEING
57	SEA57	KADAM LILADHAR NAGESH	CIVIL ENGINEEING
58	SEA58	KADAM NIRAJ RAJESH	CIVIL ENGINEEING
59	SEA59	KADAM SONAL NARAYAN	CIVIL ENGINEEING
60	SEA60	KAMBLE SONALI DEEPAK	CIVIL ENGINEEING
61	SEA61	KARALE NISHANT ARVIND	CIVIL ENGINEEING
62	SEA62	KHARATMAL TEJAS SURESH	CIVIL ENGINEEING
63	SEA63	KHARATMOL AKASH PANDURANG	CIVIL ENGINEEING
64	SEA64	KOLHE SAKSHI JITEND	CIVIL ENGINEEING
65	SEA65	KOLI VIRESH HARESH	CIVIL ENGINEEING
66	SEA66	KOTHARI NAYAN YOGESH	CIVIL ENGINEEING
67	SEA67	KURE HITESH SANDEEP	CIVIL ENGINEEING

TRUE COPY

Principal

Vishwaniketan's (I MEEET)

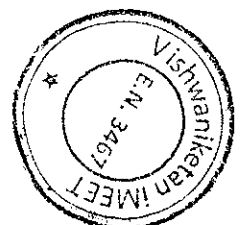

68	SEA68	KURLE VAIBHAV UTTAM	CIVIL ENGINEERING
69	SEA69	LAD SIDDHESH NANDKUMAR	CIVIL ENGINEERING
70	SEA70	MAKAJI RUTIK GAJANAN	CIVIL ENGINEERING
71	SEA71	MALVANKAR KARAN VIJAY	CIVIL ENGINEERING
72	SEA72	MHAMUNKR RAJ JAYWANT	CIVIL ENGINEERING
73	SEA73	MHIATRE NILIMA BHANUDAS	CIVIL ENGINEERING
74	SEB01	MISAL MAHESH UDDHAV	CIVIL ENGINEERING
75	SEB02	MISHRA ADITYANATH LALANKUMAR	CIVIL ENGINEERING
76	SEB03	MITHAGARE MAYUR NANDKUMAR	CIVIL ENGINEERING
77	SEB04	MOHITE ATUL RAHUL	CIVIL ENGINEERING
78	SEB05	MOHITE SWATI SANDEEP	CIVIL ENGINEERING
79	SEB06	MORE MANTHAN SHIRISH	CIVIL ENGINEERING
80	SEB07	MORE PRATHAMESH TANAJI	CIVIL ENGINEERING
81	SEB08	MORE SHRUTI SANTOSH	CIVIL ENGINEERING
82	SEB09	MULIK PRATIK BAPUSAB	CIVIL ENGINEERING
83	SEB10	MULLA USAMA HANIF	CIVIL ENGINEERING
84	SEB11	NAIK CHINMAY SANTOSH	CIVIL ENGINEERING
85	SEB12	NAIK PRATIK EKNATH	CIVIL ENGINEERING
86	SEB13	NANGARE ADITI	CIVIL ENGINEERING
87	SEB14	NIKHALJE ABHISEK	CIVIL ENGINEERING
88	SEB15	NIKAM NIKHIL ANKUSH	CIVIL ENGINEERING
89	SEB16	NIMBALKAR HRUTVIKA AVINASH	CIVIL ENGINEERING
90	SEB17	PALVE AKASH VINAYAK	CIVIL ENGINEERING
91	SEB18	PANDHARE HRUTUJA TAYAPPA	CIVIL ENGINEERING
92	SEB19	PARAMMAL ABHINAV THAMBAN	CIVIL ENGINEERING
93	SEB20	PARANGE ROHAN LILADHAR	CIVIL ENGINEERING
94	SEB21	PARDESHI MOHITE B	CIVIL ENGINEERING
95	SEB22	PASWAN NIKET RAJENDRA	CIVIL ENGINEERING
96	SEB23	PATIL ABHIJEET AVINASH	CIVIL ENGINEERING
97	SEB24	PATIL AVADHOOT SANTOSH	CIVIL ENGINEERING
98	SEB25	PATIL HRITIK GAJANAN	CIVIL ENGINEERING
99	SEB26	PATIL JAIRAJ RAVINDRA	CIVIL ENGINEERING
100	SEB27	PATIL KAPIL GAJANAN GITANJALI	CIVIL ENGINEERING
101	SEB28	PATIL KAVISH RAJENDRA	CIVIL ENGINEERING
102	SEB29	PATIL MAHESH KASHINATH	CIVIL ENGINEERING
103	SEB30	PATIL NAMISH SOMNATH	CIVIL ENGINEERING
104	SEB31	PATIL PRAJWAL ARVIND	CIVIL ENGINEERING

TRUE COPY

[Signature]
Principal

Vishwaniketan's (I MEET)

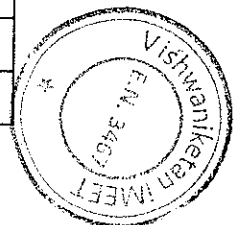

105	SEB32	PATIL PRASAD SANTOSH	CIVIL ENGINEERING
106	SEB33	PATIL PRASAD VILAS	CIVIL ENGINEERING
107	SEB34	PATIL RUSHIKESH ANANDA	CIVIL ENGINEERING
108	SEB35	PATIL RUTUJA ARAVIND	CIVIL ENGINEERING
109	SEB36	PATIL SHRIYASH SHRIKANT	CIVIL ENGINEERING
110	SEB37	PATIL SHUBHAM ASHOK	CIVIL ENGINEERING
111	SEB38	PATIL SUDHIR HANUMANT	CIVIL ENGINEERING
112	SEB39	PATIL SWAPNALI KISHOR	CIVIL ENGINEERING
113	SEB40	PATIL YASHRAJ RAMESH	CIVIL ENGINEERING
114	SEB41	PAWAR HARSHAL HANUMANT	CIVIL ENGINEERING
115	SEB42	PAWAR MANOJ NANDU	CIVIL ENGINEERING
116	SEB43	PAWAR SANKET BHAGWAN	CIVIL ENGINEERING
117	SEB44	PORE MITALI MAHESH	CIVIL ENGINEERING
118	SEB45	POWAR RAHUL BHIMRAO	CIVIL ENGINEERING
119	SEB46	QADRI HANZALA MOHAMMED JUNAID	CIVIL ENGINEERING
120	SEB47	QUADRI ABDULKADIR FAIYYAZAMED RAHISA	CIVIL ENGINEERING
121	SEB48	RAUT AKANKSHA NISHIKANT	CIVIL ENGINEERING
122	SEB49	SABLE GAURAV SANTOSH	CIVIL ENGINEERING
123	SEB50	SAHA KRISHNA SUKLAL	CIVIL ENGINEERING
124	SEB51	SAKPAL AMAR HANUMANT	CIVIL ENGINEERING
125	SEB52	SALUNKE SAYALI SUNIL	CIVIL ENGINEERING
126	SEB53	SALVI PRATIK PRAFULL	CIVIL ENGINEERING
127	SEB54	SAWANT HERAMB RAM	CIVIL ENGINEERING
128	SEB55	SAWANT LATIKA EKANATH	CIVIL ENGINEERING
129	SEB56	SHAH BRIJESH HARESH	CIVIL ENGINEERING
130	SEB57	SHAIKH FARDEEN ASIFUDDIN	CIVIL ENGINEERING
131	SEB58	SHAIKH PARVEJ MOHMADSHARIF	CIVIL ENGINEERING
132	SEB59	SHARMA TARUN SANJAY	CIVIL ENGINEERING
133	SEB60	SHIGWAN SAURABH RAMESH	CIVIL ENGINEERING
134	SEB61	SHINDE KIRAN KISHOR	CIVIL ENGINEERING
135	SEB62	SHINDE PRAKASH UDDHAV ASHA	CIVIL ENGINEERING
136	SEB63	SHIRKE SIDDHESH DATTA	CIVIL ENGINEERING
137	SEB64	SINGH SACHIN SHIVLAL KIRAN	CIVIL ENGINEERING
138	SEB65	SINGH SANJIVKUMAR UMASHANKAR	CIVIL ENGINEERING
139	SEB66	SONAWANE RUPALI RANJAN	CIVIL ENGINEERING
140	SEB67	SURYAVANSHI AMOL ANURATHRAO	CIVIL ENGINEERING
141	SEB68	TATHARE SHRUTI VINAYAK	CIVIL ENGINEERING

TRUE COPY

Principal
Vishwaniketan's (I MEET)

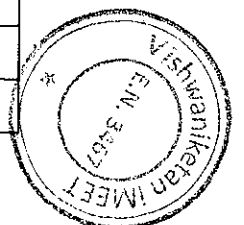

142	SEB69	THAILI HEMANT APINATHI	CIVIL ENGINEERING
143	SEB70	THAKUR SAHIL JAYWANI	CIVIL ENGINEERING
144	SEB71	THUPPADA HARISH NARAYAN	CIVIL ENGINEERING
145	SEB72	UKARANDE OMKAR VILAS	CIVIL ENGINEERING
146	SEB73	WAGHAMARE RAJESH GANPAT	CIVIL ENGINEERING
147	SEB74	YADAV AKHILESH BAPU	CIVIL ENGINEERING
148	TEA01	ACHARYA VARUN GANPAT	CIVIL ENGINEERING
149	TEA02	AHIRRAO SNEHA RAJARAM	CIVIL ENGINEERING
150	TEA03	AMANE PRADYUMNA SHIVANAND	CIVIL ENGINEERING
151	TEA04	BARASKAR DEVYANI	CIVIL ENGINEERING
152	TEA05	BASARE SHRADDHA	CIVIL ENGINEERING
153	TEA06	BATHIJA KUNAL R.	CIVIL ENGINEERING
154	TEA07	BEDSE JAYESH DIPAK	CIVIL ENGINEERING
155	TEA08	BELOTE VISHAL PAPPU	CIVIL ENGINEERING
156	TEA09	BHAGAT DHAVAL DINESH	CIVIL ENGINEERING
157	TEA10	BHAGAT PRANAY	CIVIL ENGINEERING
158	TEA11	BHAGAT SARVESH JAGDISH	CIVIL ENGINEERING
159	TEA12	BHAT WASEEM	CIVIL ENGINEERING
160	TEA13	BHORING SAGAR MANUBHAI	CIVIL ENGINEERING
161	TEA14	BHUJBAL MEGHA DINKAR	CIVIL ENGINEERING
162	TEA15	BORKAR ADITYA PRADEEP	CIVIL ENGINEERING
163	TEA16	BUGADE SACHIN TANAJI	CIVIL ENGINEERING
164	TEA17	CHIAUDHARY SHEFALI HEMANT	CIVIL ENGINEERING
165	TEA18	CHAVARE TANVI	CIVIL ENGINEERING
166	TEA19	CHAVHAN SWARAJ VISHWAS	CIVIL ENGINEERING
167	TEA20	CHOUDHARI DARSHAN ANIL	CIVIL ENGINEERING
168	TEA21	DALVI NINAD NAMDEO	CIVIL ENGINEERING
169	TEA22	DAMARE RITESH TANAJI	CIVIL ENGINEERING
170	TEA23	DANDEKAR NIKHIL JAYENDRA	CIVIL ENGINEERING
171	TEA24	DAYANAND SUBHASH INDUBAI	CIVIL ENGINEERING
172	TEA25	DESHMUKH PRATHMESH NARESH	CIVIL ENGINEERING
173	TEA26	DESHMUKH ANKITA VIKAS	CIVIL ENGINEERING
174	TEA27	DESHMUKH SHUBHAM SANJAY	CIVIL ENGINEERING
175	TEA28	DHAWALE GITANJLI GOVIND	CIVIL ENGINEERING
176	TEA29	DHEMBRE PRATHMESH APAS	CIVIL ENGINEERING
177	TEA30	DHOKALE BALAJI DADASAHEB	CIVIL ENGINEERING
178	TEA31	DHUMAL GANESH RAJENDRA	CIVIL ENGINEERING

TRUE COPY

Principal

Vishwaniketan's (i MEET)



179	TEA32	FERNANDES ALVES	CIVIL ENGINEERING
180	TEA33	GADADE SHUBHAM BIRUDEO	CIVIL ENGINEERING
181	TEA34	GAIKWAD KALPESH LAXMAN	CIVIL ENGINEERING
182	TEA35	GAIKWAD ANKITA ASHOK	CIVIL ENGINEERING
183	TEA36	GAIKWAD SARTHA SAGAR	CIVIL ENGINEERING
184	TEA37	GARDI OMKAR NARENDRA	CIVIL ENGINEERING
185	TEA38	GAVATE HITESH JANARDAN NILIMA	CIVIL ENGINEERING
186	TEA39	GAWADE VAIBHAV SUBHASH	CIVIL ENGINEERING
187	TEA40	GAWALI PRASHANT ARJUN	CIVIL ENGINEERING
188	TEA41	GAWAND DIVYA DINANATH	CIVIL ENGINEERING
189	TEA42	GHADGE SANDESH RAJENDRA	CIVIL ENGINEERING
190	TEA43	GHADI NIKHIL PRAMOD	CIVIL ENGINEERING
191	TEA44	GHARAT VRUSHALI SHIRISH	CIVIL ENGINEERING
192	TEA45	GHARAT DIWANGI MANOJ	CIVIL ENGINEERING
193	TEA46	GHASTI PRANAY SANJAY	CIVIL ENGINEERING
194	TEA47	GHAVATE RAJ ANIL	CIVIL ENGINEERING
195	TEA48	GOSAVI HRUSHIKESH SHRIRAM	CIVIL ENGINEERING
196	TEA49	GUJAR SHUBHAM ANIL	CIVIL ENGINEERING
197	TEA50	GURAO GAYATRI ANKUSH	CIVIL ENGINEERING
198	TEA51	GURAV NIKHIL UDAY	CIVIL ENGINEERING
199	TEA52	HAJARE VAIBHAV SURESH	CIVIL ENGINEERING
200	TEA53	HANDE RUSHIKESH RAMCHANDRA	CIVIL ENGINEERING
201	TEA54	HIRTHICK BHARANI	CIVIL ENGINEERING
202	TEA55	INARKAR ANKUSH	CIVIL ENGINEERING
203	TEA56	INKAR TEJAS RAHUL	CIVIL ENGINEERING
204	TEA57	JADHAV AKSHAY RAMESH	CIVIL ENGINEERING
205	TEA58	JADHAV NIKHIL KAILAS	CIVIL ENGINEERING
206	TEA59	JADHAV NILESH MURALI	CIVIL ENGINEERING
207	TEA60	JADHAV RAHUL SHANKAR	CIVIL ENGINEERING
208	TEA61	JADHAV RAJKUMAR SUNIL	CIVIL ENGINEERING
209	TEA62	JADHAV SARVESH SANDEEP	CIVIL ENGINEERING
210	TEA63	JADHAV SHIVANI ANANT	CIVIL ENGINEERING
211	TEA64	JADHAV SHIVRAJ SHAHAJI	CIVIL ENGINEERING
212	TEA65	JAGDALE SAGAR	CIVIL ENGINEERING
213	TEA66	JAIWAR PRANSHU RAMLAL	CIVIL ENGINEERING
214	TEA67	JEURGI PRATIK CHANDRASHEKHAR	CIVIL ENGINEERING
215	TEA68	JOSHI SIDDHANT GANESH	CIVIL ENGINEERING

TRUE COPY

[Signature]
Principal

Vishwaniketan's (I.M.E.T).

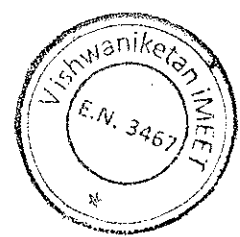

216	TEA69	KABURE GAJANAN APPASO	CIVIL ENGINEERING
217	TEA70	KACHARE VIVEK	CIVIL ENGINEERING
218	TEA71	KAMBLE ANKUR RAJESH	CIVIL ENGINEERING
219	TEA72	KAMBLE VIVEK SUNIL	CIVIL ENGINEERING
220	TEA73	KARANJKAR AKASH RAJEBHAU	CIVIL ENGINEERING
221	TEA74	KARDE SHUBHAM PRAKASH	CIVIL ENGINEERING
222	TEA75	KATRODIA MITANSHU MANISH	CIVIL ENGINEERING
223	TEA76	KHADAKBAN SUYOG VAIBHAV	CIVIL ENGINEERING
224	TEA77	KHADE MAYURI DATTATRAY	CIVIL ENGINEERING
225	TEA78	KHALOKAR SUSHANT AJAY	CIVIL ENGINEERING
226	TEA79	KHANDALKAR ADITYA BALKRISHNA	CIVIL ENGINEERING
227	TEA80	KHARATMOL SAGAR PANDURANG	CIVIL ENGINEERING
228	TEA81	KHEDKAR AKSHAY ANAND	CIVIL ENGINEERING
229	TEA82	KODAG AKASH GORAKH	CIVIL ENGINEERING
230	TEA83	KOLAMBE TUSHAR BHAGWAN	CIVIL ENGINEERING
231	TEA84	KOLEKAR AMOL JAGANNATH	CIVIL ENGINEERING
232	TEA85	KOLEKAR PRATIK NAMDEO	CIVIL ENGINEERING
233	TEA86	KOR GANESH SHANTARAM	CIVIL ENGINEERING
234	TEA87	KOTIWALE AVISHKAR IRAPPA	CIVIL ENGINEERING
235	TEA88	KUMAVAT KARAN ANAND	CIVIL ENGINEERING
236	TEA89	KUMAVAT KIRAN DAGA	CIVIL ENGINEERING
237	TEA90	KUNDALE SWAPNIL	CIVIL ENGINEERING
238	TEB01	MADAKE ROSHANI SURESH	CIVIL ENGINEERING
239	TEB02	MAHADIK ADITYA KASHINATH	CIVIL ENGINEERING
240	TEB03	MAHALE KIRAN HARISH	CIVIL ENGINEERING
241	TEB04	MAHANUR SURAJ	CIVIL ENGINEERING
242	TEB05	MALKAR ROHIT GHANSHYAM	CIVIL ENGINEERING
243	TEB06	MANDAVKAR MANSI SUDHAKAR	CIVIL ENGINEERING
244	TEB07	MANE PRASAD VIKAS	CIVIL ENGINEERING
245	TEB08	MASANE KAPIL	CIVIL ENGINEERING
246	TEB09	MASKE VIKAS MUNJAJI	CIVIL ENGINEERING
247	TEB10	MHATRE ADITYA R.	CIVIL ENGINEERING
248	TEB11	MHATRE CHIRAYU JAHINDRANATH	CIVIL ENGINEERING
249	TEB12	MHATRE NISHANT MANOHAR	CIVIL ENGINEERING
250	TEB13	MHATRE NISHITA YASHVAN	CIVIL ENGINEERING
251	TEB14	MHATRE PRANAV VILAS	CIVIL ENGINEERING
252	TEB15	MHATRE PRATIKESH SHANKAR	CIVIL ENGINEERING

TRUE COPY

[Signature]

Vishwaniketan



253	TEB16	MHATRE RAHUL ASHOK	CIVIL ENGINEEING
254	TEB17	MHATRE SAMIR	CIVIL ENGINEEING
255	TEB18	MHATRE SAURABH TUKARAM	CIVIL ENGINEEING
256	TEB19	MHATRE TEJAS HEMANT	CIVIL ENGINEEING
257	TEB20	MHATRE TEJASVI RAVINDRA	CIVIL ENGINEEING
258	TEB21	MOKAL MINAL JAYARAM	CIVIL ENGINEEING
259	TEB22	MOTE TEJAS CHANDRAKANT	CIVIL ENGINEEING
260	TEB23	MULEY PRANAY TEJRAO	CIVIL ENGINEEING
261	TEB24	MULLA SAJADA SHAFAHATAHAMAD	CIVIL ENGINEEING
262	TEB25	NAIK KETAN PADAJI	CIVIL ENGINEEING
263	TEB26	NANDGAONKAR RUTUJA SANTOSH	CIVIL ENGINEEING
264	TEB27	NARONA H. SHASHIKANT	CIVIL ENGINEEING
265	TEB28	NARVEKAR RUTIK ADIK	CIVIL ENGINEEING
266	TEB29	NIMBALKAR SUPRIYA GANPAT	CIVIL ENGINEEING
267	TEB30	NIVALE BALKRUSHNA LAXMAN	CIVIL ENGINEEING
268	TEB31	PACHARNE BHAVNA NANASAHEB	CIVIL ENGINEEING
269	TEB32	PADWAL SOHAN N	CIVIL ENGINEEING
270	TEB33	PAL SHUBHAM YASHWANT	CIVIL ENGINEEING
271	TEB34	PANDEY ARVIND RAMSAGAR	CIVIL ENGINEEING
272	TEB35	PANDEY NEERAJ RAMCHANDRA	CIVIL ENGINEEING
273	TEB36	PANDHARE AKSHAY	CIVIL ENGINEEING
274	TEB37	PARDESHI RUSHIKESH CHANDRAKANT	CIVIL ENGINEEING
275	TEB38	PAREKH RUSHABH MILAN	CIVIL ENGINEEING
276	TEB39	PATEL VEENA DHANJI	CIVIL ENGINEEING
277	TEB40	PATIL KAJAL DILIP	CIVIL ENGINEEING
278	TEB41	PATIL PRITIKA KIRIT	CIVIL ENGINEEING
279	TEB42	PATIL RAHUL SURESH	CIVIL ENGINEEING
280	TEB43	PATIL SANJANA SANDESH	CIVIL ENGINEEING
281	TEB44	PATIL AKASH GANESH	CIVIL ENGINEEING
282	TEB45	PATIL GITANJALI JAYAWANT	CIVIL ENGINEEING
283	TEB46	PATIL JAYESH MOHAN	CIVIL ENGINEEING
284	TEB47	PATIL KALYAN PRALHAD	CIVIL ENGINEEING
285	TEB48	PATIL OMKAR SARYAKANT	CIVIL ENGINEEING
286	TEB49	PATIL PARAMVIR PANDURANG	CIVIL ENGINEEING
287	TEB50	PATIL PAYAL KISHOR	CIVIL ENGINEEING
288	TEB51	PATIL PREETI SANTOSH	CIVIL ENGINEEING
289	TEB52	PATIL RONAK SANJIVAN	CIVIL ENGINEEING

TRUE COPY

[Signature]

Principal

Vishwaniketan's (I.M.E.T)



290	TEB53	PATIL RUTUJA ARUN	CIVIL ENGINEERING
291	TEB54	PATIL SAHILEE PARSHURAM	CIVIL ENGINEERING
292	TEB55	PATIL SAMIKSHA HANUMAN	CIVIL ENGINEERING
293	TEB56	PATIL TUSHAR VIJAY	CIVIL ENGINEERING
294	TEB57	PATIL VINAYA MADAN	CIVIL ENGINEERING
295	TEB58	PATRIKAR SHASHWAT VINOD	CIVIL ENGINEERING
296	TEB59	PAWAR ASHUTOSH SHIVAJI	CIVIL ENGINEERING
297	TEB60	PAWAR CHAITANYA MILIND	CIVIL ENGINEERING
298	TEB61	PAWAR DHANANJAY DILIP	CIVIL ENGINEERING
299	TEB62	PAWAR OMKAR NARAYAN	CIVIL ENGINEERING
300	TEB63	PAWAR SANJAY SOMA	CIVIL ENGINEERING
301	TEB64	PUNYARTHI RUSHIKESH SADANAND	CIVIL ENGINEERING
302	TEB65	QUREISHI NOORUDDIN AHMED	CIVIL ENGINEERING
303	TEB66	SALAVI DARSHAN MANOHAR	CIVIL ENGINEERING
304	TEB67	SALEKAR LAUKIK BHARAT	CIVIL ENGINEERING
305	TEB68	SALUNKE ABHISHEK GANESH	CIVIL ENGINEERING
306	TEB69	SAWANT VIJAY SUNIL	CIVIL ENGINEERING
307	TEB70	SAYYED HASAN AHMED	CIVIL ENGINEERING
308	TEB71	SHAIKH FAIYYAZ SAYYAD	CIVIL ENGINEERING
309	TEB72	SHAIKH IMAMUL JAKIR	CIVIL ENGINEERING
310	TEB73	SHAIKH SAAD ARSHAD	CIVIL ENGINEERING
311	TEB74	SHETYE RIDDHI ASHISH MANSI	CIVIL ENGINEERING
312	TEB75	SHINDE NIKHIL RAMESH	CIVIL ENGINEERING
313	TEB76	SHIRSAT ABHAY VITHOBA	CIVIL ENGINEERING
314	TEB77	SAUNDALKAR AKSHAY SAKHARAM	CIVIL ENGINEERING
315	TEB78	SOY ANAND NANDLAL	CIVIL ENGINEERING
316	TEB79	SURVE CHAITANYA SANJAY	CIVIL ENGINEERING
317	TEB80	TAMBADE GOPINATH RAJENDRA	CIVIL ENGINEERING
318	TEB81	TAMBOLI SUSHANT MADHUKAR	CIVIL ENGINEERING
319	TEB82	TEMBARE SIMRAN NANASAHEB	CIVIL ENGINEERING
320	TEB83	THAKUR SAHIL MANOHAR	CIVIL ENGINEERING
321	TEB84	THAKUR SURAJ BHARAT	CIVIL ENGINEERING
322	TEB85	THAKUR VAIBHAV VISHNU	CIVIL ENGINEERING
323	TEB86	VIRULKAR DHANSHRI ISHWAR	CIVIL ENGINEERING
324	TEB87	WAGH SAURABH MADHUKAR	CIVIL ENGINEERING
325	TEB88	WAGHMARE ANKITA ASHOK	CIVIL ENGINEERING
326	TEB89	WAGHULE KETAN BABASAHEB	CIVIL ENGINEERING

TRUE COPY

Vishwaniketan's (I.M.E.E.T.)

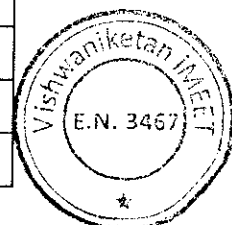

327	TEB90	WANALEKAR VARSHA HANUMANTRAO	CIVIL ENGINEEING
328	TEB91	WARKE SHWETA SUDHAKAR	CIVIL ENGINEEING
329	TEB92	YADAV ANIKET MAHENDRA	CIVIL ENGINEEING
330	TEB93	YADAV NIRANJAN VITTHAL	CIVIL ENGINEEING
331	BEA01	AMBADE VISHAKHA VINOD	CIVIL ENGINEEING
332	BEA02	AWALE SUPRIYA SIFARAM	CIVIL ENGINEEING
333	BEA03	BENDRE BHAGYASHREE RAVINDRA	CIVIL ENGINEEING
334	BEA04	BHASE PRANAL RAMBHAJI	CIVIL ENGINEEING
335	BEA05	BHILARE SURAJ PRAKASH	CIVIL ENGINEEING
336	BEA06	BHOIR SHUBHAM HEMANT	CIVIL ENGINEEING
337	BEA07	BHOPI ROHAN RAGHUNATH	CIVIL ENGINEEING
338	BEA08	CHAVAN SANKET SURESH	CIVIL ENGINEEING
339	BEA09	CHAVAN VIKAS NAMDEV PURLABAI	CIVIL ENGINEEING
340	BEA10	CHIMANE SANKET SANTOSH	CIVIL ENGINEEING
341	BEA11	CHITTE GAURAV VIKAS	CIVIL ENGINEEING
342	BEA12	DANDEKAR MILAN LALIT	CIVIL ENGINEEING
343	BEA13	DEOKAR YOGESH PITAMBAR	CIVIL ENGINEEING
344	BEA14	DESAI MANGESH PANDURANG	CIVIL ENGINEEING
345	BEA15	DESHMUKH MAYURI SANJAY CHITRA	CIVIL ENGINEEING
346	BEA16	DESHMUKH SANKET BAPURAO SARIKA	CIVIL ENGINEEING
347	BEA17	DHENDE MAYUR SIDDHARTH MINAKSHI	CIVIL ENGINEEING
348	BEA18	GADGE AKASH BABAJI SUGANDHA	CIVIL ENGINEEING
349	BEA19	GAIKWAD HARSHADA POPAT	CIVIL ENGINEEING
350	BEA20	GAVHANE RUSHIKESH NAMDEO	CIVIL ENGINEEING
351	BEA21	GAWADE ROHIT DEVAPPA	CIVIL ENGINEEING
352	BEA22	GAWAND NINAD RAVINDRA	CIVIL ENGINEEING
353	BEA23	GAWANDE SANJANA SHAILESH	CIVIL ENGINEEING
354	BEA24	GHANATE HARSHAL BABURAO	CIVIL ENGINEEING
355	BEA25	GHANGHAV HARSHVARDHAN MUKUND	CIVIL ENGINEEING
356	BEA26	GHRAT PRADNYA YASHAVANT	CIVIL ENGINEEING
357	BEA27	GODE ABHISHEK JAYDEEP	CIVIL ENGINEEING
358	BEA28	GURAV ADITYA ADESH	CIVIL ENGINEEING
359	BEA29	HEKRE SNEHAL SHARAD SUNITA	CIVIL ENGINEEING
360	BEA30	JADHAV AKASH ARUN	CIVIL ENGINEEING
361	BEA31	JADHAV ANIKET SATISH	CIVIL ENGINEEING
362	BEA32	JADHAV SAMEER RAJENDRA	CIVIL ENGINEEING
363	BEA33	JADHAV SWARAJ JAYANT	CIVIL ENGINEEING

TRUE COPY

[Signature]

Principal
Vishwaniketan's (i MEET)

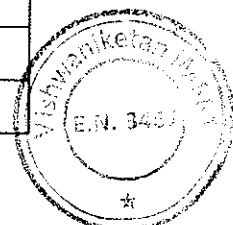

364	BEA34	JOSHI UDAY MAHESH	CIVIL ENGINEEING
365	BEA35	KADAM NIKHIL RAMA	CIVIL ENGINEEING
366	BEA36	KALE PRADEEP RAMCHANDRA	CIVIL ENGINEEING
367	BEA37	KANTHALE SHUBHAM DADANATH	CIVIL ENGINEEING
368	BEA38	KARNUK VRUSHALI RAMBHAJI	CIVIL ENGINEEING
369	BEA39	KAVALE SAURABH SURESH	CIVIL ENGINEEING
370	BEA40	KHAN SAJID AFZAL	CIVIL ENGINEEING
371	BEA41	KHEDEKAR SANKALP SHARAD	CIVIL ENGINEEING
372	BEA42	KHUTLE PRATIKESH JAGANNATH	CIVIL ENGINEEING
373	BEA43	KOKARE VISHAL BALU	CIVIL ENGINEEING
374	BEA44	KOLI ROHAN JAGAN	CIVIL ENGINEEING
375	BEA45	KOTHEKAR JANHAVI DATTATRAY	CIVIL ENGINEEING
376	BEA46	KULKARNI KAUSTUBH SACHIN	CIVIL ENGINEEING
377	BEA47	KULKARNI PARAG ANANT	CIVIL ENGINEEING
378	BEA48	KULKARNI SAMEER MAHESH	CIVIL ENGINEEING
379	BEA49	KURANGALE KIRAN KRUSHNA	CIVIL ENGINEEING
380	BEA50	MADANE NANDINI DILIP SUMAN	CIVIL ENGINEEING
381	BEA51	MADHAVI CHAITANYA KISHOR	CIVIL ENGINEEING
382	BEA52	MADHAVI TANMAY DNYANESHWAR	CIVIL ENGINEEING
383	BEA53	MADKE DARSHAN BHARAT	CIVIL ENGINEEING
384	BEA54	MADKE MRUNAL MALHARI	CIVIL ENGINEEING
385	BEA55	MAGAR PRADNESH PRAFULL VAISHALI	CIVIL ENGINEEING
386	BEA56	MAHABALE SATYAVAN VISHWANATH	CIVIL ENGINEEING
387	BEA57	MAHADIK CHAITANYA CHANDRAKANT LAXMI	CIVIL ENGINEEING
388	BEA58	MALI SAGAR SANTOSH ARCHANA	CIVIL ENGINEEING
389	BEA59	MHATRE BHUSHAN VISHWNATH	CIVIL ENGINEEING
390	BEA60	MHATRE DIKSHITA BALIRAM	CIVIL ENGINEEING
391	BEA61	MHATRE NISHANT CHANDRASHEKHAR ANITA	CIVIL ENGINEEING
392	BEA62	MHATRE PRATIK BHANUDAS	CIVIL ENGINEEING
393	BEA63	MHATRE SIDDHANT SANJAY	CIVIL ENGINEEING
394	BEA64	MHATRE VIPUL SHRIPAT	CIVIL ENGINEEING
395	BEB01	MOHITE MANSEE MOHAN	CIVIL ENGINEEING
396	BEB02	MOKAL HARSHADA VISHAVNATH	CIVIL ENGINEEING
397	BEB03	MOKAL PRAJWAL SUNIL	CIVIL ENGINEEING
398	BEB04	MOKAL SHUBHAM SANTOSH	CIVIL ENGINEEING
399	BEB05	MORE PRADIP SHRIRAM	CIVIL ENGINEEING
400	BEB06	MUJAWAR SALMAN TASLIM WAHIDA	CIVIL ENGINEEING

TRUE COPY

[Signature]
Principal

Vishwan Ketan's (PVT) LTD.

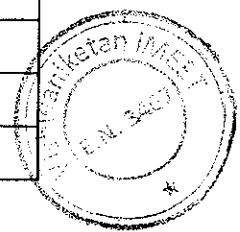

401	BEB07	MUKKU PRASHANTHAKUMAR VENKA	CIVIL ENGINEERING
402	BEB08	NAGDIVE NIVESH SUDHIR MRUDULA	CIVIL ENGINEERING
403	BEB09	NAIK JAYESH CHANDRAKANT	CIVIL ENGINEERING
404	BEB10	NARANGIKAR HARSHADA ANIL	CIVIL ENGINEERING
405	BEB11	NAVALE SANJEEVANI SURYAKANT	CIVIL ENGINEERING
406	BEB12	OJHA SANJEEVKUMAR TRILOCHAN	CIVIL ENGINEERING
407	BEB13	OSWAL DUSHANT MANISH	CIVIL ENGINEERING
408	BEB14	PADWANKAR SAURABH SANJAY	CIVIL ENGINEERING
409	BEB15	PANDHARE RUSHIKESH DNYANDEV	CIVIL ENGINEERING
410	BEB16	PATIL AARTI PRALHAD	CIVIL ENGINEERING
411	BEB17	PATIL HARSHAD RAMDAS SUREKHA	CIVIL ENGINEERING
412	BEB18	PATIL KEDAR SHARAD REKHA	CIVIL ENGINEERING
413	BEB19	PATIL OMKAR KISHOR	CIVIL ENGINEERING
414	BEB20	PATIL OMKAR MADHUKAR	CIVIL ENGINEERING
415	BEB21	PATIL PRATIK NARAYAN	CIVIL ENGINEERING
416	BEB22	PATIL PRATIKSHA YASHWANT	CIVIL ENGINEERING
417	BEB23	PATIL RATNESH RAMAKANT	CIVIL ENGINEERING
418	BEB24	PATIL SAYALI ANIL	CIVIL ENGINEERING
419	BEB25	PATIL SAYLI KISHOR KALAVATI	CIVIL ENGINEERING
420	BEB26	PATIL SHUBHAM MOHAN	CIVIL ENGINEERING
421	BEB27	PATIL TEJAL VASUDEV	CIVIL ENGINEERING
422	BEB28	PATIL TEJASWINI VIKAS	CIVIL ENGINEERING
423	BEB29	PATIL UMANG DHANAJI	CIVIL ENGINEERING
424	BEB30	PETHE ANKIT RAJENDRA	CIVIL ENGINEERING
425	BEB31	PINGALE ROHINI SANTOSH	CIVIL ENGINEERING
426	BEB32	POKHARKAR NILESH RAMDAS	CIVIL ENGINEERING
427	BEB33	RANGARI VIPUL DEVANAND	CIVIL ENGINEERING
428	BEB34	SAITAWADEKAR SAURABH RAMESH	CIVIL ENGINEERING
429	BEB35	SALVI PRASENJIT RAJESH	CIVIL ENGINEERING
430	BEB36	SANAP ABHISHEK SHAILESH	CIVIL ENGINEERING
431	BEB37	SAPKAL PIYUSH RAJESH	CIVIL ENGINEERING
432	BEB38	SARDESAI DIGVIJAY CHANDRAKANT	CIVIL ENGINEERING
433	BEB39	SATVE AKSHAY ANANTA	CIVIL ENGINEERING
434	BEB40	SAVALE BHUPESH HIMMATRAO	CIVIL ENGINEERING
435	BEB41	SAWANT CHIRAG DEEPAK NARAYAN	CIVIL ENGINEERING
436	BEB42	SAWANT PRATIK JAGADISH	CIVIL ENGINEERING
437	BEB43	SHAH VISHESH SANDEEP	CIVIL ENGINEERING

TRUE COPY

[Signature]

Principal

Vishwaniketan's (IMET)

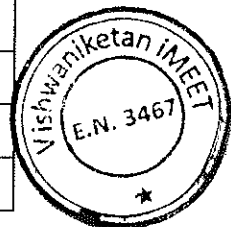

438	BEB44	SHAIKH RAHAMANSAB ABDUL	CIVIL ENGINEERING
439	BEB45	SHARMA VIKASH KUMAR	CIVIL ENGINEERING
440	BEB46	SHETE NIKHIL NAVIN	CIVIL ENGINEERING
441	BEB47	SHINDE ANKITA PRASHANT SAYALI	CIVIL ENGINEERING
442	BEB48	SHINDE VISHAL PRAKASH	CIVIL ENGINEERING
443	BEB49	SHIRKE ASHITOSH SURESH	CIVIL ENGINEERING
444	BEB50	SINGH SANJU ARUNKUMAR	CIVIL ENGINEERING
445	BEB51	SURYAWANSHI SIDDHANT BANDOPANT	CIVIL ENGINEERING
446	BEB52	THAKUR ABHISHEK ANIL	CIVIL ENGINEERING
447	BEB53	THAKUR OMKAR ANAND NILAM	CIVIL ENGINEERING
448	BEB54	THAKUR SARVESH CHANDRASHEKHAR GITAI	CIVIL ENGINEERING
449	BEB55	THAKUR SHILPA NARAYAN	CIVIL ENGINEERING
450	BEB56	THAKUR VAIBHAV PURUSHOTTAM	CIVIL ENGINEERING
451	BEB57	THAKUR VRUSHAL RAJESH	CIVIL ENGINEERING
452	BEB58	THUBE PRATIKSHA GITARAM	CIVIL ENGINEERING
453	BEB59	UGHADA VILAS DURGADAS	CIVIL ENGINEERING
454	BEB60	WAGH PANKAJ BALU	CIVIL ENGINEERING
455	BEB61	WAGHMARE BHAGYASHRI MOHAN	CIVIL ENGINEERING
456	BEB62	THORAT ROHIT KISHOR	CIVIL ENGINEERING
457	BEB63	WAKADE SNEHAL PRADEEP	CIVIL ENGINEERING
458	SCS01	AMRALE PRATHMESH SANJAY	COMPUTER ENGINEERING
459	SCS02	BHARMBE JAY ANIL	COMPUTER ENGINEERING
460	SCS03	CHAUDHARI AYUSH SUHAS	COMPUTER ENGINEERING
461	SCS04	CHOUDHARI SWAPNIL PURUSHOTTAM	COMPUTER ENGINEERING
462	SCS05	DALVI NIVEDITA YASHWANT	COMPUTER ENGINEERING
463	SCS06	DESHMUKH PUNYAK MANOJ	COMPUTER ENGINEERING
464	SCS07	DHANAWADE DHANASHREE HANAMANT	COMPUTER ENGINEERING
465	SCS08	DHAYGUDE AKSHAY SUDAM	COMPUTER ENGINEERING
466	SCS09	GAIKAR PRABODH NAMDEV	COMPUTER ENGINEERING
467	SCS10	GAJRE ABHIJEET AMRUT	COMPUTER ENGINEERING
468	SCS11	GAONKAR ANIKETH NARAYAN	COMPUTER ENGINEERING
469	SCS12	GAWADE PIYUSH SHRIKANT	COMPUTER ENGINEERING
470	SCS13	HOLKAR HITESH SATISH	COMPUTER ENGINEERING
471	SCS14	JADHAV TANMAY SANJAY	COMPUTER ENGINEERING
472	SCS15	JOSHI DHARMIK RAJESH	COMPUTER ENGINEERING
473	SCS16	KALEL OMKAR RAJARAM	COMPUTER ENGINEERING
474	SCS17	KATE ADITYA SUNIL	COMPUTER ENGINEERING



475	SCS18	KETKAR SHREYA CHANDRASHEKHAR	COMPUTER ENGINEERING
476	SCS19	KHALADKAR OMKAR SUDHIR	COMPUTER ENGINEERING
477	SCS20	KOLI ANUSHRI SUBHASH	COMPUTER ENGINEERING
478	SCS21	KULKARNI KIRTI RAHUL	COMPUTER ENGINEERING
479	SCS22	KULKARNI PAVAN GOVINDRAO	COMPUTER ENGINEERING
480	SCS23	KULKARNI SUSHIL VIJAYKUMAR	COMPUTER ENGINEERING
481	SCS24	MANE OMKAR ARVIND	COMPUTER ENGINEERING
482	SCS25	MANE RUTVIJ MAHENDRA	COMPUTER ENGINEERING
483	SCS26	MANKAWLE DISHA RAJENDRA	COMPUTER ENGINEERING
484	SCS27	MISHRA DHRUVKUMAR ANUSUYAPRASAD	COMPUTER ENGINEERING
485	SCS28	MISHRA PRATIK AWADHESH	COMPUTER ENGINEERING
486	SCS29	MORE JATIN SUNIL	COMPUTER ENGINEERING
487	SCS30	MULIK DIKSHA DILIP	COMPUTER ENGINEERING
488	SCS31	NAIK PRAGATI GOPAL	COMPUTER ENGINEERING
489	SCS32	NARAYANKAR CHAITANYA DUDAMBHAI	COMPUTER ENGINEERING
490	SCS33	NARENDRAGURU HARIKRISHNAN	COMPUTER ENGINEERING
491	SCS34	NARHARSHETTIWAR ATHARV ANIL	COMPUTER ENGINEERING
492	SCS35	NARWADE SHYAMAL SANJAY	COMPUTER ENGINEERING
493	SCS36	NIDHI PANKAJ SANTOSH	COMPUTER ENGINEERING
494	SCS37	PATIL DHANASHREE DHANANJAY	COMPUTER ENGINEERING
495	SCS38	PATIL MAHESH BALKRISHNA	COMPUTER ENGINEERING
496	SCS39	PATIL MAMATA SANJAY	COMPUTER ENGINEERING
497	SCS40	PATIL MRUNALI BABAN	COMPUTER ENGINEERING
498	SCS41	PATIL RUTUJA SUJITKUMAR	COMPUTER ENGINEERING
499	SCS42	PATIL SARVESH PRAVIN	COMPUTER ENGINEERING
500	SCS43	PATIL SHRUTI KISHOR	COMPUTER ENGINEERING
501	SCS44	PATIL SWAPNIL MOHANDAS	COMPUTER ENGINEERING
502	SCS45	PATIL TRUPTI PRAVIN	COMPUTER ENGINEERING
503	SCS46	PINGALE KALYANI RAJENDRA	COMPUTER ENGINEERING
504	SCS47	RAJADHYAKSHA PRASAD SHANTARAM	COMPUTER ENGINEERING
505	SCS48	RAUT RUTURAJ SANJAY	COMPUTER ENGINEERING
506	SCS49	SAWANT ASHUTOSH ARUN	COMPUTER ENGINEERING
507	SCS50	SHARMA RITIK DEVIDAYAL	COMPUTER ENGINEERING
508	SCS51	SHIMPI SHIVANI AMOL	COMPUTER ENGINEERING
509	SCS52	SHINDE AVDHUT SHRIHARI	COMPUTER ENGINEERING
510	SCS53	SHRINAGARWAR VAIBHAV PRAVIN	COMPUTER ENGINEERING
511	SCS54	SINGH ARJUN OMPRAKASH	COMPUTER ENGINEERING



512	SCS55	SINGH MUSKAN VIJAY	COMPUTER ENGINEERING
513	SCS56	SINGH RITIKA PRADEEP	COMPUTER ENGINEERING
514	SCS57	SINGH RITU NAGENDRA	COMPUTER ENGINEERING
515	SCS58	SINGH SRIJAN SANTOSH KUMAR	COMPUTER ENGINEERING
516	SCS59	TEMBHRE HARSHAD RAMESH	COMPUTER ENGINEERING
517	SCS60	TERDE JATIN YOGESH	COMPUTER ENGINEERING
518	SCS61	UCHIL SAMRUDH SUSHANT	COMPUTER ENGINEERING
519	SCS62	VICHARE SHRUTI SUDHIR	COMPUTER ENGINEERING
520	SCS63	VIDWANS AJINKYA DILEEP	COMPUTER ENGINEERING
521	SCS64	WAVEKAR SUJAN SUNIL	COMPUTER ENGINEERING
522	TE01	BHADANE GAURAV BHAYYASAHEB	COMPUTER ENGINEERING
523	TE02	BHAGAT SIDDHI RAMAKANT	COMPUTER ENGINEERING
524	TE03	BHOSALE ANURAJ CHANDRAKANT	COMPUTER ENGINEERING
525	TE04	DESHMUKH PRATIK DNYANESHWAR	COMPUTER ENGINEERING
526	TE05	DHAKANE SACHIN SANJAY	COMPUTER ENGINEERING
527	TE06	DONGRE KRISHNAM AKSHAY	COMPUTER ENGINEERING
528	TE07	GAWADE SAMRUDDHI SANTOSH	COMPUTER ENGINEERING
529	TE08	GURAV SAMIKSHA MAHESH	COMPUTER ENGINEERING
530	TE09	HEGDE SUDEEP DEEPAK	COMPUTER ENGINEERING
531	TE10	HUDGI GURURAJ MALLIKARJUN	COMPUTER ENGINEERING
532	TE11	JAPE SUPRIYA BABAN	COMPUTER ENGINEERING
533	TE12	JOSHI VENKATESH ARUN	COMPUTER ENGINEERING
534	TE13	JUIKAR RIYA HEMANT	COMPUTER ENGINEERING
535	TE14	KALBHOR SUMIT SUBHASH	COMPUTER ENGINEERING
536	TE15	KANSE KIRAN MAHADEV	COMPUTER ENGINEERING
537	TE16	KAPSE AJINKYA CHANDRAKANT	COMPUTER ENGINEERING
538	TE17	KAWALE SWAGATA NITESH	COMPUTER ENGINEERING
539	TE18	KHOPADE SWARAJ SHRIDHAR	COMPUTER ENGINEERING
540	TE19	KOLPE HRISHIKESH	COMPUTER ENGINEERING
541	TE20	KUNTE HARSH DEEPAK	COMPUTER ENGINEERING
542	TE21	MAHTO DIYA DINESHKUMAR	COMPUTER ENGINEERING
543	TE22	MALKAR MANASI DINESH	COMPUTER ENGINEERING
544	TE23	MHATRE RASHMI UPENDRA	COMPUTER ENGINEERING
545	TE24	MHATRE UPASANA SHIVDAS	COMPUTER ENGINEERING
546	TE25	MOKAL KARISHMA GAJANAN	COMPUTER ENGINEERING
547	TE26	MOKAL VAISHNAVI PRABHAKAR	COMPUTER ENGINEERING
548	TE27	MOURYA ANKITA HIRA	COMPUTER ENGINEERING

TRUE COPY

[Signature]
Principal
Vishwaniketan's (I.M.E.E.T)

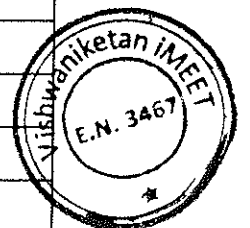

549	TE	NALAGE CHAITANYA GANPAT	COMPUTER ENGINEERING
550	TE	NANDGAONKAR SHARVARI RAJENDRA	COMPUTER ENGINEERING
551	TE	PATIL DHANSHREE SUBILASHI	COMPUTER ENGINEERING
552	TE	PATIL JAYESH HIRALAL	COMPUTER ENGINEERING
553	TE	PATIL PURNIMA RAJENDRA	COMPUTER ENGINEERING
554	TE	PATIL SIDDHESH SAMBHAJI	COMPUTER ENGINEERING
555	TE	PATOLE NUTAN UTTAM	COMPUTER ENGINEERING
556	TE	PAWAR MANSI JAYAWANT	COMPUTER ENGINEERING
557	TE	PAWAR SONIKA SAMPAT	COMPUTER ENGINEERING
558	TE	RAUT NEHA ANIL	COMPUTER ENGINEERING
559	TE	SHAIKH RAHAT HAMID	COMPUTER ENGINEERING
560	TE	SHELAR NAJUKA DINESH	COMPUTER ENGINEERING
561	TE	SHELKE AJAY MANOHAR	COMPUTER ENGINEERING
562	TE	SHUKLA VISHAL ANJANI	COMPUTER ENGINEERING
563	TE	SOMWANSHI ANIKET ASHOK	COMPUTER ENGINEERING
564	TE	THALE VAISHNAVI DINESH	COMPUTER ENGINEERING
565	TE	THORAT PRATYUSH	COMPUTER ENGINEERING
566	TE	UGALE JANHAVI MADHUKAR	COMPUTER ENGINEERING
567	TE	UPADHYAY TIRTH JAYESH	COMPUTER ENGINEERING
568	TE	VISHWAKARMA AJAY RAMHARSH	COMPUTER ENGINEERING
569	TE	ZALTE RAVINA VIITHAL	COMPUTER ENGINEERING
570	TE	ABHANG SHRUTI TANAJI	COMPUTER ENGINEERING
571	TE	BHALERAO PRATIK PANDURANG	COMPUTER ENGINEERING
572	TE	BHOLE YASH VILAS	COMPUTER ENGINEERING
573	TE	BURANGE POONAM GOVIND	COMPUTER ENGINEERING
574	TE	DESHPANDE SUTEJ SUNIL	COMPUTER ENGINEERING
575	TE	HINDLEKAR HRISHIKESH VIJAY	COMPUTER ENGINEERING
576	TE	JADHAV AKASH BALASAHEB	COMPUTER ENGINEERING
577	TE	KADAM PRANALI DILIP	COMPUTER ENGINEERING
578	TE	MISHRA NEHA DIGVIJAY	COMPUTER ENGINEERING
579	TE	MISTRY JYOTI DEBIDAS	COMPUTER ENGINEERING
580	TE	PATEL NARESH KANARAM	COMPUTER ENGINEERING
581	TE	RAWATE AASHUTOSH KAILAS	COMPUTER ENGINEERING
582	TE	RAY APRATIM ACHINTYA	COMPUTER ENGINEERING
583	TE	SASANE DAKSHATA SANJAU	COMPUTER ENGINEERING
584	TE	SATHE SUCHITRA SURESH	COMPUTER ENGINEERING
585	TE	SINGH ROSHANI FIRNATH	COMPUTER ENGINEERING

TRUE COPY

[Signature]
Principal

Vishwaniketan's (MEET)

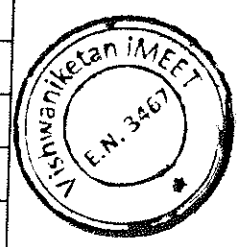

586	TE65*	SINGH SAMIKSHA PRATAP	COMPUTER ENGINEERING
587	TE66*	TANDEL AATISH	COMPUTER ENGINEERING
588	TE67*	TELANGI ADITYA PRAFULLI	COMPUTER ENGINEERING
589	TE68*	THALE SRUSHITI NAYAN	COMPUTER ENGINEERING
590	TE69*	THORAT PRATIKSHA YASHWANT	COMPUTER ENGINEERING
591	TE70*	VELE DEVEN P	COMPUTER ENGINEERING
592	TE71*	WAKDE SHIRIN SUBHASH	COMPUTER ENGINEERING
593	BE01	ANANDRAO SACHIN BHIMRAO	COMPUTER ENGINEERING
594	BE02	ANCHALKAR TANMAY UMESH	COMPUTER ENGINEERING
595	BE03	ATTAR NAMRA IQBAL	COMPUTER ENGINEERING
596	BE04	BURUMKAR SWEETY SANJAY	COMPUTER ENGINEERING
597	BE05	CHAVAN SONAL SUHAS	COMPUTER ENGINEERING
598	BE06	CHIKHALEKAR SNEHANKI JANARDAN	COMPUTER ENGINEERING
599	BE07	CHOURASIYA PAWANKUMAR S	COMPUTER ENGINEERING
600	BE08	DALAL PRATHAMESH MANGESH	COMPUTER ENGINEERING
601	BE09	DESHMUKH SAGAR JAGDISH	COMPUTER ENGINEERING
602	BE10	GAIKWAD PRANAY PRAKASHI	COMPUTER ENGINEERING
603	BE11	GAWAS SONALI RAMKRISHNA	COMPUTER ENGINEERING
604	BE12	GUPTA PRATIK MAHESH	COMPUTER ENGINEERING
605	BE13	GUPTA SUJITKUMAR SANTOSH	COMPUTER ENGINEERING
606	BE14	KADAM SHAILESH PRAKASH	COMPUTER ENGINEERING
607	BE15	KANASE ABHISHEK ASHOK	COMPUTER ENGINEERING
608	BE16	KAPASE TEJASHREE ARUN	COMPUTER ENGINEERING
609	BE17	KULKARNI NARAYAN RAJESHWAR	COMPUTER ENGINEERING
610	BE18	KUMAR SONAL ARUN	COMPUTER ENGINEERING
611	BE19	LAMTURE SIMRAN JAHANGIR	COMPUTER ENGINEERING
612	BE20	MANE DEEPALI GOPAL	COMPUTER ENGINEERING
613	BE21	MHATRE TRIVENI PARSHURAM	COMPUTER ENGINEERING
614	BE22	MHATRE VAIBHAV NARESH	COMPUTER ENGINEERING
615	BE23	MOKAL GUNVANT VITTHAL	COMPUTER ENGINEERING
616	BE24	PALANDE AVDHUT ATUL	COMPUTER ENGINEERING
617	BE25	PATIL AMEY ANKUSH	COMPUTER ENGINEERING
618	BE26	PATIL MANASI JAGGNATH	COMPUTER ENGINEERING
619	BE27	PATIL MONALI HARISHCHANDRA	COMPUTER ENGINEERING
620	BE28	PATIL SWAPNIL RAMCHANDRA	COMPUTER ENGINEERING
621	BE29	PAWAR SAMRUDDHI SANJAY	COMPUTER ENGINEERING
622	BE30	PAWAR SAURABH SURENDRA	COMPUTER ENGINEERING

TRUE COPY

[Handwritten Signature]

Principal

Vishwaniketan's (I.M.E.E.T)

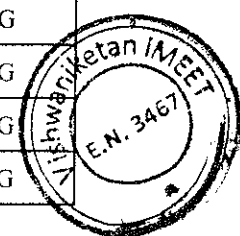

623	BE31	POOJARY ABHISHEK RAVI	COMPUTER ENGINEERING
624	BE32	RAI SAIPRASAD MANHOR	COMPUTER ENGINEERING
625	BE33	RAJPUT RITENDRAPRATAPSINGH J	COMPUTER ENGINEERING
626	BE34	SANGHAVI MAYANK ATUL	COMPUTER ENGINEERING
627	BE35	SARANG DHIRAJ DNYANRAJ	COMPUTER ENGINEERING
628	BE36	SAWANT SIDDESH LASHOK	COMPUTER ENGINEERING
629	BE37	SAYYED ALFIYA RASHID	COMPUTER ENGINEERING
630	BE38	SHARMA DEEPIKA BHAGWAN	COMPUTER ENGINEERING
631	BE39	SHINDE VISHAL SATISH	COMPUTER ENGINEERING
632	BE40	SHINGARE PRASHANT DEEPAK	COMPUTER ENGINEERING
633	BE41	SINGH RUPESHKUMAR NARENDRA	COMPUTER ENGINEERING
634	BE42	TARANGE HARSHADA PRATAP	COMPUTER ENGINEERING
635	BE43	THETE PARMESHVAR BABRUVAN	COMPUTER ENGINEERING
636	BE44	VAVIYA ANAND BECHARABAI	COMPUTER ENGINEERING
637	BE45	VERMA SANDEEP SURENDRA	COMPUTER ENGINEERING
638	BE46	VINJAMURI VEDHAS SESHASAI	COMPUTER ENGINEERING
639	BE47*	CHAVAN OMKAR TANAJI	COMPUTER ENGINEERING
640	BE48*	CHAVAN VIKRAM NAMDEV	COMPUTER ENGINEERING
641	BE49*	DABHADE PRATIKSHA SARJERAO	COMPUTER ENGINEERING
642	BE50*	DALVI JIVITESH	COMPUTER ENGINEERING
643	BE51*	DALVI SAURABH GAJANAN	COMPUTER ENGINEERING
644	BE52*	DANDEKAR SNEHAL RAJENDRA	COMPUTER ENGINEERING
645	BE53*	DHANWADE MEGHA SHIVRAM	COMPUTER ENGINEERING
646	BE54*	GALAVE SAGAR SHANKAR	COMPUTER ENGINEERING
647	BE55*	GHARAT SANDESH BHARAT	COMPUTER ENGINEERING
648	BE56*	GURAV KOMAL RAVINDRA	COMPUTER ENGINEERING
649	BE57*	JADHAV SHRADDHA SHITAL	COMPUTER ENGINEERING
650	BE58*	KAKADE AISHWARYA SATISH	COMPUTER ENGINEERING
651	BE59*	KALE MONIKA DEVAJI	COMPUTER ENGINEERING
652	BE60*	KHEDKAR AISHWARYA RAJENDRA	COMPUTER ENGINEERING
653	BE61*	LOHAR AISHWARYA MAHADEO	COMPUTER ENGINEERING
654	BE62*	MALI MAYURI MAHENDRA	COMPUTER ENGINEERING
655	BE63*	MASANE GAURI DATTATREY	COMPUTER ENGINEERING
656	BE64*	PANDEY VISHANT RAMESHWAR	COMPUTER ENGINEERING
657	BE65*	PATIL JAGRUTI ANIL	COMPUTER ENGINEERING
658	BE66*	PATIL JYOTI RAMESH	COMPUTER ENGINEERING
659	BE67*	PATIL KUNAL VIJAY	COMPUTER ENGINEERING

TRUE COPY

[Signature]

Principal

Vishwaniketan's (I MEET)

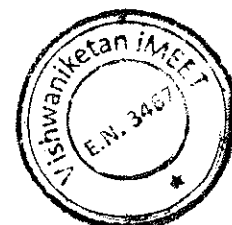

660	BE68*	PATIL NEHA RAJESH	COMPUTER ENGINEERING
661	BE69*	PATIL RUTUJA ANKUSH	COMPUTER ENGINEERING
662	BE70*	PATIL TEJAS BALU	COMPUTER ENGINEERING
663	BE71*	PAWAR PRIYA SANDEEP	COMPUTER ENGINEERING
664	BE72*	PUJARI AISHWARYA SHIVAJI	COMPUTER ENGINEERING
665	BE73*	SANKPAL ASHISH SHANKAR	COMPUTER ENGINEERING
666	BE74*	SHEWALE SHUBHAM LAXMAN	COMPUTER ENGINEERING
667	BE75*	SURYAVANSHI VINAYAK MANOJ	COMPUTER ENGINEERING
668	BE76*	SURYAWANSHI RAHUL	COMPUTER ENGINEERING
669	BE77*	THAKUR NIKITA JAGDISH	COMPUTER ENGINEERING
670	BE78*	THONGE VISHAKHA VIKAS	COMPUTER ENGINEERING
671	SE01	AMBAVANE GAURAV GANESH GAYATRI	ELECTRICAL ENGINEERING
672	SE02	BANDRE ANIKET ANIL ARCHANA	ELECTRICAL ENGINEERING
673	SE03	BARVE ANIKET ANIL SHAILA	ELECTRICAL ENGINEERING
674	SE04	BHONKAR SUBHAV VILAS VARSHA	ELECTRICAL ENGINEERING
675	SE05	BHOSALE PRATHMESH SURYAKANT SUNITA	ELECTRICAL ENGINEERING
676	SE06	BURUMKAR AMOL HARISHCHANDRA HARSH	ELECTRICAL ENGINEERING
677	SE07	CHAUDHARI NAYAN KACHARU LALITA	ELECTRICAL ENGINEERING
678	SE08	CHAUDHARI VARAD JAYESH POOJA	ELECTRICAL ENGINEERING
679	SE09	DAS ANINDYA TAPAN KRISHNA	ELECTRICAL ENGINEERING
680	SE10	DESHMUKH SAURAV BABAN VANITA	ELECTRICAL ENGINEERING
681	SE11	DEWARDE SHRUTIKA ANAND VANDANA	ELECTRICAL ENGINEERING
682	SE12	GADAMALE RONIT DASHARATH DARSHANA	ELECTRICAL ENGINEERING
683	SE13	GADGE PRESBIT PRAKASH RANJANA	ELECTRICAL ENGINEERING
684	SE14	GAIKAR JAY RAVINDRA SARITA	ELECTRICAL ENGINEERING
685	SE15	GAIKWAD OMKAR BALKRISHNA SANGITA	ELECTRICAL ENGINEERING
686	SE16	GUPTA RAVIKUMAR SURENDRANATH BADAM	ELECTRICAL ENGINEERING
687	SE17	GUPTE RAKESH UTTAM AMBIKA	ELECTRICAL ENGINEERING
688	SE18	KAMBLE SUMEDH BHASKAR SMITA	ELECTRICAL ENGINEERING
689	SE19	KANITKAR PRATIK PANDURANG KARUNA	ELECTRICAL ENGINEERING
690	SE20	KARALE NAYAN ARVIND ANJALI	ELECTRICAL ENGINEERING
691	SE21	KATHAVALE GURUNATH DEEPAK MANTHAN	ELECTRICAL ENGINEERING
692	SE22	KHAIR ROHAN RAJENDRA SHARADA	ELECTRICAL ENGINEERING
693	SE23	KHANDEKAR TANMAY DNYANESHWAR PUSHE	ELECTRICAL ENGINEERING
694	SE24	KHISMATRAO PRASAD SHAILESH SHEETAL	ELECTRICAL ENGINEERING
695	SE25	KHOPKAR SONALI AVINASH AMITA	ELECTRICAL ENGINEERING
696	SE26	KOLI DIVYESH CHANDRAKANT SHOBHA	ELECTRICAL ENGINEERING

TRUE COPY



[Signature]
Principal
Vishwaniketan's (I) MEET

697	SE27	KOTWADKAR RAKIB MOHSIN SHAMILA	ELECTRICAL ENGINEERING
698	SE28	LIMAYE MIHIR MANDAR MINAL	ELECTRICAL ENGINEERING
699	SE29	MHATRE PRASAD SANDIP SAMPADA	ELECTRICAL ENGINEERING
700	SE30	MHATRE PRATHAMESH PRAFULLA PRAGATI	ELECTRICAL ENGINEERING
701	SE31	MHATRE SNEHA GANESH MINAKSHI	ELECTRICAL ENGINEERING
702	SE32	MORE ABHAY BALASAHEB PRAFULATA	ELECTRICAL ENGINEERING
703	SE33	MUNE AKASH DASHRATH SUGANDHA	ELECTRICAL ENGINEERING
704	SE34	NADKAR SIWETA ANANT ANITA	ELECTRICAL ENGINEERING
705	SE35	NAGARKAR NAMRATA CHINTAMAN VIJAYA	ELECTRICAL ENGINEERING
706	SE36	NALAVADE SURAJ SUNIL ASHA	ELECTRICAL ENGINEERING
707	SE37	NARE KIRAN BHALCHANDRA BHARATI	ELECTRICAL ENGINEERING
708	SE38	NIMBALE SANDESH SHANKAR ALKA	ELECTRICAL ENGINEERING
709	SE39	PADELKAR AMIT SHANKAR SHALAKA	ELECTRICAL ENGINEERING
710	SE40	PATIL ANKITA NANDKUMAR SANGITA	ELECTRICAL ENGINEERING
711	SE41	PATIL MANJUL VINOD PRASHALI	ELECTRICAL ENGINEERING
712	SE42	PATIL NIKHIL BALIRAM RANJANA	ELECTRICAL ENGINEERING
713	SE43	PATIL PAVAN JANARDAN HARSHADA	ELECTRICAL ENGINEERING
714	SE44	PATIL PRATHAMESH NANDAKUMAR DRAUPA	ELECTRICAL ENGINEERING
715	SE45	PATIL ROHAN MARUTI MANGAL	ELECTRICAL ENGINEERING
716	SE46	PATIL SHUBHAM DATTATREY SANGITA	ELECTRICAL ENGINEERING
717	SE47	PATIL SHUBHAM KIRAN KAVITA	ELECTRICAL ENGINEERING
718	SE48	PATIL VISHAL VASUDEV SHUBHANGI	ELECTRICAL ENGINEERING
719	SE49	PAWAR AISHWARYA PRADEEP VAISHALI	ELECTRICAL ENGINEERING
720	SE50	PHIRANGE VISHAL BHAU SUNANDA	ELECTRICAL ENGINEERING
721	SE51	PIMPALKAR DIPIKA NANDKUMAR PRAGATI	ELECTRICAL ENGINEERING
722	SE52	RATHOD ADARSH ARVIND SHILABAI	ELECTRICAL ENGINEERING
723	SE53	SAKAT AJAY KUNDLIK MANISHA	ELECTRICAL ENGINEERING
724	SE54	SALPE ABHISHEK ANANT ASMITA	ELECTRICAL ENGINEERING
725	SE55	SALUNKE SOHAM SAMEER SWAPNALI	ELECTRICAL ENGINEERING
726	SE56	SANAS HARSHAD MADHUKAR SAVITA	ELECTRICAL ENGINEERING
727	SE57	SATVE VAISHNAV BALU MILAN	ELECTRICAL ENGINEERING
728	SE58	SHAIKH AADIL SHAHID RESHMA	ELECTRICAL ENGINEERING
729	SE59	SHENDAGE SANKET ANANDA VAISHALI	ELECTRICAL ENGINEERING
730	SE60	SHINDE KALPESH PARSHURAM MANDA	ELECTRICAL ENGINEERING
731	SE61	SHINDE KAUSHAL RUPESH RANE	ELECTRICAL ENGINEERING
732	SE62	SHINGARE ADITYA SHRIKANT BHAGYASHRI	ELECTRICAL ENGINEERING
733	SE63	SHIRKE ANIKET HARISHCHANDRA ARCHANA	ELECTRICAL ENGINEERING



TRUE COPY

BDP

Principal

Vishwaniketan's (I MEET)

734	SE64	SONAR RUSHIKESH ANIL SHITAL	ELECTRICAL ENGINEERING
735	SE65	UPADHAYA SUNIL SHAMBHUNATH MADHU	ELECTRICAL ENGINEERING
736	SE66	VEDPATHAK OMKAR KIRTIKUMAR SWATI	ELECTRICAL ENGINEERING
737	SE67	WAGH UMESH BABAN KAMAL	ELECTRICAL ENGINEERING
738	SE68	YADAV AKSHAY ANIL SAVITA	ELECTRICAL ENGINEERING
739	SE69	YAMDAGNI PRITHVIRAJ DURGESHI	ELECTRICAL ENGINEERING
740	TE01	BANGAR AKASH ARJUN SAUBAI	ELECTRICAL ENGINEERING
741	TE02	BENDRE ANIKET PRATAP VANDANA	ELECTRICAL ENGINEERING
742	TE03	BHAGAT ANUSHKA VINOD VINITA	ELECTRICAL ENGINEERING
743	TE04	BHOIR NARAYAN PUNDLIK JIJABAI	ELECTRICAL ENGINEERING
744	TE05	CHAKRABORTY NISHANT PARTHA RITA	ELECTRICAL ENGINEERING
745	TE06	CHAVAN OMKAR LAXMAN SUJATA	ELECTRICAL ENGINEERING
746	TE07	CHOUDHARI SAYALI SUNIL SHWETA	ELECTRICAL ENGINEERING
747	TE08	DAHIMBEKAR TEJAL ANIL ANKITA	ELECTRICAL ENGINEERING
748	TE09	DALE ROHAN RAJESH	ELECTRICAL ENGINEERING
749	TE10	DALVI SAYALI RAMESH	ELECTRICAL ENGINEERING
750	TE11	DAREKAR AVINASH SUBHASH LATA	ELECTRICAL ENGINEERING
751	TE12	DESHMUKH TUSHAR VIJAY	ELECTRICAL ENGINEERING
752	TE13	DHAPATE SWAPNIL CHANDRASEN SAVITA	ELECTRICAL ENGINEERING
753	TE14	DHURI YOGITA KAMALAKAR KAMALAKAR	ELECTRICAL ENGINEERING
754	TE15	GAIKWAD VIJAY SHIVAJI	ELECTRICAL ENGINEERING
755	TE16	GHANVAT AMIT MARUTI SUJATA	ELECTRICAL ENGINEERING
756	TE17	GHARAT VINAYA SANDESH SAVITA	ELECTRICAL ENGINEERING
757	TE18	GHORPADE ABHIJEET SAMBHAJI ARUNA	ELECTRICAL ENGINEERING
758	TE19	GHUME SHREENIVAS BALAJI LATA	ELECTRICAL ENGINEERING
759	TE20	GOYAL PRUTHVI SHIVRAM	ELECTRICAL ENGINEERING
760	TE21	HUKE SUPRAJ SUBODH PRAGATI	ELECTRICAL ENGINEERING
761	TE22	JADHAV MAYUR MANOJ SHWETA	ELECTRICAL ENGINEERING
762	TE23	JADHAV OMKAR MARUTI LAXMI	ELECTRICAL ENGINEERING
763	TE24	JOSHI SHRUTI SUDHIR SANGITA	ELECTRICAL ENGINEERING
764	TE25	KASARE SAGAR DILIP SHRADDHA	ELECTRICAL ENGINEERING
765	TE26	LADGE ANUJA DHANANJAY SAROJI	ELECTRICAL ENGINEERING
766	TE27	LANDGE SHRADDHA BHASKAR SHREEYA	ELECTRICAL ENGINEERING
767	TE28	MADAN PALLAVI BABURAO SHASHEKALA	ELECTRICAL ENGINEERING
768	TE29	MAHATO KRISHNA SANAT LALI	ELECTRICAL ENGINEERING
769	TE30	MALI HARSHALI PRABHAKAR MANISHA	ELECTRICAL ENGINEERING
770	TE31	MHATRE DIKSHA MAHADEV UMA	ELECTRICAL ENGINEERING

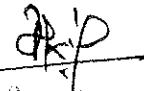

TRUE COPY

 Principal
 Vishwaniketan's (I.M.E.E.T)

771	TE32	MIATRE SIDDHESH DEVIDAS	ELECTRICAL ENGINEERING
772	TE33	MISHRA KARUNANAND MANOJ RAJKUMAR	ELECTRICAL ENGINEERING
773	TE34	MOKAL NISHANT KRISHNA VANDANA	ELECTRICAL ENGINEERING
774	TE35	NARAYANKAR RISHABH BHASKAR RANJANA	ELECTRICAL ENGINEERING
775	TE36	NHAVKAR NIRANJAN NAMDEV POOJA	ELECTRICAL ENGINEERING
776	TE37	PADALKAR PRA'IK PANDURANG SULBHA	ELECTRICAL ENGINEERING
777	TE38	PARTHE VAIBHAV VIJAY UJWALA	ELECTRICAL ENGINEERING
778	TE39	PATHARE DARSHAN SURESH DAYA	ELECTRICAL ENGINEERING
779	TE40	PATIL AJAY DILIP DIPALI	ELECTRICAL ENGINEERING
780	TE41	PATIL ASMIT KAILAS ARCHANA	ELECTRICAL ENGINEERING
781	TE42	PATIL HARSHAL SADANAND PUSHPA	ELECTRICAL ENGINEERING
782	TE43	PATIL MAHENDRA CHHOTULAL ASHA	ELECTRICAL ENGINEERING
783	TE44	PATIL NAYAN GOPINATH KALPANA	ELECTRICAL ENGINEERING
784	TE45	PATIL NIHAR SANJAY NAYNA	ELECTRICAL ENGINEERING
785	TE46	PATIL SAHIL SOPAN DHARTI	ELECTRICAL ENGINEERING
786	TE47	PATIL SHRADDHA RAMESH SUGANDHA	ELECTRICAL ENGINEERING
787	TE48	PATIL SHUBHAM HARIBHAU VIJAYA	ELECTRICAL ENGINEERING
788	TE49	PATIL SIDDESH KESARINATH KIRTI	ELECTRICAL ENGINEERING
789	TE50	PATIL VISHANT DEVIDAS PAVITA	ELECTRICAL ENGINEERING
790	TE51	PAWAR NITESH BHIMRAO ANITA	ELECTRICAL ENGINEERING
791	TE52	PHADKE AMEYA ANAND AARATI	ELECTRICAL ENGINEERING
792	TE53	SABLE OMKAR PRAVIN SUJATA	ELECTRICAL ENGINEERING
793	TE54	SALUNKHE SURAJ SUBHASH VANDANA	ELECTRICAL ENGINEERING
794	TE55	SALUNKHE TEJAS HANUMANT RANJANA	ELECTRICAL ENGINEERING
795	TE56	SHELKE RAVI KANU SANGITA	ELECTRICAL ENGINEERING
796	TE57	SHIRKE KALPESH ANKUSH ASHWINI	ELECTRICAL ENGINEERING
797	TE58	SUTAR SHUBHAM SHASHIKANT SHOBHA	ELECTRICAL ENGINEERING
798	TE59	TANDEL PANKAJ DHANAJI PRATIKSHA	ELECTRICAL ENGINEERING
799	TE60	TARU AMEY RAVINDRA SUNITA	ELECTRICAL ENGINEERING
800	TE61	THAKUR AKHIL VIDYADHAR RAJESHREE	ELECTRICAL ENGINEERING
801	TE62	THAKUR BHAVANA DHANAJI DHANASHREE	ELECTRICAL ENGINEERING
802	TE63	THAKUR RAHUL RAMESH SHUBHANGI	ELECTRICAL ENGINEERING
803	TE64	THALE SHREYAS SHRIKANT SHRUTI	ELECTRICAL ENGINEERING
804	TE65	THALE TEJAL VIKAS NIKITA	ELECTRICAL ENGINEERING
805	TE66	TODANKAR VIPRESH DIGAMBAR DAKSHITA	ELECTRICAL ENGINEERING
806	TE67	TORASKAR TEJASHRI DASHARATH NIRMALA	ELECTRICAL ENGINEERING
807	TE68	TUPE BHAGYASHREE KASHINATH NISHA	ELECTRICAL ENGINEERING



TRUE COPY

[Handwritten Signature]
 Vishwaniketan Institute
 Warananagar

808	TE69	UBHARE SHREYA SANJAY SANJEEVANI	ELECTRICAL ENGINEERING
809	TE70	VAGHARE SWAGAT MANOHAR MADHURI	ELECTRICAL ENGINEERING
810	TE71	VARTAK AKASH KISHOR PRAMILA	ELECTRICAL ENGINEERING
811	TE72	WADAL PARAS DATTATREY GEETA	ELECTRICAL ENGINEERING
812	TE73	WASAVE SURAJ BHIMA MANISHA	ELECTRICAL ENGINEERING
813	BE01	AMBAVANE AMRUTA MANOJ	ELECTRICAL ENGINEERING
814	BE02	ANDHERE SHUBHAM DEVENDRA	ELECTRICAL ENGINEERING
815	BE03	AWASKAR ROSHAN HIRAMAN	ELECTRICAL ENGINEERING
816	BE04	BAILMARE SAMIDHA RAVINDRA	ELECTRICAL ENGINEERING
817	BE05	BHOIR PRATHAMESH PARSHURAM	ELECTRICAL ENGINEERING
818	BE06	BHOIR SHIVANI MAHESH	ELECTRICAL ENGINEERING
819	BE07	BHOPI NIKHIL BHAGVAN	ELECTRICAL ENGINEERING
820	BE08	BHOWATE PRANALI RAMA VIDYA	ELECTRICAL ENGINEERING
821	BE09	BIDRE PRASAD DILIP	ELECTRICAL ENGINEERING
822	BE10	CHAVAN AJAY SHIVAJI	ELECTRICAL ENGINEERING
823	BE11	DALVI RUSHIKESH NARESH	ELECTRICAL ENGINEERING
824	BE12	DESHMUKH VAIBHAV HARISHCHANDRA	ELECTRICAL ENGINEERING
825	BE13	DHAYAGUDE KUNAL RAVINDRA	ELECTRICAL ENGINEERING
826	BE14	DHUMAL MANOHAR ASHOK	ELECTRICAL ENGINEERING
827	BE15	FOFERKAR PRANAY VILAS PRAFULLA	ELECTRICAL ENGINEERING
828	BE16	GADE PRATIK SAVLARAM	ELECTRICAL ENGINEERING
829	BE17	GAMBHIR SAURABH VISHWAS	ELECTRICAL ENGINEERING
830	BE18	GHARGE ARCHANA	ELECTRICAL ENGINEERING
831	BE19	GIRI ARATI NARENDRA SNEHA	ELECTRICAL ENGINEERING
832	BE20	JAITU ADITYA SUHAS BHARATI	ELECTRICAL ENGINEERING
833	BE21	JOSHI PRATIK MANOJ PADMAJA	ELECTRICAL ENGINEERING
834	BE22	JOSHI RAHUL SUDHAKAR	ELECTRICAL ENGINEERING
835	BE23	KANGE DIPTI LAXMAN SANGEETA	ELECTRICAL ENGINEERING
836	BE24	KOLEKAR BHAGYASHREE HARI	ELECTRICAL ENGINEERING
837	BE25	LOHAR AMISH VIJAY MANISHA	ELECTRICAL ENGINEERING
838	BE26	LOLE NIKITA SURESH	ELECTRICAL ENGINEERING
839	BE27	MANE DEVYANI SANJAY	ELECTRICAL ENGINEERING
840	BE28	MHASKE AKASH MHATARBA	ELECTRICAL ENGINEERING
841	BE29	MHATRE BHUSHAN RAMKRISHNA	ELECTRICAL ENGINEERING
842	BE30	MHATRE HARSHAD DATTATRAY	ELECTRICAL ENGINEERING
843	BE31	MHATRE RUCHITA KASHINATH	ELECTRICAL ENGINEERING
844	BE32	MHATRE SAGAR KASHINATH	ELECTRICAL ENGINEERING



TRUE COPY

[Signature]

Principal
Vishwaniketan's (i MEET)

845	BE33	MILATRE SHEKHAR KASHINATH	ELECTRICAL ENGINEERING
846	BE34	MOKAL DAKSHATA DASHARATH	ELECTRICAL ENGINEERING
847	BE35	MOKAL VAISHNAVI VISHWANATH	ELECTRICAL ENGINEERING
848	BE36	MORE SUMIT SUNIL	ELECTRICAL ENGINEERING
849	BE37	MUNDHE MAYUR BHIM	ELECTRICAL ENGINEERING
850	BE38	PATIL ABHILASH CHANDRAKANT	ELECTRICAL ENGINEERING
851	BE39	PATIL AJINKYA DAYANAND MANISHA	ELECTRICAL ENGINEERING
852	BE40	PATIL ARPITA SHRIDHAR	ELECTRICAL ENGINEERING
853	BE41	PATIL NIKET ANANT	ELECTRICAL ENGINEERING
854	BE42	PATIL PRADNYA PANDURANG	ELECTRICAL ENGINEERING
855	BE43	PATIL PRAJYOTI LAXMAN	ELECTRICAL ENGINEERING
856	BE44	PATIL PRITESH PRABHAKAR	ELECTRICAL ENGINEERING
857	BE45	PATIL RUSHIKESH BABAN	ELECTRICAL ENGINEERING
858	BE46	PATIL SUMIT SANJAY NEHA	ELECTRICAL ENGINEERING
859	BE47	PATIL TEJAS CHANDRAKANT	ELECTRICAL ENGINEERING
860	BE48	PAWAR MANGESH ANKUSH	ELECTRICAL ENGINEERING
861	BE49	PINGALE JAY KASHINATH	ELECTRICAL ENGINEERING
862	BE50	PINGALE PRIYANKA KRUSHNA DEEPA	ELECTRICAL ENGINEERING
863	BE51	RAJHANS ANKIT RAVINDRA	ELECTRICAL ENGINEERING
864	BE52	RAUT SAIRAJ SUNIL	ELECTRICAL ENGINEERING
865	BE53	SAKPAL ONKAR PRADEEP	ELECTRICAL ENGINEERING
866	BE54	SATRE HARSHADA VIJAY	ELECTRICAL ENGINEERING
867	BE55	SAWANT AMEY ANAND	ELECTRICAL ENGINEERING
868	BE56	SHELAR SHUBHAM SANTOSH MANGAL	ELECTRICAL ENGINEERING
869	BE57	SHINDE MILIND KISHOR ALKA	ELECTRICAL ENGINEERING
870	BE58	SHINGRUT ROSHANI SANJAY	ELECTRICAL ENGINEERING
871	BE59	SHIRKE SHUBHAM SUDESH	ELECTRICAL ENGINEERING
872	BE60	SINGH YASH SHRAVAN	ELECTRICAL ENGINEERING
873	BE61	THOMBARE PRIYANKA	ELECTRICAL ENGINEERING
874	BE62	TIWARI SAURABH RAGHAVENDRA	ELECTRICAL ENGINEERING
875	BE63	TUPE OMKAR ASHOK	ELECTRICAL ENGINEERING
876	BE64	UBHARE ROHII RAMDAS	ELECTRICAL ENGINEERING
877	BE65	YADAV AWDHESH KUMAR	ELECTRICAL ENGINEERING
878	SE1	ABDUL FARHAN ABDUL KARIM SAMAN	ELECTRONICS AND TELECOMMUNICAT
879	SE2	BAGAYATKAR YASH ABHAS	ELECTRONICS AND TELECOMMUNICAT
880	SE3	BHOIR ISHIKA RAVINDRA	ELECTRONICS AND TELECOMMUNICAT
881	SE4	DABIR SAKSHI PADMAKAR	ELECTRONICS AND TELECOMMUNICAT



TRUE COPY

B.K.P.
Principal
Vishwaniketan's (i MEET)

882	SE5	DESHPANDE APURVA VIDYADHAR	ELECTRONICS AND TELECOMMUNICAT
883	SE6	DESHPANDE PRATHAMA VIDYADHAR	ELECTRONICS AND TELECOMMUNICAT
884	SE7	DHANAWADE PRATHAMESH JITENDRA	ELECTRONICS AND TELECOMMUNICAT
885	SE8	GHARAT MRUNAL SANDEEP	ELECTRONICS AND TELECOMMUNICAT
886	SE9	GODSE VEDANT SHRIKANT	ELECTRONICS AND TELECOMMUNICAT
887	SE10	JOSHI NIKHIL JANARDAN	ELECTRONICS AND TELECOMMUNICAT
888	SE11	JOSHI SUJALDEV SUNIL	ELECTRONICS AND TELECOMMUNICAT
889	SE12	KAZI ZAYAN SHABBIR SHAINAZ	ELECTRONICS AND TELECOMMUNICAT
890	SE13	KOKANE RUSHIKESH BHANUDAS	ELECTRONICS AND TELECOMMUNICAT
891	SE14	KOLI ASHISH MANOJ	ELECTRONICS AND TELECOMMUNICAT
892	SE15	KUSHWAHA AKHILESH GOPAL	ELECTRONICS AND TELECOMMUNICAT
893	SE16	MANE MRUGANAYANI VINOD	ELECTRONICS AND TELECOMMUNICAT
894	SE17	MOHITE KOMALL MANDAR	ELECTRONICS AND TELECOMMUNICAT
895	SE18	PANDE RAVIKUMAR DAYANAND	ELECTRONICS AND TELECOMMUNICAT
896	SE19	PANDITPAUTRA VRIKSH KALPESH	ELECTRONICS AND TELECOMMUNICAT
897	SE20	PATIL AKANKSHA HEMANT	ELECTRONICS AND TELECOMMUNICAT
898	SE21	PATIL OM RAJENDRA	ELECTRONICS AND TELECOMMUNICAT
899	SE22	PATIL VISHAL RAJENDRA	ELECTRONICS AND TELECOMMUNICAT
900	SE23	PHADTARE ABHISHEK HANUMANT	ELECTRONICS AND TELECOMMUNICAT
901	SE24	RANE MANISH DATTARAM	ELECTRONICS AND TELECOMMUNICAT
902	SE25	SHAJOL V.SHAJI JOLLYMMA	ELECTRONICS AND TELECOMMUNICAT
903	SE26	SHARMA RICHA GIANESHWAR	ELECTRONICS AND TELECOMMUNICAT
904	SE27	SHINDE ASHWINI DEEPAK	ELECTRONICS AND TELECOMMUNICAT
905	SE28	SHINDE VISHWAJEET DATTATRAY	ELECTRONICS AND TELECOMMUNICAT
906	SE29	SONAWALE SAURABH SUBHASH	ELECTRONICS AND TELECOMMUNICAT
907	SE30	VERMA SHASHANK RAMESHANKAR	ELECTRONICS AND TELECOMMUNICAT
908	SE31	WADKAR VINAY ANIL	ELECTRONICS AND TELECOMMUNICAT
909	SE32	WAGH RUSHABH SANJAY	ELECTRONICS AND TELECOMMUNICAT
910	TE 01	AHIRE ASHISH NITIN	ELECTRONICS AND TELECOMMUNICAT
911	TE 02	BHALERAO SHUBHAM SANJAY	ELECTRONICS AND TELECOMMUNICAT
912	TE 03	BHOPI MAYURESH MOHAN	ELECTRONICS AND TELECOMMUNICAT
913	TE 04	BHOSALE DHANASHREE MANOHAR	ELECTRONICS AND TELECOMMUNICAT
914	TE 05	BHOSALE KIRAN SANJEEV	ELECTRONICS AND TELECOMMUNICAT
915	TE 06	DASWADKAR MILIND JANARDAN	ELECTRONICS AND TELECOMMUNICAT
916	TE 07	DESHMUKH RUTUJA KISHOR	ELECTRONICS AND TELECOMMUNICAT
917	TE 08	DESHMUKH SHWETA SUNIL	ELECTRONICS AND TELECOMMUNICAT
918	TE 09	KUMBHAR KUNAL SHASHIK	ELECTRONICS AND TELECOMMUNICAT

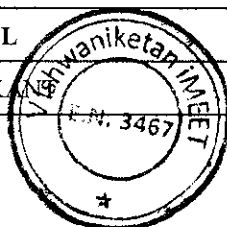

TRUE COPY
 Principal
 Vishwaniketan's (I MEET)

919	TE 10	LOTE MANSI VINAYAK	ELECTRONICS AND TELECOMMUNICAT
920	TE 11	DAKSH MAAN KUSHALPAI	ELECTRONICS AND TELECOMMUNICAT
921	TE 12	MANE PRATIKSHA AJIT	ELECTRONICS AND TELECOMMUNICAT
922	TE 13	MILATRE RUPALI SHAILESH	ELECTRONICS AND TELECOMMUNICAT
923	TE 14	MOKAL SWAGAT ANIL	ELECTRONICS AND TELECOMMUNICAT
924	TE 15	MORE NIHAR SANDEEP	ELECTRONICS AND TELECOMMUNICAT
925	TE 16	MORE PRATIKSHA DILIP	ELECTRONICS AND TELECOMMUNICAT
926	TE 17	NEMADE GAURAV SANTOSH	ELECTRONICS AND TELECOMMUNICAT
927	TE 18	PATIL JAYDIP PRAKASH	ELECTRONICS AND TELECOMMUNICAT
928	TE 19	PATIL NIKITA BABASAHEB	ELECTRONICS AND TELECOMMUNICAT
929	TE 20	PATIL VINEET VASANT	ELECTRONICS AND TELECOMMUNICAT
930	TE 21	PAWAR SANKET BAPU	ELECTRONICS AND TELECOMMUNICAT
931	TE 22	PINGALE KEDAR SUNIL	ELECTRONICS AND TELECOMMUNICAT
932	TE 23	SHAHANE SAKSHI ATUL	ELECTRONICS AND TELECOMMUNICAT
933	TE 24	SONAWALE AJINKYA SUBHASH	ELECTRONICS AND TELECOMMUNICAT
934	TE 25	SUTAR SHARVARI KISHOR	ELECTRONICS AND TELECOMMUNICAT
935	TE 26	THAKARE TEJASVI GANESH	ELECTRONICS AND TELECOMMUNICAT
936	TE 27	THOMBARE SHRADDHA GAJENDRA	ELECTRONICS AND TELECOMMUNICAT
937	BE 01	AWASKAR SAYALI BHARAT	ELECTRONICS AND TELECOMMUNICAT
938	BE 02	BAMBORI PRATIKSHA CHETANKUMAR	ELECTRONICS AND TELECOMMUNICAT
939	BE 03	BANGAR SHUBHAM VIVEKANAND	ELECTRONICS AND TELECOMMUNICAT
940	BE 04	BHOSALE ANIKET GANPAT	ELECTRONICS AND TELECOMMUNICAT
941	BE 05	BODEKAR ARATI BALU	ELECTRONICS AND TELECOMMUNICAT
942	BE 06	DESAI HRUSHIKESH RAJENDRA	ELECTRONICS AND TELECOMMUNICAT
943	BE 07	DESAI PRIYANKA ARUN	ELECTRONICS AND TELECOMMUNICAT
944	BE 08	DHIGARE AKSHAY ANANDA	ELECTRONICS AND TELECOMMUNICAT
945	BE 09	GHARAT AJIT ARUN	ELECTRONICS AND TELECOMMUNICAT
946	BE 10	GIRI SAKSHI GAJANAN	ELECTRONICS AND TELECOMMUNICAT
947	BE 11	GONDHALI SWAPNIL DHANAJI	ELECTRONICS AND TELECOMMUNICAT
948	BE 12	HALDAR SOURADEEP	ELECTRONICS AND TELECOMMUNICAT
949	BE 13	ITHAPE PRIYANKA RAJARAM	ELECTRONICS AND TELECOMMUNICAT
950	BE 14	JAMBHALE PRERANA DINKAR	ELECTRONICS AND TELECOMMUNICAT
951	BE 15	KHARADE SANKET SUNIL	ELECTRONICS AND TELECOMMUNICAT
952	BE 16	KHOT AKSHAY VISHNU	ELECTRONICS AND TELECOMMUNICAT
953	BE 17	MAITY INDRAJIT NARENDRA	ELECTRONICS AND TELECOMMUNICAT
954	BE 18	MALI PRANJALI MAYKUMAR	ELECTRONICS AND TELECOMMUNICAT
955	BE 19	MANDAVKAR SOURABH SANJAY	ELECTRONICS AND TELECOMMUNICAT

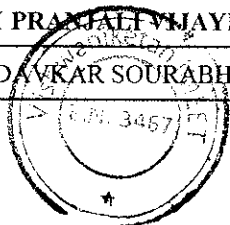

TRUE COPY

[Signature]
Principal
Vishwakarma's (I.I.E.E.T)

956	BE 20	MHATRE PRANALI CHANDRAKANT	ELECTRONICS AND TELECOMMUNICAT
957	BE 21	MHATRE SUVIDHA SAROJKUMAR	ELECTRONICS AND TELECOMMUNICAT
958	BE 22	MHATRE VIKRANTI MANGESH	ELECTRONICS AND TELECOMMUNICAT
959	BE 23	MISHRA KESHAV HARISH	ELECTRONICS AND TELECOMMUNICAT
960	BE 24	PATIL NIDHI VINIT	ELECTRONICS AND TELECOMMUNICAT
961	BE 25	PATIL SHARAYU SHANKAR	ELECTRONICS AND TELECOMMUNICAT
962	BE 26	SALVEKAR PRATIKSHA PRASHANT	ELECTRONICS AND TELECOMMUNICAT
963	BE 27	SALVI PRATHAMESH BHASKAR	ELECTRONICS AND TELECOMMUNICAT
964	BE 28	SHELKE TITIKSHA CHANGDEV	ELECTRONICS AND TELECOMMUNICAT
965	BE 29	SHILIMKAR PRATIKSHA MANOHAR	ELECTRONICS AND TELECOMMUNICAT
966	BE 30	SHINDE MINAL MAHESH	ELECTRONICS AND TELECOMMUNICAT
967	BE 31	SHIVALE MINAL SHIVAJI	ELECTRONICS AND TELECOMMUNICAT
968	BE 32	TALEKAR MUKESH DEVIDAS	ELECTRONICS AND TELECOMMUNICAT
969	BE 33	UGALE PRATIKSHA ANIL	ELECTRONICS AND TELECOMMUNICAT
970	BE 34	VALMIK ERESHWARI MALLESH	ELECTRONICS AND TELECOMMUNICAT
971	BE 35	VASHISHTH NAMAN DINESH	ELECTRONICS AND TELECOMMUNICAT
972	BE 36	WALGUDE APEKSHA VIKAS	ELECTRONICS AND TELECOMMUNICAT
973	BE 37	WANI SIMRAN KRISHNANATH	ELECTRONICS AND TELECOMMUNICAT
974	BE 38	YADAV GEETA BALKISHAN	ELECTRONICS AND TELECOMMUNICAT
975	SEA01	AJILWAD RUSHIKESH PRAKASH LATA	MECHANICAL ENGINEERING
976	SEA02	ASHTPUTRE SARTHAK SANEDDP SEEMA	MECHANICAL ENGINEERING
977	SEA03	BABRE TUSHAR GANESH SANGEETA	MECHANICAL ENGINEERING
978	SEA04	BADGUJAR NACHIKET YUVRAJ SANGEETA	MECHANICAL ENGINEERING
979	SEA05	BARDAY MOHAMMAD TABISH MOHAMMAD IS	MECHANICAL ENGINEERING
980	SEA06	BHAT RAMKRISHNA KISHORE DEEPA	MECHANICAL ENGINEERING
981	SEA07	BHOIR MUKESH DASHARATH NARMADA	MECHANICAL ENGINEERING
982	SEA08	BISWAL ASHIRWAD RADHAMOHAN MANASIR	MECHANICAL ENGINEERING
983	SEA09	BISWAS JAYKUMAR KARTICK ALPANARANI	MECHANICAL ENGINEERING
984	SEA10	CHAVAN OMKAR TATOO TANUJA	MECHANICAL ENGINEERING
985	SEA11	CHOGALE PRATHAMESH PANDURANG SANGIT	MECHANICAL ENGINEERING
986	SEA12	CHOGALE VINIT SUDAM	MECHANICAL ENGINEERING
987	SEA13	CHORAGHE MANOJ MARUTI AASHA	MECHANICAL ENGINEERING
988	SEA14	CHOURASIYA VISHAL PRIYAVRAT PUSHPA	MECHANICAL ENGINEERING
989	SEA15	DALVI YADNESH DNYANESHWAR DEEPTI	MECHANICAL ENGINEERING
990	SEA17	GAIKWAD SAHIL DINESH RAJASHREE	MECHANICAL ENGINEERING
991	SEA18	GHARAT RAJ JANARDAN SUNITA	MECHANICAL ENGINEERING
992	SEA19	GHOSALKAR JIGNESH ANIL SUVARNA	MECHANICAL ENGINEERING



TRUE COPY

[Handwritten Signature]

Principal

Vishwaniketan's (MEET)

993	SEA20	GODBOLE MANAS YOGESH NISHA	MECHANICAL ENGINEERING
994	SEA21	GUPTA ASHU SANJAY	MECHANICAL ENGINEERING
995	SEA22	JADHAV DIPESH DILIP SUREKHA	MECHANICAL ENGINEERING
996	SEA23	JADHAV PRATHAMESH SANTOSH KALPANA	MECHANICAL ENGINEERING
997	SEA24	JAGTAP PUNIT JAYVANT KADMBARI	MECHANICAL ENGINEERING
998	SEA25	JOSHI SUYOG NITIN SANGITA	MECHANICAL ENGINEERING
999	SEA26	KARJIKAR ARFAZ MOHAMMAD HANIF NASEEM	MECHANICAL ENGINEERING
1000	SEA27	KATE JAY VIJAY VISHAKHA	MECHANICAL ENGINEERING
1001	SEA28	KHAIR ROSHAN RAJENDRA SHARDA	MECHANICAL ENGINEERING
1002	SEA29	KHAN ADNAN SOFIYAN AKHTARI	MECHANICAL ENGINEERING
1003	SEA30	KHEDEKAR TEJAS SACHIN NISHA	MECHANICAL ENGINEERING
1004	SEA31	KOLI SHIVAM RAJENDRA SUNITA	MECHANICAL ENGINEERING
1005	SEA32	KUMBHAR SHIVKUMAR BHARAT SHANKRAM	MECHANICAL ENGINEERING
1006	SEA33	KUSHWAHA ABHISHEK RAMBADAN GYANTY	MECHANICAL ENGINEERING
1007	SEA34	LOTE MAHESH UMESH INDU	MECHANICAL ENGINEERING
1008	SEA35	LOTE MAYUR NANDKUMAR BABY	MECHANICAL ENGINEERING
1009	SEA36	MANDHARE PRANAY DATTATRAY CHHAYA	MECHANICAL ENGINEERING
1010	SEA37	MHASE ROSHAN GANESH SUREKHA	MECHANICAL ENGINEERING
1011	SEA38	MISHRA ROSHAN SANJEEV BABLI	MECHANICAL ENGINEERING
1012	SEA39	MUSALE SANKET SUNIL SEEMA	MECHANICAL ENGINEERING
1013	SEA40	PANDEY MAYANK JAYPRAKASH SANJU	MECHANICAL ENGINEERING
1014	SEA41	PATHAK SHREYAS SHRINIVAS ANAGHA	MECHANICAL ENGINEERING
1015	SEA42	PATIL ABHIYASH MANOJ CHANDRAKALA	MECHANICAL ENGINEERING
1016	SEA43	PATIL ASHISH PRAVIN PRANITA	MECHANICAL ENGINEERING
1017	SEA44	PATIL HARSH TUKARAM SANJAYA	MECHANICAL ENGINEERING
1018	SEA45	PATIL NISHANT BALKRISHNA SARITA	MECHANICAL ENGINEERING
1019	SEA46	PATIL ROHIT CHANDRAKANT ALAKA	MECHANICAL ENGINEERING
1020	SEA47	PATIL SAHIL VIVEK SWATI	MECHANICAL ENGINEERING
1021	SEA48	PAWAR SAURABH SUNIL SUJATA	MECHANICAL ENGINEERING
1022	SEA49	PINGALE PRITESH SHANMUKH SIMA	MECHANICAL ENGINEERING
1023	SEA50	POLEKAR MEGHRAJ DNYANESHWAR SAVITA	MECHANICAL ENGINEERING
1024	SEA51	RAUT SOHAM AMOL SAVITA	MECHANICAL ENGINEERING
1025	SEA52	SACHAN SARANSH YOGENDRA RENU	MECHANICAL ENGINEERING
1026	SEA53	SADHU GHANSHYAM VITHOBA VANDANA	MECHANICAL ENGINEERING
1027	SEA54	SALUNKE ASHISH ASHOK ASHWINI	MECHANICAL ENGINEERING
1028	SEA55	SHAH HARDIK PRADEEP SADHANA	MECHANICAL ENGINEERING
1029	SEA56	SHARMA JEETENDRA ROHITASH MEMLATA	MECHANICAL ENGINEERING



TRUE COPY

[Handwritten Signature]

Vishwaniketan's (I.M.E.T.)

1030	SEA57	SHARMA MANISH SUNIL SANGEETA	MECHANICAL ENGINEERING
1031	SEA58	SHARMA ROSHAN BARVN NEELAM	MECHANICAL ENGINEERING
1032	SEA59	SHINDE AKASH BHIMSEN JAYASHREE	MECHANICAL ENGINEERING
1033	SEA60	SHINGRUT SANMESH SANJAY SUPRIYA	MECHANICAL ENGINEERING
1034	SEA61	SINGH DEEPAK DINESH	MECHANICAL ENGINEERING
1035	SEA62	SINGH HEMANT AKHILESH BEENA	MECHANICAL ENGINEERING
1036	SEA63	SINGH NIRAJ DHARMENDRA POONAM	MECHANICAL ENGINEERING
1037	SEA64	SINGH SUMIT KUMAR SUNIL KUMAR MANJU	MECHANICAL ENGINEERING
1038	SEA65	SONAWANE SWAPNIL SAVKAR NUTAN	MECHANICAL ENGINEERING
1039	SEA66	SURVE SARVESH RAMESH RESHMA	MECHANICAL ENGINEERING
1040	SEA67	SURYAVANSHI PRATIK DINKAR SEEMA	MECHANICAL ENGINEERING
1041	SEA68	TARAVADE VEDANT MOHAN VAISHALI	MECHANICAL ENGINEERING
1042	SEA69	THOMBARE SHUBHAM PRADEEP NEETA	MECHANICAL ENGINEERING
1043	SEA70	THOSAR SHUBHAM RAVIKANT KALPANA	MECHANICAL ENGINEERING
1044	SEA71	VARANSHE SHUBHAM RAJENDRA USHA	MECHANICAL ENGINEERING
1045	SEA73	VISHWAKARMA ANUJ LALJI REETA DEVI	MECHANICAL ENGINEERING
1046	SEB01	BHAGAT MOHIT SANTOSH SAMIKSHA	MECHANICAL ENGINEERING
1047	SEB02	BHAVKE SHUBHAM SHANKAR	MECHANICAL ENGINEERING
1048	SEB03	BHAVSAR HRUSHIKESH MILIND MANISHA	MECHANICAL ENGINEERING
1049	SEB04	BHOSALE KOMAL ANIL GEETA	MECHANICAL ENGINEERING
1050	SEB05	BORKAR ANUJ HANUMANT REKHA	MECHANICAL ENGINEERING
1051	SEB06	CHOGLE HANZALA ARIF SAMEENA	MECHANICAL ENGINEERING
1052	SEB07	DIVEKAR PRAMOD TUKARAM MEENA	MECHANICAL ENGINEERING
1053	SEB08	DOKHALE JIVAN DHARMA ROHINI	MECHANICAL ENGINEERING
1054	SEB09	DUKHANDE YASH MILIND SHUBHANGI	MECHANICAL ENGINEERING
1055	SEB10	GAIKAWAD PRATHAMESH BAPURAO VANDAN	MECHANICAL ENGINEERING
1056	SEB11	GAIKWAD SACHIN MARUTI HAUSA	MECHANICAL ENGINEERING
1057	SEB12	GHOOGARE TEJAS ANIL SUJATA	MECHANICAL ENGINEERING
1058	SEB13	KAMBLE NIKHIL VIKAS SAVITA	MECHANICAL ENGINEERING
1059	SEB14	KARADE MANOJ NANA SAVITA	MECHANICAL ENGINEERING
1060	SEB15	KATKE SHIVAM ASHOK ANUSAYA	MECHANICAL ENGINEERING
1061	SEB16	KHARCHE KETAN LAXMAN LAXMAN APARNA	MECHANICAL ENGINEERING
1062	SEB17	KHULAM SUSHILKUMAR JAYAVANT SUPRIYA	MECHANICAL ENGINEERING
1063	SEB18	MAGAR ABHISHEK NANDKUMAR HARSHDA	MECHANICAL ENGINEERING
1064	SEB19	MAHADIK SWAPNIL SHANTARAM SHITAL	MECHANICAL ENGINEERING
1065	SEB20	MANVE SUNIL BABAN SUVARNA	MECHANICAL ENGINEERING
1066	SEB21	MHATRE SUYOG KISHOR SUREKHA	MECHANICAL ENGINEERING

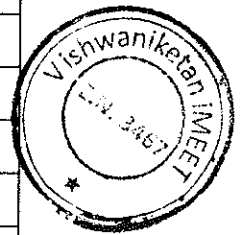

TRUE COPY

[Handwritten Signature]

1067	SEB22	MHATRE VEDANT RAJENDRA SANGITA	MECHANICAL ENGINEERING
1068	SEB23	MODAK GAURAV CHANDRAKANT CHAITALI	MECHANICAL ENGINEERING
1069	SEB24	MORE KARAN HARISHCHANDRA MANDA	MECHANICAL ENGINEERING
1070	SEB25	NEMAN SIDDHARTH HEMU HEMANTI	MECHANICAL ENGINEERING
1071	SEB26	NIMASE VIGHNESH BHAGWAN SANTOSHI	MECHANICAL ENGINEERING
1072	SEB27	PANCHAL KUNAL PRADEEP APARNA	MECHANICAL ENGINEERING
1073	SEB28	PAPAL KARAN MAHADEO SHOBHA	MECHANICAL ENGINEERING
1074	SEB29	PARTHE DINESH SANTOSH MEENA	MECHANICAL ENGINEERING
1075	SEB30	PATIL AKASH CHANDRAKANT SHUBHANGI	MECHANICAL ENGINEERING
1076	SEB31	PATIL AMIT TULSHINATH ALKA	MECHANICAL ENGINEERING
1077	SEB32	PATIL ASHISH SAMADHAN KUNDA	MECHANICAL ENGINEERING
1078	SEB33	PATIL PRANAY GANESH UJJAWALA	MECHANICAL ENGINEERING
1079	SEB34	PATIL RAJ RAMESH ASHA	MECHANICAL ENGINEERING
1080	SEB35	PATIL SUBODH SHIVAJI	MECHANICAL ENGINEERING
1081	SEB36	PATIL SURAJ SHASHIKANT SHUBHANGI	MECHANICAL ENGINEERING
1082	SEB37	PATIL TEJASVI SHARAD ASHA	MECHANICAL ENGINEERING
1083	SEB38	PATOLE SACHIN PRAKASH SUREKHA	MECHANICAL ENGINEERING
1084	SEB39	PAWAR HRISHIKESH SANDIPAN NEETA	MECHANICAL ENGINEERING
1085	SEB40	PAWAR VED GAJANAN NAYANA	MECHANICAL ENGINEERING
1086	SEB41	PINGALE MANISH SHYAM NEERA	MECHANICAL ENGINEERING
1087	SEB42	PRABHU TUSHAR RAVINDRA SHOBHANA	MECHANICAL ENGINEERING
1088	SEB43	RATAMBE TEJAS MANOHAR MADHAVI	MECHANICAL ENGINEERING
1089	SEB44	RAVALE KETAN GOPAL POONAM	MECHANICAL ENGINEERING
1090	SEB45	RUBDE SHAILESH ANIL SHUBHANGI	MECHANICAL ENGINEERING
1091	SEB46	RUPANWAR PRATIK HANUMANT BHAGYASHRI	MECHANICAL ENGINEERING
1092	SEB47	SALEKAR RAJ MANOHAR SUSHMA	MECHANICAL ENGINEERING
1093	SEB48	SAWANT DEVARSH VIVEK SMITA	MECHANICAL ENGINEERING
1094	SEB49	SHAIKH MOHAMMED FARHAN FAIYAZ AHMAD	MECHANICAL ENGINEERING
1095	SEB50	SHINDE AKASH DIGAMBAR SANDHYA	MECHANICAL ENGINEERING
1096	SEB51	SHINDE VIPUL SHRIMANT RUPALI	MECHANICAL ENGINEERING
1097	SEB52	SOMANE OMKAR PRADEEP PRAMILA	MECHANICAL ENGINEERING
1098	SEB53	SONAWANE JAYESH NARESH JYOTI	MECHANICAL ENGINEERING
1099	SEB54	TAMBE PRATIK PRABHAKAR PRANITA	MECHANICAL ENGINEERING
1100	SEB55	TELAGE DHIRAJ GIRISH MINAKSHI	MECHANICAL ENGINEERING
1101	SEB56	THAKUR DHIRANJALI PRAKASH MAHANADA	MECHANICAL ENGINEERING
1102	SEB57	THAKUR SWAPNIL SANTOSH SAPNA	MECHANICAL ENGINEERING
1103	SEB58	THALKAR RUTIK PARSHURAM SUSHMA	MECHANICAL ENGINEERING

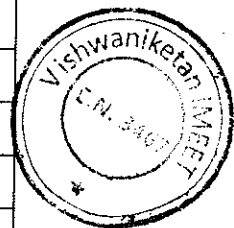

TRUE COPY

[Signature]

Principal

Vishwaniketan's (I MEE)

1104	SEB59	VIHAL MANDEEPSINGH GURMEETSINGH SUKUMAR	MECHANICAL ENGINEERING
1105	SEB60	WAGHMARE DNYANESHVAR DATTA GIRAJA	MECHANICAL ENGINEERING
1106	SEB61	WAVEKAR SIDDHANT SURESH ALAKA	MECHANICAL ENGINEERING
1107	SEB62	YERUNKAR SAHIL VIJAY VINATI	MECHANICAL ENGINEERING
1108	SEB63	DESHMUKH SHUBHAM RAJENDRA URMILA	MECHANICAL ENGINEERING
1109	SEB64	VIDWANS MANAS CHINTAMANI RAJSHREE	MECHANICAL ENGINEERING
1110	TEA01	ANDHALE ANIKET SAMPAT SARALA	MECHANICAL ENGINEERING
1111	TEA02	ARKE SAGAR BHAUSAHEB REKHA	MECHANICAL ENGINEERING
1112	TEA03	ATKARI TEJAS SANJAY ARCHANA	MECHANICAL ENGINEERING
1113	TEA04	BAGUL HARSHAL EKNATH SEEMA	MECHANICAL ENGINEERING
1114	TEA05	BANGAR VIKAS ARJUN SAUBAI	MECHANICAL ENGINEERING
1115	TEA06	BARUA ABHISHEK RANJIT JAYITA	MECHANICAL ENGINEERING
1116	TEA07	BARVE AKASH SATYVAN ASHWINI	MECHANICAL ENGINEERING
1117	TEA08	BHAGAT AKSHAY ANANDKUMAR PRAMILA	MECHANICAL ENGINEERING
1118	TEA09	BHAWKE OMKAR BAJARANG SHUBHANGI	MECHANICAL ENGINEERING
1119	TEA10	BHAYTANDEL ANIKET CHANDRAKANT KAVITA	MECHANICAL ENGINEERING
1120	TEA11	BHOIR ROHAN HEMANT PRATIBHA	MECHANICAL ENGINEERING
1121	TEA12	BHOSALE OMKAR SHANKAR SANDHYA	MECHANICAL ENGINEERING
1122	TEA13	BHUSARI APURV VISHNU ALKA	MECHANICAL ENGINEERING
1123	TEA14	CHANDEL SATEJSINGH MAHENDRASINGH	MECHANICAL ENGINEERING
1124	TEA15	CHANDORKAR SOHAM ATUL SUCHITRA	MECHANICAL ENGINEERING
1125	TEA16	CHAUDHARY HIMANSHU PRALHAD SHEETAL	MECHANICAL ENGINEERING
1126	TEA17	CHAVAN VISHWAJIT SATISH VRUSHALI	MECHANICAL ENGINEERING
1127	TEA18	CHOUDHARY SURAJ KEDAR PRASAD SUDHAKAR	MECHANICAL ENGINEERING
1128	TEA19	DALVI KUNAL RAVINDRA VAISHALI	MECHANICAL ENGINEERING
1129	TEA20	DALVI MAYURESH SUNIL MADHURI	MECHANICAL ENGINEERING
1130	TEA21	DESHMUKH NIKHIL UDAY	MECHANICAL ENGINEERING
1131	TEA22	DESHMUKH SAHIL DINESH DIPIKA	MECHANICAL ENGINEERING
1132	TEA23	DESHMUKH SANKET SURESH NIRMALA	MECHANICAL ENGINEERING
1133	TEA24	DHARANE DIPESH ASHOK ASHWINI	MECHANICAL ENGINEERING
1134	TEA25	DHUMAL AKASH ARVIND SAVITA	MECHANICAL ENGINEERING
1135	TEA26	DUDHBHATE SURAJ KHANDU KAMAL	MECHANICAL ENGINEERING
1136	TEA27	FAKKE AKASH RAJENDRA RUCHITRA	MECHANICAL ENGINEERING
1137	TEA28	GAIKWAD JAY PRAFULL REKHA	MECHANICAL ENGINEERING
1138	TEA29	GAIKWAD MRUNAL NARENDRA MALATI	MECHANICAL ENGINEERING
1139	TEA30	GAJRE ABHISHEK AMRUT SUNITA	MECHANICAL ENGINEERING
1140	TEA31	GATARE SHARDUL SHEKHAR MINAL	MECHANICAL ENGINEERING

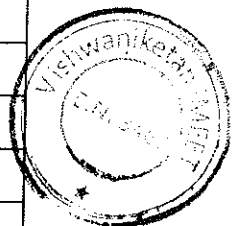

TRUE COPY

[Handwritten Signature]

Principal
Vishwaniketan's (VMEET)

1141	TEA32	GAVADE OMKAR SANTOSH RUPALI	MECHANICAL ENGINEERING
1142	TEA33	GHADAGE UTKARSH MADHUKAR SUSHAMA	MECHANICAL ENGINEERING
1143	TEA34	GHARAT AARTI VISHWANATH ARCHANA	MECHANICAL ENGINEERING
1144	TEA35	GHARAT ABHIJIT RAMCHANDRA	MECHANICAL ENGINEERING
1145	TEA36	GHARAT DIPTESH CHANDRAKANT VAISHALI	MECHANICAL ENGINEERING
1146	TEA37	GHARAT PUSHPAK RAJESH SUNITA	MECHANICAL ENGINEERING
1147	TEA38	GHARAT SARVESH SHIVDAS JAYASHREE	MECHANICAL ENGINEERING
1148	TEA39	GHOLE DAKSHIT SURESH SUCHITA	MECHANICAL ENGINEERING
1149	TEA40	GHOSALKAR PARESH PRAKASH PRATIKSHA	MECHANICAL ENGINEERING
1150	TEA41	HEGISTE BHUSHAN SHRIKANT SHRADDHA	MECHANICAL ENGINEERING
1151	TEA42	INGALE ONKAR LAXMAN	MECHANICAL ENGINEERING
1152	TEA43	JADHAV GAURAV CHHOTULAL MANJUSHA	MECHANICAL ENGINEERING
1153	TEA44	JADHAV ROHIT BAPUSO	MECHANICAL ENGINEERING
1154	TEA45	JAIN SHUBHAM PARASMAL	MECHANICAL ENGINEERING
1155	TEA46	JOSHI RUTIK PRABHAKAR PRATIKSHA	MECHANICAL ENGINEERING
1156	TEA47	KADU YASH JITENDRA POOJA	MECHANICAL ENGINEERING
1157	TEA48	KAMBALE SIDDHANT SANJAY SUREKHA	MECHANICAL ENGINEERING
1158	TEA49	KAMBLE ANIKET BALU BHARATI	MECHANICAL ENGINEERING
1159	TEA50	KAMBLE SUMEDH BALIRAM KALPANA	MECHANICAL ENGINEERING
1160	TEA51	KANU RESHMA NANDKISHOR	MECHANICAL ENGINEERING
1161	TEA52	KARKARE ANKIT RAMESH SMITA	MECHANICAL ENGINEERING
1162	TEA53	KATE MOHAN DNYANDEV PUSHPA	MECHANICAL ENGINEERING
1163	TEA54	KATKE KUNAL NANDKUMAR KARUNA	MECHANICAL ENGINEERING
1164	TEA55	KHANDALE RAVINDRA BIRAPPA	MECHANICAL ENGINEERING
1165	TEA56	KHANDEKAR TUSHAR RAJARAM SAMPADA	MECHANICAL ENGINEERING
1166	TEA57	KHEDEKAR SHUBHAM RAOSAHEB ANITA	MECHANICAL ENGINEERING
1167	TEA58	KOKANE OMKAR SOMESHWAR JYOTI	MECHANICAL ENGINEERING
1168	TEA59	KULKARNI SHREERANG PRAMOD SANJEEVAN	MECHANICAL ENGINEERING
1169	TEA60	KURMI VAIBHAV SHAMBHU USHA	MECHANICAL ENGINEERING
1170	TEA61	LAGDHIR MAYUR RAMJI HIRIBEN	MECHANICAL ENGINEERING
1171	TEA62	LANGI SAMIKSHA YOGESH UJWALA	MECHANICAL ENGINEERING
1172	TEA63	LENDAVE SUYASH SIDDHESHWAR SANGEETA	MECHANICAL ENGINEERING
1173	TEA64	MADHAVI SARVESH SANTOSH HEMLATA	MECHANICAL ENGINEERING
1174	TEA65	MALI NIRAJ JIJABRAO PARUL	MECHANICAL ENGINEERING
1175	TEA66	MALI SAHIL SHARAD RANJANA	MECHANICAL ENGINEERING
1176	TEA67	MANE NIKHIL SURESH MANISHA	MECHANICAL ENGINEERING
1177	TEA68	MHATRE KUNAL BALIRAM ROHINI	MECHANICAL ENGINEERING

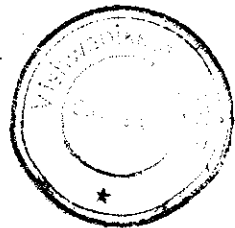

TRUE COPY

[Handwritten Signature]

Principal
Vishwaniketan's (I) MEET

1178	TEA69	MHATRE KUNAL SHASHIKANT	MECHANICAL ENGINEERING
1179	TEA70	MHATRE MRUNAL KRISHNA RAJESHRI	MECHANICAL ENGINEERING
1180	TEA71	MHATRE NITESH MUKUND GEETA	MECHANICAL ENGINEERING
1181	TEA72	MORE SONAL HARIBHAU NIRMALA	MECHANICAL ENGINEERING
1182	TEA73	SORATE AKSHATA ASHOK MANISHA	MECHANICAL ENGINEERING
1183	TEB01	MHATRE PRATIK JANARDAN POONAM	MECHANICAL ENGINEERING
1184	TEB02	MOKAL AMIT VILAS SUJATA	MECHANICAL ENGINEERING
1185	TEB03	MOKAL NANDAN ANIL SUNANDA	MECHANICAL ENGINEERING
1186	TEB04	MOKAL SAHIL KAMALAKAR RANJANA	MECHANICAL ENGINEERING
1187	TEB05	MORE AJINKYA AMOL SONALI	MECHANICAL ENGINEERING
1188	TEB06	NADKAR SHUBHAM RAMESH ROSHNI	MECHANICAL ENGINEERING
1189	TEB07	NAIK SAHIL UMESH PRIYANKA	MECHANICAL ENGINEERING
1190	TEB08	NANDE ATHARVA MANOJ	MECHANICAL ENGINEERING
1191	TEB09	NANGARE RAHUL JITENDRA LATA	MECHANICAL ENGINEERING
1192	TEB10	NANGARE SHIVAM RAMDAS PRANITA	MECHANICAL ENGINEERING
1193	TEB11	NARVEKAR SHREEMAY SANJAY SUDHA	MECHANICAL ENGINEERING
1194	TEB12	PABLE SUKHJEETSINGH AVTARSINGH JAGDIS	MECHANICAL ENGINEERING
1195	TEB13	PANDEY PIYUSH RAMSAJIVAN SUMAN	MECHANICAL ENGINEERING
1196	TEB14	PANDEY SHASHANK ARUN KUMAR	MECHANICAL ENGINEERING
1197	TEB15	PATIL ADITYA KANTILAL ANITA	MECHANICAL ENGINEERING
1198	TEB16	PATIL BHAVESH HEMANT BHAVANA	MECHANICAL ENGINEERING
1199	TEB17	PATIL DEVENDRA DATTARAM PRAMILA	MECHANICAL ENGINEERING
1200	TEB18	PATIL HARISHCHANDRA SURESH KALPANA	MECHANICAL ENGINEERING
1201	TEB19	PATIL HRUTIK KISHOR LALITA	MECHANICAL ENGINEERING
1202	TEB20	PATIL MANISH ANIL VIJAYA	MECHANICAL ENGINEERING
1203	TEB21	PATIL MANTHAN SANTOSH TANUJA	MECHANICAL ENGINEERING
1204	TEB22	PATIL NIKHIL RAJENDRA ASHA	MECHANICAL ENGINEERING
1205	TEB23	PATIL PRASHANT SHESHERAO UMA	MECHANICAL ENGINEERING
1206	TEB24	PATIL PRATHAMESH PRADEEP RAJSHREE	MECHANICAL ENGINEERING
1207	TEB25	PATIL SURAJ DHANAJI ANITA	MECHANICAL ENGINEERING
1208	TEB26	PATIL TANMAY REVANNATH	MECHANICAL ENGINEERING
1209	TEB27	PATIL TUSHMESH LAXMAN VAISHALI	MECHANICAL ENGINEERING
1210	TEB28	PATIL UMESH SHRIKRISHNA NISHA	MECHANICAL ENGINEERING
1211	TEB29	PATIL VINIT ABHIMANYU MANISHA	MECHANICAL ENGINEERING
1212	TEB30	PATIL YASH SANJAY MADHUMITI	MECHANICAL ENGINEERING
1213	TEB31	PATLE KSHITIJ JAIKRISHNA JAIKRISHNA	MECHANICAL ENGINEERING
1214	TEB32	PAWAR SHUBHAM VISHAL VISHAL	MECHANICAL ENGINEERING



TRUE COPY

JKP

Principal

Vishwaniketan's (I.M.E.E.T)

1215	TEB33	PAWAR AKASH ANIL	MECHANICAL ENGINEERING
1216	TEB34	PAWAR DILIP ARUN ARUNA	MECHANICAL ENGINEERING
1217	TEB35	PAWAR KUNAL MOHAN RUPA	MECHANICAL ENGINEERING
1218	TEB36	PINJARI PRAJYOT NARAYAN SAVITA	MECHANICAL ENGINEERING
1219	TEB37	POL TUSHAR YUVRAJ SAVITA	MECHANICAL ENGINEERING
1220	TEB38	RANE OMKAR ANIL ASMITA	MECHANICAL ENGINEERING
1221	TEB39	RAUT ABHJEET MAHADEV SUREKHA	MECHANICAL ENGINEERING
1222	TEB40	RODE ONKAR HANUMANT MADHURI	MECHANICAL ENGINEERING
1223	TEB41	SALAVI SAURABH SANDIP SANJANA	MECHANICAL ENGINEERING
1224	TEB42	SALE SHREYAS SANJAY ANLALI	MECHANICAL ENGINEERING
1225	TEB43	SALUNKE ROHIT NARAYAN SAVITA	MECHANICAL ENGINEERING
1226	TEB44	SARDAL RUTVIK ARUN PRANITA	MECHANICAL ENGINEERING
1227	TEB45	SAWANT ADITYA AVINASH AKSHATA	MECHANICAL ENGINEERING
1228	TEB46	SAWANT SAURABH SUBHASH AARTI	MECHANICAL ENGINEERING
1229	TEB47	SHAIKH SAMIR JAMIL RAJIYA	MECHANICAL ENGINEERING
1230	TEB48	SHELKE RUSHIKESH DATTARAM RATAN	MECHANICAL ENGINEERING
1231	TEB49	SHELKE TUSHAR VILAS GANGUBI	MECHANICAL ENGINEERING
1232	TEB50	SHENDE SAGAR SOPAN SAVITA	MECHANICAL ENGINEERING
1233	TEB51	SHERKAR SHUBHAM SAMBHAJI ASHA	MECHANICAL ENGINEERING
1234	TEB52	SHINDE DARSHAN BHARAT NILIMA	MECHANICAL ENGINEERING
1235	TEB53	SHINDE PRATHAMESH SURESH ANAGHA	MECHANICAL ENGINEERING
1236	TEB54	SHINDE ROHIT RAMCHANDRA HARSHADA	MECHANICAL ENGINEERING
1237	TEB55	SHINDE SARVESH TULSHIDAS PRAMILA	MECHANICAL ENGINEERING
1238	TEB56	SHIRKE MIHIR RAJENDRA NUTAN RAJENDRA	MECHANICAL ENGINEERING
1239	TEB57	SHIRKE SIDDHESH BHARAT LATA	MECHANICAL ENGINEERING
1240	TEB58	SHIRSAT PRANAL AVADHUT ROSHANA	MECHANICAL ENGINEERING
1241	TEB59	SINGH ANKIT SARVESH NEELAM	MECHANICAL ENGINEERING
1242	TEB60	SINGH SAHIL PRATAP SUNITA	MECHANICAL ENGINEERING
1243	TEB61	SURYAWANSHI NIKHIL SUNIL	MECHANICAL ENGINEERING
1244	TEB62	TANDEL AMEY ANANT ANANDI	MECHANICAL ENGINEERING
1245	TEB63	THAKUR PRITESH JEEVAN SNEHA	MECHANICAL ENGINEERING
1246	TEB64	TODKAR SURAJ TANAJI SANGEETA	MECHANICAL ENGINEERING
1247	TEB65	UGALE VAIBHAV VISHNU CHHABUTAI	MECHANICAL ENGINEERING
1248	TEB66	VERMA NAGENDRA BABULAL ARCHANA	MECHANICAL ENGINEERING
1249	TEB67	VISHWAKARMA SHIVAM SHRIRAM TARA	MECHANICAL ENGINEERING
1250	TEB68	VISHWAKARMA SOURABH DWIPCHAND ULMI	MECHANICAL ENGINEERING
1251	TEB69	VITKAR ATHARVA PRASAD SWATI	MECHANICAL ENGINEERING



TRUE COPY

J.P.

Principal

Vishwaniketan's (I.M.E.E.)

1252	TEB70	WAGHE TANMAY ANIL ADITHI	MECHANICAL ENGINEERING
1253	TEB71	WAIRAGADE MAHESH PRABHAKAR RAJNI	MECHANICAL ENGINEERING
1254	TEB72	ZORE CHANDU BABU JANABAI	MECHANICAL ENGINEERING
1255	BEA01	ABHANG AAKASH	MECHANICAL ENGINEERING
1256	BEA02	ACHARYA SRIRAJ	MECHANICAL ENGINEERING
1257	BEA03	AWATE SMITESH	MECHANICAL ENGINEERING
1258	BEA04	BHAGAT HARSHI	MECHANICAL ENGINEERING
1259	BEA05	BHOSALE MAYURESH	MECHANICAL ENGINEERING
1260	BEA06	CHAVAN GANESH	MECHANICAL ENGINEERING
1261	BEA07	DHAMANE DHANANJAY	MECHANICAL ENGINEERING
1262	BEA08	DHUMAL JAYESH	MECHANICAL ENGINEERING
1263	BEA09	DOLARE PRASHANT	MECHANICAL ENGINEERING
1264	BEA10	GAVALI SIDDHESH	MECHANICAL ENGINEERING
1265	BEA11	GHARAT SAISHWAR	MECHANICAL ENGINEERING
1266	BEA12	GHORPADE SUBODH	MECHANICAL ENGINEERING
1267	BEA13	GHULE ATUL	MECHANICAL ENGINEERING
1268	BEA14	GIRI ROHIT	MECHANICAL ENGINEERING
1269	BEA15	GODSE OMKAR	MECHANICAL ENGINEERING
1270	BEA16	GORE ROHIT	MECHANICAL ENGINEERING
1271	BEA17	GOYAL CHIRAG	MECHANICAL ENGINEERING
1272	BEA18	GUNJAL SARVESH	MECHANICAL ENGINEERING
1273	BEA19	GURAV NIKHIL	MECHANICAL ENGINEERING
1274	BEA20	HULGE ANIKET	MECHANICAL ENGINEERING
1275	BEA21	JADHAV NIKHIL RAJENDRA	MECHANICAL ENGINEERING
1276	BEA22	KOLI RUSHIKESH	MECHANICAL ENGINEERING
1277	BEA23	KONJE KALPESH	MECHANICAL ENGINEERING
1278	BEA24	MALIEKAL JITHIN	MECHANICAL ENGINEERING
1279	BEA25	MAYEKAR PRATIK	MECHANICAL ENGINEERING
1280	BEA26	MHATRE AADARSH	MECHANICAL ENGINEERING
1281	BEA27	MHATRE NISHANT	MECHANICAL ENGINEERING
1282	BEA28	MHATRE VINAY	MECHANICAL ENGINEERING
1283	BEA29	NANGARE SHUBHAM	MECHANICAL ENGINEERING
1284	BEA30	NARAYANKAR NAVIN	MECHANICAL ENGINEERING
1285	BEA31	PAGADE RAJ	MECHANICAL ENGINEERING
1286	BEA32	PARAB TUSHAR	MECHANICAL ENGINEERING
1287	BEA33	PARDESI ABHISHEK	MECHANICAL ENGINEERING
1288	BEA34	PATIL ABHISHEK	MECHANICAL ENGINEERING

TRUE COPY

[Handwritten Signature]

Principal
Vishwanathrao S. MEET

1289	BEA35	PATIL JAYESH	MECHANICAL ENGINEERING
1290	BEA36	PATIL PRATHMESH	MECHANICAL ENGINEERING
1291	BEA37	PATIL SAURABH	MECHANICAL ENGINEERING
1292	BEA38	PATIL SHUBHAM	MECHANICAL ENGINEERING
1293	BEA39	PISAL VAIBHAV	MECHANICAL ENGINEERING
1294	BEA40	RAJGURU PIYUSH	MECHANICAL ENGINEERING
1295	BEA41	RAMDHARNE MANISH	MECHANICAL ENGINEERING
1296	BEA42	RANE RUSHIKESH	MECHANICAL ENGINEERING
1297	BEA43	RAUT RUSHIKESH	MECHANICAL ENGINEERING
1298	BEA44	RAUT TABISH	MECHANICAL ENGINEERING
1299	BEA45	SALUNKHE ANKUR	MECHANICAL ENGINEERING
1300	BEA46	SANE GANESH	MECHANICAL ENGINEERING
1301	BEA47	SASTE VIKIN	MECHANICAL ENGINEERING
1302	BEA48	SHINDE MAYUR	MECHANICAL ENGINEERING
1303	BEA49	SHINDE PRATHAMESH	MECHANICAL ENGINEERING
1304	BEA50	SHINDE SAHIL	MECHANICAL ENGINEERING
1305	BEA51	SONAWANE VEDANT	MECHANICAL ENGINEERING
1306	BEA52	THAKUR BHUVANESH	MECHANICAL ENGINEERING
1307	BEA53	THAKUR SANKET	MECHANICAL ENGINEERING
1308	BEA54	THALE PRIYAJ	MECHANICAL ENGINEERING
1309	BEA55	TIWARE PRANAY	MECHANICAL ENGINEERING
1310	BEA56	UMBARKAR AJAY	MECHANICAL ENGINEERING
1311	BEA57	UTALE NIKHIL	MECHANICAL ENGINEERING
1312	BEA58	UTTEKAR NIKHIL	MECHANICAL ENGINEERING
1313	BEA59	SANAP PARMESHWER	MECHANICAL ENGINEERING
1314	BEA60	JADHAV NILESH RAJARAM	MECHANICAL ENGINEERING
1315	BEA61	TARADE MAYUR	MECHANICAL ENGINEERING
1316	BEA62	PATIL PRANIT NARAYAN	MECHANICAL ENGINEERING
1317	BEA63	KUTE SHUBHAM	MECHANICAL ENGINEERING
1318	BEA64	JAMBHALE RAHUL	MECHANICAL ENGINEERING
1319	BEA65	JADHAV ANIKET	MECHANICAL ENGINEERING
1320	BEA66	CHALKE RUSHIKESH	MECHANICAL ENGINEERING
1321	BEA67	AMBURLE SWAPNIL	MECHANICAL ENGINEERING
1322	BEA68	NADAR RENJITH	MECHANICAL ENGINEERING
1323	BEA69	PATIL BHAVESH	MECHANICAL ENGINEERING
1324	BEA70	JAGDALE AKSHAY	MECHANICAL ENGINEERING
1325	BEA71	CHIRNERKAR ABHIJIT	MECHANICAL ENGINEERING

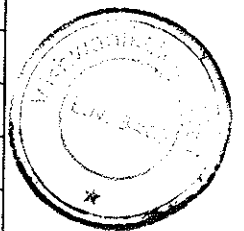

TRUE COPY

[Signature]
Principal
Vishwanath's (P) MEET

1326	BEA72	KOLEKAR AVINASH	MECHANICAL ENGINEERING
1327	BEA73	SUGANDHI RAJEEV	MECHANICAL ENGINEERING
1328	BEB01	ADATE RAHUL	MECHANICAL ENGINEERING
1329	BEB02	ATHAWALE HIRSHIKESH	MECHANICAL ENGINEERING
1330	BEB03	BALMIKI RACHANA	MECHANICAL ENGINEERING
1331	BEB04	BAWASKAR SIMRAN	MECHANICAL ENGINEERING
1332	BEB05	BHOIR SHUBHAM	MECHANICAL ENGINEERING
1333	BEB06	CHAVAN SAMBHAJI	MECHANICAL ENGINEERING
1334	BEB07	DABHANE JAGDISH	MECHANICAL ENGINEERING
1335	BEB08	DESHMUKH KALPESH	MECHANICAL ENGINEERING
1336	BEB09	DHOOTE VIDYADHAR	MECHANICAL ENGINEERING
1337	BEB10	DOIPHODE AKASH	MECHANICAL ENGINEERING
1338	BEB11	GAIKWAD CHETAN	MECHANICAL ENGINEERING
1339	BEB12	GAIKWAD PRATIK	MECHANICAL ENGINEERING
1340	BEB13	GAMARE SAURABH	MECHANICAL ENGINEERING
1341	BEB14	GHARAT UTKARSH	MECHANICAL ENGINEERING
1342	BEB15	GORDE PRASHANT	MECHANICAL ENGINEERING
1343	BEB16	HAWARE HRUSHIKESH	MECHANICAL ENGINEERING
1344	BEB17	JADHAV MAYUR	MECHANICAL ENGINEERING
1345	BEB18	KADAM SURAJ	MECHANICAL ENGINEERING
1346	BEB19	KAMBLE RUSHIKESH	MECHANICAL ENGINEERING
1347	BEB20	KHEDKAR PRANAL	MECHANICAL ENGINEERING
1348	BEB21	MALI RUSHIKESH	MECHANICAL ENGINEERING
1349	BEB22	MALUSARE SNEHA	MECHANICAL ENGINEERING
1350	BEB23	MANDHARE PRATIK	MECHANICAL ENGINEERING
1351	BEB24	MESTRI PRASAD	MECHANICAL ENGINEERING
1352	BEB25	MHATRE RUSHABH	MECHANICAL ENGINEERING
1353	BEB26	MHATRE SNEHA	MECHANICAL ENGINEERING
1354	BEB27	MOJAR SANKET	MECHANICAL ENGINEERING
1355	BEB28	NAIKWADE MITHLESHA	MECHANICAL ENGINEERING
1356	BEB29	NIKAM CHAITANYA	MECHANICAL ENGINEERING
1357	BEB30	NIVETKAR YASH	MECHANICAL ENGINEERING
1358	BEB31	PAKHARE ADITYA	MECHANICAL ENGINEERING
1359	BEB32	PALASKAR VISHAL	MECHANICAL ENGINEERING
1360	BEB33	PATARE SWAPNIL	MECHANICAL ENGINEERING
1361	BEB34	PATIL PRATIKSHA	MECHANICAL ENGINEERING
1362	BEB35	PATIL TANAMAY	MECHANICAL ENGINEERING



TRUE COPY

J.P.

Principal

Vishwaniketan's (i MEET)

1363	BEB36	PAWAR NIKHIL	MECHANICAL ENGINEERING
1364	BEB37	SAWANT BHUSHAN	MECHANICAL ENGINEERING
1365	BEB38	SHINDE YASHI	MECHANICAL ENGINEERING
1366	BEB39	SHUKLA ABHISHEK	MECHANICAL ENGINEERING
1367	BEB40	SINGH AMIT	MECHANICAL ENGINEERING
1368	BEB41	SUNKA VIJAY	MECHANICAL ENGINEERING
1369	BEB42	TEMBARE PRITAM	MECHANICAL ENGINEERING
1370	BEB43	THALE SANKET	MECHANICAL ENGINEERING
1371	BEB44	THOMBARE SANKET	MECHANICAL ENGINEERING
1372	BEB45	VEDAK HARSHI	MECHANICAL ENGINEERING
1373	BEB46	WADHAVE AKASH	MECHANICAL ENGINEERING
1374	BEB47	CHAVAN PRATIK	MECHANICAL ENGINEERING
1375	BEB48	DESHMUKH DARSHAN	MECHANICAL ENGINEERING
1376	BEB49	DESHPANDE YOGIRAJ	MECHANICAL ENGINEERING
1377	BEB50	MHATRE JAYESH	MECHANICAL ENGINEERING
1378	BEB51	MHATRE SANKET	MECHANICAL ENGINEERING
1379	BEB52	MONDKAR SANDEEP	MECHANICAL ENGINEERING
1380	BEB53	MULAY MAHESH	MECHANICAL ENGINEERING
1381	BEB54	OWAL HRUTVIK	MECHANICAL ENGINEERING
1382	BEB55	PATIL SHANTANU	MECHANICAL ENGINEERING
1383	BEB56	PAWAR ANIKET	MECHANICAL ENGINEERING
1384	BEB57	PEDGE JALINDAR	MECHANICAL ENGINEERING
1385	BEB58	PHADKE ROHIT	MECHANICAL ENGINEERING
1386	BEB59	SAGWEKAR SHUBHAM	MECHANICAL ENGINEERING
1387	BEB60	SHEJALE SHUBHAM	MECHANICAL ENGINEERING
1388	BEB61	VEER TUSHAR	MECHANICAL ENGINEERING

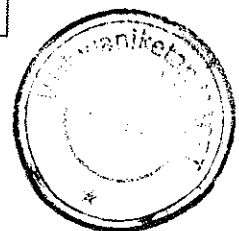

TRUE COPY

JKP
Principal
Vishwaniketan's (i MEET)



VISHWANIKETAN

Institute of Management Entrepreneurship and Engineering Technology

Survey No-52 Off Mumbai-Pune Expressway Kumbhivali,

Tal- Khalapur, Maharashtra 410203.

Phone: (02192) 274206/274207/274208/274210

2020-2021

Sr. No.	Roll No.	Name of Student	Name of Program
1	SE01	ABDAR SWAPNIL DEVIDAS SANGITA	CIVIL ENGINEERING
2	SE02	AMBEKAR ROHIT SURESH SUSHAMA	CIVIL ENGINEERING
3	SE03	AVILAD DNYANESHWAR DIGAMBAR MANDAKIN	CIVIL ENGINEERING
4	SE04	BADE AVINASH VIJAY MANGAL	CIVIL ENGINEERING
5	SE05	BHILARE SIDDHANT SANJAY USHA	CIVIL ENGINEERING
6	SE06	BHOIR SANKET GANGARAM SUJATA	CIVIL ENGINEERING
7	SE07	BIRADAR ABHIJEET SHANTKUMAR JYOTI	CIVIL ENGINEERING
8	SE08	DAREKAR PRATHAM ANIL MEENA	CIVIL ENGINEERING
9	SE09	DHAMALE SUSHIL SUNIL ASHA	CIVIL ENGINEERING
10	SE10	GADAGE DEEPAK KONDIBA SHAKUNTALA	CIVIL ENGINEERING
11	SE11	GAIKWAD AKASH VASANT KALPANA	CIVIL ENGINEERING
12	SE12	GAIKWAD RHEA SUNIL MEENA	CIVIL ENGINEERING
13	SE13	GAVAND TANMAY KESHVINATH GEETA	CIVIL ENGINEERING
14	SE14	GAWAND DURVAL GAJANAN DHANSHRI	CIVIL ENGINEERING
15	SE15	GHARAT ANVAY RAVINDRA SAMPADA	CIVIL ENGINEERING
16	SE16	GUPTA RAJESH UTTAM AMBIKA	CIVIL ENGINEERING
17	SE17	JADHAV ANAND DILIP MINAL	CIVIL ENGINEERING
18	SE18	JADHAV ANIKET DEVRAM VAISHALI	CIVIL ENGINEERING
19	SE19	JADHAV DARSHAN PRAKASH SHUBHANGI	CIVIL ENGINEERING
20	SE20	JADHAV RAJENDRA PANDURANG PRATIBHA	CIVIL ENGINEERING
21	SE21	KAMBLE SIDDHIRAJ GAUTAM MAHADEVI	CIVIL ENGINEERING
22	SE22	KARDAK SIDDHANT SHYAM USHA	CIVIL ENGINEERING
23	SE23	KHADE VISHAL BALIRAM SUJATA	CIVIL ENGINEERING
24	SE24	KOHINOORKAR RAJESH DEVINDRA SAVITA	CIVIL ENGINEERING
25	SE25	LIGAM AAKASH CHANDRAKANT POOJA	CIVIL ENGINEERING
26	SE26	MHATRE AAKASH GANGARAM AMITA	CIVIL ENGINEERING
27	SE27	MHATRE ANIKET CHANDRAKANT SUVARNA	CIVIL ENGINEERING
28	SE28	MHATRE DARSHAN MANOHAR MANISHA	CIVIL ENGINEERING
29	SE29	MHATRE NITESH GANESH SUGANDHA	CIVIL ENGINEERING
30	SE30	MORE AISHWARYA MILIND ARCHANA	CIVIL ENGINEERING
31	SE31	MUNDHE KSHITHI BHARAT MANGAL	CIVIL ENGINEERING

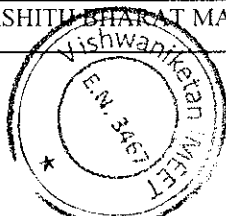

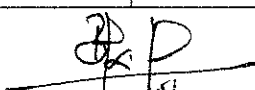
TRUE COPY

Vishwaniketan (I MEET)

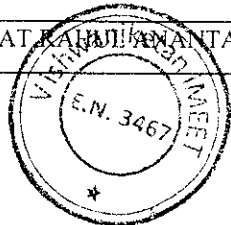
32	SE32	NAYAK SUBRAT KUMAR SANJAY KUMAR SABITA	CIVIL ENGINEERING
33	SE33	PALKAR AKSHAY KAILAS POOJA POOJA	CIVIL ENGINEERING
34	SE34	PALRECHA PRAJWAL INDRAMAL CHETANA	CIVIL ENGINEERING
35	SE35	PALVE NITESH GANGARAM KALPANA	CIVIL ENGINEERING
36	SE36	PANDIT ADITYA DAYANAND KAVITA	CIVIL ENGINEERING
37	SE37	PATIL ABHIRAJ MAHENDRA TANUJA	CIVIL ENGINEERING
38	SE38	PATIL KALPESH PRABHAKAR MANGAL	CIVIL ENGINEERING
39	SE39	PATIL SHRUTEE SUDHAKAR SAVITA	CIVIL ENGINEERING
40	SE40	PAWAR PRANAV GIRISH VIJAYA	CIVIL ENGINEERING
41	SE41	PAWAR RUTUJA RAJENDRA MANGALA	CIVIL ENGINEERING
42	SE42	PINGALA PRIYANKA KRUSHNA JANAKI	CIVIL ENGINEERING
43	SE43	POOJARY SAMANTH SUDHAKAR MANJULA	CIVIL ENGINEERING
44	SE44	SANKPAL GAURAV SANTOSHI CHANDRABHAGA	CIVIL ENGINEERING
45	SE45	SATVE YASH CHANDRAKNAT SEEMA	CIVIL ENGINEERING
46	SE46	SHARMA SHIVDUTT MANOJ VINITA SHARMA	CIVIL ENGINEERING
47	SE47	SHID MAHESH RAMESH HIRA	CIVIL ENGINEERING
48	SE48	SHIRKE JAYESH RAMDAS REKHA	CIVIL ENGINEERING
49	SE49	SORATHIA ALFAIEZ IQBAL MEHMUDA	CIVIL ENGINEERING
50	SE50	SURYAVANSHI PRATHAMESH SHIVAJI ARCHANA	CIVIL ENGINEERING
51	SE51	TALKAR SURAJ SUDHAKAR SUVIDHA	CIVIL ENGINEERING
52	SE52	TERDE HIMANSHU PRAKASH NAYANA	CIVIL ENGINEERING
53	SE53	THORAT TANMAY PANDIT SHOBHA	CIVIL ENGINEERING
54	SE54	TUMMA HARISH CHINNAPENTAI AH PRAMILA	CIVIL ENGINEERING
55	SE55	UGHADA NANA KAMALU SITA SITA	CIVIL ENGINEERING
56	TEA01	BAGUL OM	CIVIL ENGINEERING
57	TEA02	BANDGAR VISHVAS BALU	CIVIL ENGINEERING
58	TEA03	BUDHE VAIBHAV JAGADISH	CIVIL ENGINEERING
59	TEA04	CHAVARKAR ADWAIT SANJAY	CIVIL ENGINEERING
60	TEA05	DESHMUKH GANESH	CIVIL ENGINEERING
61	TEA06	DESHMUKH PRASHANT SHIVAJIRAO	CIVIL ENGINEERING
62	TEA07	DHANAWADE SANDESH DATTATRAY	CIVIL ENGINEERING
63	TEA08	DHOLAKIA VIREN	CIVIL ENGINEERING
64	TEA09	GAIKWAD ABHIJEET SOPAN	CIVIL ENGINEERING
65	TEA10	GAIKWAD AKSHAY MAHENDRA	CIVIL ENGINEERING
66	TEA11	GAIKWAD KETAN RAJESH	CIVIL ENGINEERING
67	TEA12	GAIKWAD SHUBHAM ANANTA	CIVIL ENGINEERING
68	TEA13	GAVAT KALPANA ANANTA	CIVIL ENGINEERING



TRUE COPY
 J.P.P.
 Principal
 Vishwanthetan's (i MEET)

69	TEA14	JADHAV AVISHIKAR ASHOK	CIVIL ENGINEERING
70	TEA15	JADHAV SAHIL SANDIP	CIVIL ENGINEERING
71	TEA16	JADHAV SANKET	CIVIL ENGINEERING
72	TEA17	JANGAM ROHAN RAVINDRA	CIVIL ENGINEERING
73	TEA18	JOSHI SAGAR SANTOSH	CIVIL ENGINEERING
74	TEA19	KADAM PRANAY PRAMOD	CIVIL ENGINEERING
75	TEA20	KAPURE SUDEEP K	CIVIL ENGINEERING
76	TEA21	KULKARNI PRATHMESH PRADIP	CIVIL ENGINEERING
77	TEA22	M.S MELVIN ABHIJIT	CIVIL ENGINEERING
78	TEA23	MAHAJAN ADITYA SUNIL	CIVIL ENGINEERING
79	TEA24	MANE GANESH BABASABEB	CIVIL ENGINEERING
80	TEA25	MANE PRIYANKA MOHAN	CIVIL ENGINEERING
81	TEA26	MEHER SHUBHAM NANDKUMAR	CIVIL ENGINEERING
82	TEA27	MEMAN SAHIL ALTAF	CIVIL ENGINEERING
83	TEA28	MHATRE RITESH RAVINDRA	CIVIL ENGINEERING
84	TEA29	MISHRA SARTHAK	CIVIL ENGINEERING
85	TEA30	MOHAMMAD AMAN KHAN	CIVIL ENGINEERING
86	TEA31	MORE DHIRAJ DNYANESHWAR	CIVIL ENGINEERING
87	TEA32	NIKALJE ABHISHEK	CIVIL ENGINEERING
88	TEA33	PATIL ROHIT PRATAPRAO	CIVIL ENGINEERING
89	TEA34	SALUNKE RUSHIKESH RAMLING	CIVIL ENGINEERING
90	TEA35	SHAH PARTH NIMISH	CIVIL ENGINEERING
91	TEA36	VARTAK SHUBHAM DEVIDAS	CIVIL ENGINEERING
92	TEA37	VARTAK SHUBHAM PRAVIN	CIVIL ENGINEERING
93	TEA38	WAGH YASH SANJAY	CIVIL ENGINEERING
94	TEA39	BAIS SARTHAK KACHRUSINGH	CIVIL ENGINEERING
95	TEA40	BANDAL MANGESH VIJAY	CIVIL ENGINEERING
96	TEA41	BEHERA FALESHWAR JAYARAM	CIVIL ENGINEERING
97	TEA42	BHALERAO MAYURI RAJU	CIVIL ENGINEERING
98	TEA43	BHALERAO MEGHA RAJU	CIVIL ENGINEERING
99	TEA44	BHOSALE PRAVIN SARJERAO	CIVIL ENGINEERING
100	TEA45	BHUSANE SAHIL ASHOK	CIVIL ENGINEERING
101	TEA46	BURKUL SANDESH SIDRAM	CIVIL ENGINEERING
102	TEA47	CHAVAN SACHIN VISHNU	CIVIL ENGINEERING
103	TEA48	CHAVAN SHREYASH SHRIKANT	CIVIL ENGINEERING
104	TEA49	CHAVAN SHRIDHAR SHRIPATI	CIVIL ENGINEERING
105	TEA50	CHOUHARY VIKAS NARENDAR	CIVIL ENGINEERING

TRUE COPY

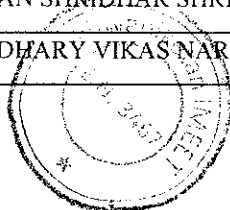

[Signature]
Principal
Vishwanath's (i) MEET

106	TEA51	DALVE ABHISHEK NAMDEV	CIVIL ENGINEERING
107	TEA52	DALVI PRATIK PANDURANG	CIVIL ENGINEERING
108	TEA53	DALVI SHUBHAM SANTOSH	CIVIL ENGINEERING
109	TEA54	DEMANE MRUNAL RAJESH	CIVIL ENGINEERING
110	TEA55	DESHPANDE SUYASH YESHWANT	CIVIL ENGINEERING
111	TEA56	DHARANE KETAKI SURESH	CIVIL ENGINEERING
112	TEA57	DHUMAL POOJA SANJAY	CIVIL ENGINEERING
113	TEA58	DOMB BALRAJ MADHUKAR	CIVIL ENGINEERING
114	TEA59	GAIKWAD TEJASHREE GANESH	CIVIL ENGINEERING
115	TEA60	GHOLAP SAURABH SANJAY	CIVIL ENGINEERING
116	TEA61	GUJAR ADITYA DNYANESHWAR	CIVIL ENGINEERING
117	TEA62	GUNJAL NEHAL PRAMOD	CIVIL ENGINEERING
118	TEA63	HALSE PRAVEEN JAIPRAKASH	CIVIL ENGINEERING
119	TEA64	HAMBIR JANARDAN JANU	CIVIL ENGINEERING
120	TEA65	JADHAV ADITYA HARESH	CIVIL ENGINEERING
121	TEA66	JADHAV SHIVCHARAN H	CIVIL ENGINEERING
122	TEA67	JADHAV VISHAL DILIP	CIVIL ENGINEERING
123	TEA68	JANGAM AKSHAY ANIL	CIVIL ENGINEERING
124	TEA69	KADAM HEMANGI DEVIDAS	CIVIL ENGINEERING
125	TEA70	KADAM LILADHAR NAGESH	CIVIL ENGINEERING
126	TEA71	KADAM NIRAJ RAJESH	CIVIL ENGINEERING
127	TEA72	KADAM SONAL NARAYAN	CIVIL ENGINEERING
128	TEA73	KAMBLE SONALI DEEPAK	CIVIL ENGINEERING
129	TEA74	KARALE NISHANT ARVIND	CIVIL ENGINEERING
130	TEA75	KHARATMAL TEJAS SURESH	CIVIL ENGINEERING
131	TEA76	KHARATMOL AKASH PANDURANG	CIVIL ENGINEERING
132	TEA77	KOLHE SAKSHI JITENDRA	CIVIL ENGINEERING
133	TEA78	KOLI VIRESH HARESH	CIVIL ENGINEERING
134	TEA79	KOTHARI NAYAN YOGESH	CIVIL ENGINEERING
135	TEA80	KURE HITESH SANDEEP	CIVIL ENGINEERING
136	TEA81	KURLE VAIBHAV UTTAM	CIVIL ENGINEERING
137	TEA82	LAD SIDDHESH NANDKUMAR	CIVIL ENGINEERING
138	TEA83	MAKAJI RUTIK GAJANAN	CIVIL ENGINEERING
139	TEB01	MALVANKAR KARAN VIJAY	CIVIL ENGINEERING
140	TEB02	MHAMUNKR RAJ JAYWANT	CIVIL ENGINEERING
141	TEB03	MHATRE NEELIMA BHANUDAS	CIVIL ENGINEERING
142	TEB04	MISAL MAHESH GUNDHAV	CIVIL ENGINEERING



TRUE COPY

Vishwanath's (I) MEET

143	TEB05	MISHRA ADITYANATH LALANKUMAR	CIVIL ENGINEERING
144	TEB06	MITHAGARE MAYUR NANDKUMAR	CIVIL ENGINEERING
145	TEB07	MOHITE ATUL RAHUL	CIVIL ENGINEERING
146	TEB08	MOHITE SWATI SANDEEP	CIVIL ENGINEERING
147	TEB09	MORE MANTHAN SHIRISH	CIVIL ENGINEERING
148	TEB10	MORE PRATHAMESH TANAJI	CIVIL ENGINEERING
149	TEB11	MORE SHRUTI SANTOSH	CIVIL ENGINEERING
150	TEB12	MULIK PRATIK BAPUSAB	CIVIL ENGINEERING
151	TEB13	MULLA USAMA HANIF	CIVIL ENGINEERING
152	TEB14	NAIK CHINMAY SANTOSH	CIVIL ENGINEERING
153	TEB15	NAIK PRATIK EKNATH	CIVIL ENGINEERING
154	TEB16	NIKAM NIKHIL ANKUSH	CIVIL ENGINEERING
155	TEB17	NIMBALKAR HRUTVIKA AVINASH	CIVIL ENGINEERING
156	TEB18	PALVE AKASH VINAYAK	CIVIL ENGINEERING
157	TEB19	PANDHARE HRUTUJA TAYAPPA	CIVIL ENGINEERING
158	TEB20	PARAMMAL ABHINAV THAMBAN	CIVIL ENGINEERING
159	TEB21	PARANGE ROHAN LILADHAR	CIVIL ENGINEERING
160	TEB22	PARDESHI MOHITE B	CIVIL ENGINEERING
161	TEB23	PASWAN NIKET RAJENDRA	CIVIL ENGINEERING
162	TEB24	PATIL ABHIJEET AVINASH	CIVIL ENGINEERING
163	TEB25	PATIL AVADHOOT SANTOSH	CIVIL ENGINEERING
164	TEB26	PATIL HRITIK GAJANAN	CIVIL ENGINEERING
165	TEB27	PATIL JAIRAJ RAVINDRA	CIVIL ENGINEERING
166	TEB28	PATIL KAPIL GAJANAN GITANJALI	CIVIL ENGINEERING
167	TEB29	PATIL KAVISH RAJENDRA	CIVIL ENGINEERING
168	TEB30	PATIL MAHESH KASHINATH	CIVIL ENGINEERING
169	TEB31	PATIL NAMISH SOMNATH	CIVIL ENGINEERING
170	TEB32	PATIL PRAJWAL ARVIND	CIVIL ENGINEERING
171	TEB33	PATIL PRASAD SANTOSH	CIVIL ENGINEERING
172	TEB34	PATIL PRASAD VILAS	CIVIL ENGINEERING
173	TEB35	PATIL RUSHIKESH ANANDA	CIVIL ENGINEERING
174	TEB36	PATIL RUTUJA ARAVIND	CIVIL ENGINEERING
175	TEB37	PATIL SHRIYASH SHRIKANT	CIVIL ENGINEERING
176	TEB38	PATIL SHUBHAM ASHOK	CIVIL ENGINEERING
177	TEB39	PATIL SUDHIR HANUMANT	CIVIL ENGINEERING
178	TEB40	PATIL SWAPNALL KISHOR	CIVIL ENGINEERING
179	TEB41	PATIL YASHRAJ RAMESH	CIVIL ENGINEERING

TRUE COPY

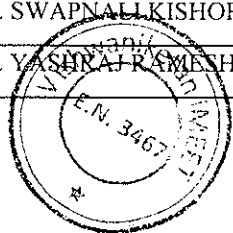

[Signature]
Principal

Vishwaniketan's (J.M.E.E.T.)

180	TEB42	PAWAR HARSHAL HANUMANT	CIVIL ENGINEEING
181	TEB43	PAWAR MANOJ NANDU	CIVIL ENGINEEING
182	TEB44	PAWAR SANKET BHAGWAN	CIVIL ENGINEEING
183	TEB45	PORE MITALI MAHESH	CIVIL ENGINEEING
184	TEB46	POWAR RAHUL BHIMRAO	CIVIL ENGINEEING
185	TEB47	QADRI HANZALA MOHAMMED JUNAID	CIVIL ENGINEEING
186	TEB48	QUADRI ABDULKADIR FAIYYAZAMED	CIVIL ENGINEEING
187	TEB49	RAUT AKANKSHA NISHIKANT	CIVIL ENGINEEING
188	TEB50	SABLE GAURAV SANTOSHI	CIVIL ENGINEEING
189	TEB51	SAHA KRISHNA SUKLAL	CIVIL ENGINEEING
190	TEB52	SAKPAL AMAR HANUMANT	CIVIL ENGINEEING
191	TEB53	SALUNKE SAYALI SUNIL	CIVIL ENGINEEING
192	TEB54	SALVI PRATIK PRAFULL	CIVIL ENGINEEING
193	TEB55	SAWANT HERAMB RAM	CIVIL ENGINEEING
194	TEB56	SAWANT LATIKA EKANATH	CIVIL ENGINEEING
195	TEB57	SHAH BRIJESH HARESH	CIVIL ENGINEEING
196	TEB58	SHAIKH FARDEEN ASIFUDDIN	CIVIL ENGINEEING
197	TEB59	SHAIKH PARVEJ MOHMADSHARIF	CIVIL ENGINEEING
198	TEB60	SHARMA TARUN SANJAY	CIVIL ENGINEEING
199	TEB61	SHIGWAN SAURABH RAMESH	CIVIL ENGINEEING
200	TEB62	SHINDE KIRAN KISHOR	CIVIL ENGINEEING
201	TEB63	SHINDE PRAKASH UDDHAV ASHA	CIVIL ENGINEEING
202	TEB64	SHIRKE SIDDHESH DATTA	CIVIL ENGINEEING
203	TEB65	SINGH SACHIN SHIVLAL KIRAN	CIVIL ENGINEEING
204	TEB66	SINGH SANJIVKUMAR UMASHANKAR	CIVIL ENGINEEING
205	TEB67	SINHA SHIVAM PRADEEP	CIVIL ENGINEEING
206	TEB68	SONAWANE RUPALI RANGANATH	CIVIL ENGINEEING
207	TEB69	SURYAVANSHI AMOL ANURATHRAO	CIVIL ENGINEEING
208	TEB70	TATHARE SHRUTI VINAYAK	CIVIL ENGINEEING
209	TEB71	THAIL HEMANT APINATH	CIVIL ENGINEEING
210	TEB72	THAKUR SAHIL JAYWANT	CIVIL ENGINEEING
211	TEB73	THUPPADA HARISH NARAYAN	CIVIL ENGINEEING
212	TEB74	UKARANDE OMKAR VILAS	CIVIL ENGINEEING
213	TEB75	WAGHAMARE RAJESH GANPAT	CIVIL ENGINEEING
214	TEB76	YADAV AKHILESH BAPU	CIVIL ENGINEEING
215	TEB77	DHANAWADE OMKAR SANJAY	CIVIL ENGINEEING
216	TEB78	JADHAV SAHIL RAJESH	CIVIL ENGINEEING

TRUE COPY

[Signature]
Principal

Vishwanthetan's (I MEET)



217	TEB79	SALUNKE AKSHAY SURESH ARUNA	CIVIL ENGINEEING
218	TEB80	SONAWANE SHUBHAM DATTATRAY	CIVIL ENGINEEING
219	TEB81	SURAJ KAILAS KARCHE	CIVIL ENGINEEING
220	TEB82	WASKAR SUHAS RAMAN SANGHETA	CIVIL ENGINEEING
221	TEB83	YEDEKAR SAURABH VASANT	CIVIL ENGINEEING
222	BEA01	ACHARYA VARUN GANPAT	CIVIL ENGINEEING
223	BEA02	AHIRRAO SNEHA RAJARAM	CIVIL ENGINEEING
224	BEA03	AMANE PRADYUMNA SHIVANAND	CIVIL ENGINEEING
225	BEA04	BARASKAR DEVYANI	CIVIL ENGINEEING
226	BEA05	BASARE SHRADDHA	CIVIL ENGINEEING
227	BEA06	BATHIJA KUNAL R.	CIVIL ENGINEEING
228	BEA07	BEDSE JAYESH DIPAK	CIVIL ENGINEEING
229	BEA08	BELOTE VISHAL PAPPU	CIVIL ENGINEEING
230	BEA09	BHAGAT DHAVAL DINESH	CIVIL ENGINEEING
231	BEA10	BHAGAT PRANAY	CIVIL ENGINEEING
232	BEA11	BHAGAT SARVESH JAGDISH	CIVIL ENGINEEING
233	BEA12	BHAT WASEEM	CIVIL ENGINEEING
234	BEA13	BHORING SAGAR MANUBHAI	CIVIL ENGINEEING
235	BEA14	BHUJBAL MEGHA DINKAR	CIVIL ENGINEEING
236	BEA15	BORKAR ADITYA PRADEEP	CIVIL ENGINEEING
237	BEA16	BUGADE SACHIN TANAJI	CIVIL ENGINEEING
238	BEA17	CHAUDHARY SHEFALI HEMANT	CIVIL ENGINEEING
239	BEA18	CHAVARE TANVI	CIVIL ENGINEEING
240	BEA19	CHAVHAN SWARAJ VISHWAS	CIVIL ENGINEEING
241	BEA20	CHOUDHARI DARSHAN ANIL	CIVIL ENGINEEING
242	BEA21	DALVI NINAD NAMDEO	CIVIL ENGINEEING
243	BEA22	DAMARE RITESH TANAJI	CIVIL ENGINEEING
244	BEA23	DANDEKAR NIKHIL JAYENDRA	CIVIL ENGINEEING
245	BEA24	DAYANAND SUBHASH INDUBAI	CIVIL ENGINEEING
246	BEA25	DESHMUKH PRATHMESH NARESH	CIVIL ENGINEEING
247	BEA26	DESHMUKH ANKITA VIKAS	CIVIL ENGINEEING
248	BEA27	DESHMUKH SHUBHAM SANJAY	CIVIL ENGINEEING
249	BEA28	DHAWALE GITANJLI GOVIND	CIVIL ENGINEEING
250	BEA29	DHEMBRE PRATHMESH APPASAHEB	CIVIL ENGINEEING
251	BEA30	DHOKALE BALAJI DADASAHEB	CIVIL ENGINEEING
252	BEA31	DHUMAL GANESH RAJENDRA	CIVIL ENGINEEING
253	BEA32	FERNANDES ALVES	CIVIL ENGINEEING

TRUE COPY



[Signature]
Principal
Vishwaniketan's (I MEET)

254	BEA33	GADADE SHUBHAM BIRUDEO	CIVIL ENGINEERING
255	BEA34	GAIKWAD KALPESH LAXMAN	CIVIL ENGINEERING
256	BEA35	GAIKWAD ANKITA ASHOK	CIVIL ENGINEERING
257	BEA36	GAIKWAD SARTHAK SAGAR	CIVIL ENGINEERING
258	BEA37	GARDI OMKAR NARENDRA	CIVIL ENGINEERING
259	BEA38	GAVATE HITESH JANARDAN NILIMA	CIVIL ENGINEERING
260	BEA39	GAWADE VAIBHAV SUBHASH	CIVIL ENGINEERING
261	BEA40	GAWALI PRASHANT ARJUN	CIVIL ENGINEERING
262	BEA41	GAWAND DIVYA DINANATHI	CIVIL ENGINEERING
263	BEA42	GHADGE SANDESH RAJENDRA	CIVIL ENGINEERING
264	BEA43	GHADI NIKHIL PRAMOD	CIVIL ENGINEERING
265	BEA44	GHARAT VRUSHALI SHIRISH	CIVIL ENGINEERING
266	BEA45	GHARAT DIWANGI MANOJ	CIVIL ENGINEERING
267	BEA46	GHASTI PRANAY SANJAY	CIVIL ENGINEERING
268	BEA47	GHAVATE RAJ ANIL	CIVIL ENGINEERING
269	BEA48	GOSAVI HRUSHIKESH SHRIRAM	CIVIL ENGINEERING
270	BEA49	GUJAR SHUBHAM ANIL	CIVIL ENGINEERING
271	BEA50	GURAO GAYATRI ANKUSH	CIVIL ENGINEERING
272	BEA51	GURAV NIKHIL UDAY	CIVIL ENGINEERING
273	BEA52	HAJARE VAIBHAV SURESH	CIVIL ENGINEERING
274	BEA53	HANDE RUSHIKESH RAMCHANDRA	CIVIL ENGINEERING
275	BEA54	HIRTHICK BHARANI	CIVIL ENGINEERING
276	BEA55	INARKAR ANKUSH	CIVIL ENGINEERING
277	BEA56	INKAR TEJAS RAHUL	CIVIL ENGINEERING
278	BEA57	JADHAV AKSHAY RAMESH	CIVIL ENGINEERING
279	BEA58	JADHAV NIKHIL KAILAS	CIVIL ENGINEERING
280	BEA59	JADHAV NILESH MURALI	CIVIL ENGINEERING
281	BEA60	JADHAV RAHUL SHANKAR	CIVIL ENGINEERING
282	BEA61	JADHAV RAJKUMAR SUNIL	CIVIL ENGINEERING
283	BEA62	JADHAV SARVESH SANDEEP	CIVIL ENGINEERING
284	BEA63	JADHAV SHIVANI ANANT	CIVIL ENGINEERING
285	BEA64	JADHAV SHIVRAJ SHAHAJI	CIVIL ENGINEERING
286	BEA65	JAGDALE SAGAR	CIVIL ENGINEERING
287	BEA66	JAIWAR PRANSHU RAMLAL	CIVIL ENGINEERING
288	BEA67	JEURGI PRATIK CHANDRASHEKHAR	CIVIL ENGINEERING
289	BEA68	JOSHI SIDDHANT GANESH	CIVIL ENGINEERING
290	BEA69	KABURE GANNAN APPASO	CIVIL ENGINEERING

TRUE COPY



J.P.P.
 Vishwaniketan's (MEET)

291	BEA70	KACHARE VIVEK	CIVIL ENGINEING
292	BEA71	KAMBLE ANKUR RAJESH	CIVIL ENGINEING
293	BEA72	KAMBLE VIVEK SUNIL	CIVIL ENGINEING
294	BEA73	KARANJKAR AKASH RAJEBHAU	CIVIL ENGINEING
295	BEA74	KARDE SHUBHAM PRAKASH	CIVIL ENGINEING
296	BEA75	KATRODIA MITANSHU MANISH	CIVIL ENGINEING
297	BEA76	KHADAKBAN SUYOG VAIBHAV	CIVIL ENGINEING
298	BEA77	KHADE MAYURI DATTATRAY	CIVIL ENGINEING
299	BEA78	KHALOKAR SUSHANT AJAY	CIVIL ENGINEING
300	BEA79	KHANDALKAR ADITYA BALKRISHNA	CIVIL ENGINEING
301	BEA80	KHARATMOL SAGAR PANDURANG	CIVIL ENGINEING
302	BEA81	KHEDKAR AKSHAY ANAND	CIVIL ENGINEING
303	BEA82	KODAG AKASH GORAKH	CIVIL ENGINEING
304	BEA83	KOLAMBE TUSHAR BHAGWAN	CIVIL ENGINEING
305	BEA84	KOLEKAR AMOL JAGANNATH	CIVIL ENGINEING
306	BEA85	KOLEKAR PRATIK NAMDEO	CIVIL ENGINEING
307	BEA86	KOR GANESH SHANTARAM	CIVIL ENGINEING
308	BEA87	KOTIWALE AVISHKAR IRAPPA	CIVIL ENGINEING
309	BEA88	KUMAVAT KARAN ANAND	CIVIL ENGINEING
310	BEA89	KUMAVAT KIRAN DAGA	CIVIL ENGINEING
311	BEA90	KUNDALE SWAPNIL	CIVIL ENGINEING
312	BEA91	MADAKE ROSHANI SURESH	CIVIL ENGINEING
313	BEB01	MAHADIK ADITYA KASHINATH	CIVIL ENGINEING
314	BEB02	MAHALE KIRAN HARISH	CIVIL ENGINEING
315	BEB03	MAHANUR SURAJ	CIVIL ENGINEING
316	BEB04	MALKAR ROHIT GHANSHYAM	CIVIL ENGINEING
317	BEB05	MANDAVKAR MANSI SUDHAKAR	CIVIL ENGINEING
318	BEB06	MANE PRASAD VIKAS	CIVIL ENGINEING
319	BEB07	MASANE KAPIL	CIVIL ENGINEING
320	BEB08	MASKE VIKAS MUNJAJI	CIVIL ENGINEING
321	BEB09	MHATRE ADITYA R.	CIVIL ENGINEING
322	BEB10	MHATRE CHIRAYU JAHINDRANATH	CIVIL ENGINEING
323	BEB11	MHATRE NISHANT MANOHAR	CIVIL ENGINEING
324	BEB12	MHATRE NISHITA YASHVANT	CIVIL ENGINEING
325	BEB13	MHATRE PRANAV VILAS	CIVIL ENGINEING
326	BEB14	MHATRE PRATIKESH SHANKAR	CIVIL ENGINEING
327	BEB15	MHATRE RAHUL ASHOK	CIVIL ENGINEING

TRUE COPY



[Signature]
Principal
Vishwaniketan's (i MEET)

328	BEB16	MHATRE SAMIR	CIVIL ENGINEERING
329	BEB17	MHATRE SAURABH TUKARAM	CIVIL ENGINEERING
330	BEB18	MHATRE TEJAS HEMANT	CIVIL ENGINEERING
331	BEB19	MHATRE TEJASVI RAVINDRA	CIVIL ENGINEERING
332	BEB20	MOKAL MINAL JAYARAM	CIVIL ENGINEERING
333	BEB21	MOTE TEJAS CHANDRAKANT	CIVIL ENGINEERING
334	BEB22	MULEY PRANAY TEJRAO	CIVIL ENGINEERING
335	BEB23	MULLA SAJADA SHAFAHATAHAMAD	CIVIL ENGINEERING
336	BEB24	NAIK KETAN PADAJI	CIVIL ENGINEERING
337	BEB25	NANDGAONKAR RUTUJA SANTOSH	CIVIL ENGINEERING
338	BEB26	NARONA H. SHASHIKANT	CIVIL ENGINEERING
339	BEB27	NARVEKAR RUTIK ADIK	CIVIL ENGINEERING
340	BEB28	NIMBALKAR SUPRIYA GANPAT	CIVIL ENGINEERING
341	BEB29	NIVALE BALKRUSHNA LAXMAN	CIVIL ENGINEERING
342	BEB30	PACHARNE BHAVNA NANASAHEB	CIVIL ENGINEERING
343	BEB31	PADWAL SOHAN N	CIVIL ENGINEERING
344	BEB32	PAL SHUBHAM YASHWANT	CIVIL ENGINEERING
345	BEB33	PANDEY ARVIND RAMSAGAR	CIVIL ENGINEERING
346	BEB34	PANDEY NEERAJ RAMCHANDRA	CIVIL ENGINEERING
347	BEB35	PANDHARE AKSHAY	CIVIL ENGINEERING
348	BEB36	PARDESHI RUSHIKESH CHANDRAKANT	CIVIL ENGINEERING
349	BEB37	PAREKH RUSHABH MILAN	CIVIL ENGINEERING
350	BEB38	PATEL VEENA DHANJI	CIVIL ENGINEERING
351	BEB39	PATIL KAJAL DILIP	CIVIL ENGINEERING
352	BEB40	PATIL PRITIKA KIRIT	CIVIL ENGINEERING
353	BEB41	PATIL RAHUL SURESH	CIVIL ENGINEERING
354	BEB42	PATIL SANJANA SANDESH	CIVIL ENGINEERING
355	BEB43	PATIL AKASH GANESH	CIVIL ENGINEERING
356	BEB44	PATIL GITANJALI JAYAWANT	CIVIL ENGINEERING
357	BEB45	PATIL JAYESH MOHAN	CIVIL ENGINEERING
358	BEB46	PATIL KALYAN PRALHAD	CIVIL ENGINEERING
359	BEB47	PATIL OMKAR SARYAKANT	CIVIL ENGINEERING
360	BEB48	PATIL PARAMVIR PANDURANG	CIVIL ENGINEERING
361	BEB49	PATIL PAYAL KISHOR	CIVIL ENGINEERING
362	BEB50	PATIL PREETI SANTOSH	CIVIL ENGINEERING
363	BEB51	PATIL RONAK SANJIVAN	CIVIL ENGINEERING
364	BEB52	PATIL PURDYA ARUN	CIVIL ENGINEERING

TRUE COPY



(Signature)
Principal
Vishwan Ketan's (i MEET)

365	BEB53	PATIL SAHILU PARSHURAM	CIVIL ENGINEERING
366	BEB54	PATIL SAMIKSHA HANUMAN	CIVIL ENGINEERING
367	BEB55	PATIL TUSHAR VIJAY	CIVIL ENGINEERING
368	BEB56	PATIL VINAYA MADAN	CIVIL ENGINEERING
369	BEB57	PATRIKAR SHASHIWAT VINOD	CIVIL ENGINEERING
370	BEB58	PAWAR ASHUTOSH SHIVAJI	CIVIL ENGINEERING
371	BEB59	PAWAR CHAITANYA MILIND	CIVIL ENGINEERING
372	BEB60	PAWAR DHANANJAY DILIP	CIVIL ENGINEERING
373	BEB61	PAWAR OMKAR NARAYAN	CIVIL ENGINEERING
374	BEB62	PAWAR SANJAY SOMA	CIVIL ENGINEERING
375	BEB63	PUNYARTHI RUSHIKESH SADANAND	CIVIL ENGINEERING
376	BEB64	QUREISHI NOORUDDIN AHMED	CIVIL ENGINEERING
377	BEB65	SALAVI DARSHAN MANOHAR	CIVIL ENGINEERING
378	BEB66	SALEKAR LAUKIK BHARAT	CIVIL ENGINEERING
379	BEB67	SALUNKE ABHISHIEK GANESH	CIVIL ENGINEERING
380	BEB68	SAWANT VIJAY SUNIL	CIVIL ENGINEERING
381	BEB69	SAYYED HASAN AHMED	CIVIL ENGINEERING
382	BEB70	SHAIKH FAIYYAZ SAYYAD	CIVIL ENGINEERING
383	BEB71	SHAIKH IMAMUL JAKIR	CIVIL ENGINEERING
384	BEB72	SHAIKH SAAD ARSHAD	CIVIL ENGINEERING
385	BEB73	SHETYE RIDDHI ASHISH MANSI	CIVIL ENGINEERING
386	BEB74	SHINDE NIKHIL RAMESH	CIVIL ENGINEERING
387	BEB75	SHIRSAT ABHAY VITHOBA	CIVIL ENGINEERING
388	BEB76	SAUNDALKAR AKSHAY SAKHARAM	CIVIL ENGINEERING
389	BEB77	SOY ANAND NANDLAL	CIVIL ENGINEERING
390	BEB78	SURVE CHAITANYA SANJAY	CIVIL ENGINEERING
391	BEB79	TAMBADE GOPINATH RAJENDRA	CIVIL ENGINEERING
392	BEB80	TAMBOLI SUSHANT MADHUKAR	CIVIL ENGINEERING
393	BEB81	TEMBARE SIMRAN NANASAHEB	CIVIL ENGINEERING
394	BEB82	THAKUR SAHIL MANOHAR	CIVIL ENGINEERING
395	BEB83	THAKUR SURAJ BHARAT	CIVIL ENGINEERING
396	BEB84	THAKUR VAIBHAV VISHNU	CIVIL ENGINEERING
397	BEB85	VIRULKAR DHANSHRI ISHWAR	CIVIL ENGINEERING
398	BEB86	WAGH SAURABH MADHUKAR	CIVIL ENGINEERING
399	BEB87	WAGHMARE ANKITA ASHOK	CIVIL ENGINEERING
400	BEB88	WAGHULE KETAN BABASAHEB	CIVIL ENGINEERING
401	BEB89	WANALEKAR VARSHA HANUMANTRAO	CIVIL ENGINEERING

TRUE COPY

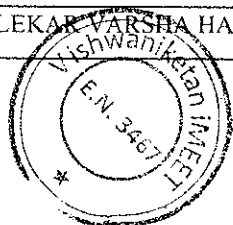

[Signature]
Principal

Vishwaniketan's (I MEET)

402	BEB90	WARKE SHIWETA SUDHAKAR	CIVIL ENGINEERING
403	BEB91	YADAV ANIKET MAHENDRA	CIVIL ENGINEERING
404	BEB92	YADAV NIRANJAN VITTHAL	CIVIL ENGINEERING
405	SCS01	BHALE PRASAD MILIND	COMPUTER ENGINEERING
406	SCS02	BHANDWALKAR PAYAL UTTAM	COMPUTER ENGINEERING
407	SCS03	BORKAR OM SANJAY	COMPUTER ENGINEERING
408	SCS04	CHANDAN AVINASH ANIL	COMPUTER ENGINEERING
409	SCS05	CHAUDHARI VIPUL ATMARAM	COMPUTER ENGINEERING
410	SCS06	DAREKAR CHAITALI DILIP	COMPUTER ENGINEERING
411	SCS07	DESHMUKH SIDDHIKA UMESH	COMPUTER ENGINEERING
412	SCS08	DHANAWADE SHREYASH MURLIDHAR	COMPUTER ENGINEERING
413	SCS09	GAURAV ANIL KHALAPURKAR	COMPUTER ENGINEERING
414	SCS10	GONDHALI PRACHI VAMAN	COMPUTER ENGINEERING
415	SCS11	GUPTA AAKASH MAHESH	COMPUTER ENGINEERING
416	SCS12	GUPTA AJITKUMAR RAMHAUSILA	COMPUTER ENGINEERING
417	SCS13	JANGALE BHAGWAN RAMBHAU	COMPUTER ENGINEERING
418	SCS14	JHA ASHISH ANIL KUMAR	COMPUTER ENGINEERING
419	SCS15	KADAVE PRATHAM RAMESH	COMPUTER ENGINEERING
420	SCS16	KAMBLE DEEPAK DATTATRAYA	COMPUTER ENGINEERING
421	SCS17	KENI YASH MANOJ	COMPUTER ENGINEERING
422	SCS18	KHANVILKAR PRATHAMESH MAHESH	COMPUTER ENGINEERING
423	SCS19	KOLI RAHUL LAXMAN	COMPUTER ENGINEERING
424	SCS20	KORGAONKAR SAKSHI SANTOSH	COMPUTER ENGINEERING
425	SCS21	KULKARNI PRIYA SANJAY	COMPUTER ENGINEERING
426	SCS22	LAHANE DEEP MANOHAR	COMPUTER ENGINEERING
427	SCS23	LAWAND SUMIT NANDKUMAR	COMPUTER ENGINEERING
428	SCS24	MAHULKAR RASIKA RAJENDRA	COMPUTER ENGINEERING
429	SCS25	MALEKAR NISHANT NISCHAL	COMPUTER ENGINEERING
430	SCS26	MISHRA UTKARSH	COMPUTER ENGINEERING
431	SCS27	MOKAL SNEHA RAJENDRA	COMPUTER ENGINEERING
432	SCS28	MULGIR ESHWAR SUBHASH	COMPUTER ENGINEERING
433	SCS29	NEGI RISHIKA KRISHNA	COMPUTER ENGINEERING
434	SCS30	NIKAM PARSHURAM SANJAY	COMPUTER ENGINEERING
435	SCS31	PANDEY NIMISH AJAYKUMAR	COMPUTER ENGINEERING
436	SCS32	PATIL SAKSHAM SACHIN	COMPUTER ENGINEERING
437	SCS33	PATIL SWARUPA HEMANT	COMPUTER ENGINEERING
438	SCS34	PATIL VEDASHREE MANOJKUMAR	COMPUTER ENGINEERING

TRUE COPY

[Signature]
Principal



Vishwaniketan's (I.M.E.T.)

439	SCS35	PAWAR DIGVIJAY RAJESH	COMPUTER ENGINEERING
440	SCS36	PAWAR SHYAM RANJEET	COMPUTER ENGINEERING
441	SCS37	PAWAR VEDANT HANMANT	COMPUTER ENGINEERING
442	SCS38	PEDNEKAR SANKET HARIRAM	COMPUTER ENGINEERING
443	SCS39	PEDNEKAR SHUBHAM SHAMRAO	COMPUTER ENGINEERING
444	SCS40	PURANIK ROHAN ANANT	COMPUTER ENGINEERING
445	SCS41	RANE NIKHIL	COMPUTER ENGINEERING
446	SCS42	REDDY ANNAPU CHENNA REDDY VENKATA REDD	COMPUTER ENGINEERING
447	SCS43	REEJHWANI RITIK BRIJLAL	COMPUTER ENGINEERING
448	SCS44	SADAKE PRATHMESH VIJAY	COMPUTER ENGINEERING
449	SCS45	SALGAR URMILA VIJAY	COMPUTER ENGINEERING
450	SCS46	SARGAR AMOL SHANKAR	COMPUTER ENGINEERING
451	SCS47	SAWANT PRATAP MADHUKAR	COMPUTER ENGINEERING
452	SCS48	SHANKAR ABHIJEET SUDHIR KUMAR	COMPUTER ENGINEERING
453	SCS49	SHETE ANAGHA	COMPUTER ENGINEERING
454	SCS50	SHINDE AMEY BHARAT	COMPUTER ENGINEERING
455	SCS51	SHINDE DIGVIJAY PRAVIN	COMPUTER ENGINEERING
456	SCS52	SHINDE RAHUL GAJENDRA	COMPUTER ENGINEERING
457	SCS53	SHIRKE VINAYAK DAYANAND	COMPUTER ENGINEERING
458	SCS54	SINGH ADITYA AJAY	COMPUTER ENGINEERING
459	SCS55	SINGH SAKSHI SUDHANSHU	COMPUTER ENGINEERING
460	SCS56	SINGH SANJIVANI VINOD	COMPUTER ENGINEERING
461	SCS57	SINGH SUKRITEE SANJAY	COMPUTER ENGINEERING
462	SCS58	SORTE CHIRAG JEEVAN	COMPUTER ENGINEERING
463	SCS59	TAKAWADE SIDDHI SHIVPRASAD	COMPUTER ENGINEERING
464	SCS60	TALEKAR SARTHAK VIJAY	COMPUTER ENGINEERING
465	SCS61	TANDALE SHREYA SANDEEP	COMPUTER ENGINEERING
466	SCS62	THALE RIDDHI RAMESH	COMPUTER ENGINEERING
467	SCS63	THOMBARE SAKSHI SANJAY	COMPUTER ENGINEERING
468	SCS64	TURKAR RAJ HARIPRASAD	COMPUTER ENGINEERING
469	SCS65	UPASE MEHUL BHOJRAJ	COMPUTER ENGINEERING
470	SCS66*	CHATALE AMRUTA BHAUSAHEB	COMPUTER ENGINEERING
471	SCS67*	CHIKHALKAR MANASI SANTOSH	COMPUTER ENGINEERING
472	SCS68*	DESHMUKH SHREYAS MOHAN	COMPUTER ENGINEERING
473	SCS69*	KUMBHAR SAURABH ARJUN	COMPUTER ENGINEERING
474	SCS70*	MULANI AMAAN SHARIF	COMPUTER ENGINEERING
475	SCS71*	PATIL JAYESH RAJENDRA	COMPUTER ENGINEERING

TRUE COPY

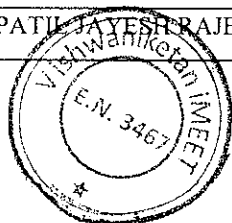

[Signature]
Principal
Vishwaniketan's (i MEET)

476	SCS72*	PATIL PRATIKSHA HANUMANT	COMPUTER ENGINEERING
477	SCS73*	PATIL SARVESH NANDKUMAR	COMPUTER ENGINEERING
478	SCS74*	PATIL TEJAS SUBHASH	COMPUTER ENGINEERING
479	SCS75*	QURESHI NIDA RAEES	COMPUTER ENGINEERING
480	SCS76*	TAWARE NIRANJAN UMESH	COMPUTER ENGINEERING
481	SCS77*	TELANG SAMBHAJI BHARAT	COMPUTER ENGINEERING
482	TE01	AMRALE PRATHMESH SANJAY	COMPUTER ENGINEERING
483	TE02	DALVI NIVEDITA YASHWANT	COMPUTER ENGINEERING
484	TE03	DESHMUKH PUNYAK MANOJ	COMPUTER ENGINEERING
485	TE04	DHANAWADE DHANASHREE HANAMANT	COMPUTER ENGINEERING
486	TE05	GAIKAR PRABODH NAMDEV	COMPUTER ENGINEERING
487	TE06	GAJRE ABHJEET AMRUT	COMPUTER ENGINEERING
488	TE07	JADHAV TANMAY SANJAY	COMPUTER ENGINEERING
489	TE08	KASLE VEDANT	COMPUTER ENGINEERING
490	TE09	KETKAR SHREYA CHANDRASHEKHAR	COMPUTER ENGINEERING
491	TE10	KHALADKAR OMKAR SUDHIR	COMPUTER ENGINEERING
492	TE11	KOLI ANUSHRI SUBHASH	COMPUTER ENGINEERING
493	TE12	KULKARNI KIRTI RAHUL	COMPUTER ENGINEERING
494	TE13	MANE RUTVIJ MAHENDRA	COMPUTER ENGINEERING
495	TE14	MANKAWLE DISHA RAJENDRA	COMPUTER ENGINEERING
496	TE15	MISHRA DHRUVKUMAR ANUSUYAPRASAD	COMPUTER ENGINEERING
497	TE16	MISHRA PRATIK AWADHESH	COMPUTER ENGINEERING
498	TE17	MOHITE DIVYANKA	COMPUTER ENGINEERING
499	TE18	MOKAL AKSHAYA NAMDEV	COMPUTER ENGINEERING
500	TE19	MULIK DIKSHA DILIP	COMPUTER ENGINEERING
501	TE20	NAIK PRAGATI GOPAL	COMPUTER ENGINEERING
502	TE21	NARAYANKAR CHAITANYA DUDAMBHAI	COMPUTER ENGINEERING
503	TE22	NARHARSHETTIWAR ATHARV ANIL	COMPUTER ENGINEERING
504	TE23	NARWADE SHYAMAL SANJAY	COMPUTER ENGINEERING
505	TE24	PATIL DHANASHREE DHANANJAY	COMPUTER ENGINEERING
506	TE25	PATIL MAHESH BALKRISHNA	COMPUTER ENGINEERING
507	TE26	PATIL MAMATA SANJAY	COMPUTER ENGINEERING
508	TE27	PATIL MRUNALI BABAN	COMPUTER ENGINEERING
509	TE28	PATIL RUTUJA SUJITKUMAR	COMPUTER ENGINEERING
510	TE29	PATIL SHRUTI KISHOR	COMPUTER ENGINEERING
511	TE30	PATIL SOURAV	COMPUTER ENGINEERING
512	TE31	PATIL SWARNIL MOHANDAS	COMPUTER ENGINEERING

TRUE COPY



[Signature]
Principal
Vishwaniketan's (i) MEET

513	TE32	PATIL TRUPTI PRAVIN	COMPUTER ENGINEERING
514	TE33	PINGALE ALANKAR ANIL	COMPUTER ENGINEERING
515	TE34	RAJADHYAKSHA PRASAD SHANTARAM	COMPUTER ENGINEERING
516	TE35	RAUT ANIKET	COMPUTER ENGINEERING
517	TE36	RAUT RUTURAJ SANJAY	COMPUTER ENGINEERING
518	TE37	SAWANT ASHUTOSH ARUN	COMPUTER ENGINEERING
519	TE38	SHINDE AVDHUT SHRIHARI	COMPUTER ENGINEERING
520	TE39	SINGH MUSKAN VIJAY	COMPUTER ENGINEERING
521	TE40	SINGH RITIKA PRADEEP	COMPUTER ENGINEERING
522	TE41	SINGH RITU NAGENDRA	COMPUTER ENGINEERING
523	TE42	TEMBHE HARSHAD RAMESH	COMPUTER ENGINEERING
524	TE43	VICHARE SHRUTI SUDHIR	COMPUTER ENGINEERING
525	TE44	VIDWANS AJINKYA DILEEP	COMPUTER ENGINEERING
526	TE45	WATEKAR KOMAL	COMPUTER ENGINEERING
527	TE46	WAVEKAR SUJAN SUNIL	COMPUTER ENGINEERING
528	TE47*	BHARMBE JAY ANIL	COMPUTER ENGINEERING
529	TE48*	CHAUDHARI AYUSH SUHAS	COMPUTER ENGINEERING
530	TE49*	CHOUHDARI SWAPNIL PURUSHOTTAM	COMPUTER ENGINEERING
531	TE50*	DHAYGUDE AKSHAY SUDAM	COMPUTER ENGINEERING
532	TE51*	DUBEY KAMAL	COMPUTER ENGINEERING
533	TE52*	GAONKAR ANIKETH NARAYAN	COMPUTER ENGINEERING
534	TE53*	GAWADE PIYUSH SHRIKANT	COMPUTER ENGINEERING
535	TE54*	HOLKAR HITESH SATISH	COMPUTER ENGINEERING
536	TE55*	JOSHI DHARMIK RAJESH	COMPUTER ENGINEERING
537	TE56*	KALEL OMKAR RAJARAM	COMPUTER ENGINEERING
538	TE57*	KATE ADITYA SUNIL	COMPUTER ENGINEERING
539	TE58*	KULKARNI PAVAN GOVINDRAO	COMPUTER ENGINEERING
540	TE59*	KULKARNI SUSHIL VIJAYKUMAR	COMPUTER ENGINEERING
541	TE60*	MANE OMKAR ARVIND	COMPUTER ENGINEERING
542	TE61*	MORE JATIN SUNIL	COMPUTER ENGINEERING
543	TE62*	NARENDRAGURU HARIKRISHNAN	COMPUTER ENGINEERING
544	TE63*	NIDHI PANKAJ SANTOSH	COMPUTER ENGINEERING
545	TE64*	PATIL SARVESH PRAVIN	COMPUTER ENGINEERING
546	TE65*	PINGALE KALYANI RAJENDRA	COMPUTER ENGINEERING
547	TE66*	SHARMA RITIK DEVIDAYAL	COMPUTER ENGINEERING
548	TE67*	SHERKHANE SNEHA	COMPUTER ENGINEERING
549	TE68*	SHIMPI SHIVANI AMOL	COMPUTER ENGINEERING

TRUE COPY



[Signature]
Principal
Vishwaniketan's (I MEET)

550	TE69*	SHRINAGARWAR VAIBHAV PRAVIN	COMPUTER ENGINEERING
551	TE70*	SINGH SRUJAN SANTOSH KUMAR	COMPUTER ENGINEERING
552	TE71*	TERDE JATIN YOGESH	COMPUTER ENGINEERING
553	TE72*	UCHIL SAMRUDH SUSHANT	COMPUTER ENGINEERING
554	BE1	ABHANG SHRUTI TANAJI	COMPUTER ENGINEERING
555	BE2	BHADANE GAURAV BHAYYASAHEB	COMPUTER ENGINEERING
556	BE3	BHAGAT SIDDHI RAMAKANT	COMPUTER ENGINEERING
557	BE4	BHALERAO PRATIK PANDURANG	COMPUTER ENGINEERING
558	BE5	BHOIR JAYESH RAMAKANT	COMPUTER ENGINEERING
559	BE6	BHOLE YASH VILAS	COMPUTER ENGINEERING
560	BE7	BHOSALE ANURAJ CHANDRAKANT	COMPUTER ENGINEERING
561	BE8	BURANGE POONAM GOVIND	COMPUTER ENGINEERING
562	BE9	DESHMUKH PRATIK DNYANESHWAR	COMPUTER ENGINEERING
563	BE10	DESHPANDE SUTEJ SUNIL	COMPUTER ENGINEERING
564	BE11	DHAKANE SACHIN SANJAY	COMPUTER ENGINEERING
565	BE12	DONGRE KRISHNAM AKSHAY	COMPUTER ENGINEERING
566	BE13	GAWADE SAMRUDDHI SANTOSH	COMPUTER ENGINEERING
567	BE14	GHADGE RACHANA JEEVAN	COMPUTER ENGINEERING
568	BE15	GURAV SAMIKSHA MAHESH	COMPUTER ENGINEERING
569	BE16	HEGDE SUDEEP DEEPAK	COMPUTER ENGINEERING
570	BE17	HINDLEKAR HRISHIKESH VIJAY	COMPUTER ENGINEERING
571	BE18	JAPE SUPRIYA BABAN	COMPUTER ENGINEERING
572	BE19	JOSHI VENKATESH ARUN	COMPUTER ENGINEERING
573	BE20	JUIKAR RIYA HEMANT	COMPUTER ENGINEERING
574	BE21	KADAM PRANALI DILIP	COMPUTER ENGINEERING
575	BE22	KALBHOR SUMIT SUBHASH	COMPUTER ENGINEERING
576	BE23	KANSE KIRAN MAHADEV	COMPUTER ENGINEERING
577	BE24	KAPSE AJINKYA CHANDRAKANT	COMPUTER ENGINEERING
578	BE25	KAWALE SWAGATA NITESH	COMPUTER ENGINEERING
579	BE26	KHOPADE SWARAJ SHRIDHAR	COMPUTER ENGINEERING
580	BE27	KOLPE HRISHIKESH JITENDRA	COMPUTER ENGINEERING
581	BE28	KUNTE HARSH DEEPAK	COMPUTER ENGINEERING
582	BE29	MAHTO DIYA DINESHKUMAR	COMPUTER ENGINEERING
583	BE30	MALKAR MANASI DINESH	COMPUTER ENGINEERING
584	BE31	MHATRE RASHMI UPENDRA	COMPUTER ENGINEERING
585	BE32	MHATRE UPASANA SHIVDAS	COMPUTER ENGINEERING
586	BE33	MISTRY POTH DEBIDAS	COMPUTER ENGINEERING

TRUE COPY

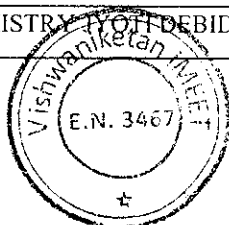

Vishwaniketan's (I MEET)

587	BE34	MOKAL KARISHMA GAJANAN	COMPUTER ENGINEERING
588	BE35	MOKAL VAISHNAVI PRABHAKAR	COMPUTER ENGINEERING
589	BE36	MOURYA ANKITA HIRA	COMPUTER ENGINEERING
590	BE37	NALAGE CHAITANYA GANPAT	COMPUTER ENGINEERING
591	BE38	NANDGAONKAR SHARVARI RAJENDRA	COMPUTER ENGINEERING
592	BE39	PARANGE SHUBHAM RAJENDRA	COMPUTER ENGINEERING
593	BE40	PATEL NARESH KANARAM	COMPUTER ENGINEERING
594	BE41	PATIL DHANASHREE SUBHASH	COMPUTER ENGINEERING
595	BE42	PATIL JAYESH HIRALAL	COMPUTER ENGINEERING
596	BE43	PATIL PURNIMA RAJENDRA	COMPUTER ENGINEERING
597	BE44	PATIL SIDDHESH SAMBHAJI	COMPUTER ENGINEERING
598	BE45	PATOLE NUTAN UTTAM	COMPUTER ENGINEERING
599	BE46	PAWAR MANSI JAYAWANT	COMPUTER ENGINEERING
600	BE47	PAWAR SONIKA SAMPAT	COMPUTER ENGINEERING
601	BE48	PRANJAL BHOSEKAR	COMPUTER ENGINEERING
602	BE49	RAUT NEHA ANIL	COMPUTER ENGINEERING
603	BE50	RAWATE AASHUTOSH KAILAS	COMPUTER ENGINEERING
604	BE51	RAY APRATIM ACHINTYA	COMPUTER ENGINEERING
605	BE52	SALVI AKSHAY NANDKUMAR	COMPUTER ENGINEERING
606	BE53	SAPANE AKSHAY PRAKASH	COMPUTER ENGINEERING
607	BE54	SASANE DAKSHATA SANJAY	COMPUTER ENGINEERING
608	BE55	SATHE SUCHITRA SURESH	COMPUTER ENGINEERING
609	BE56	SHAIKH RAHAT HAMID	COMPUTER ENGINEERING
610	BE57	SHELAR NAJUKA DINESH	COMPUTER ENGINEERING
611	BE58	SHELKE AJAY MANOHAR	COMPUTER ENGINEERING
612	BE59	SHUKLA VISHAL ANJANI	COMPUTER ENGINEERING
613	BE60	SINGH ROSHNI FIRNATH	COMPUTER ENGINEERING
614	BE61	SINGH SAMIKSHA PRATAP	COMPUTER ENGINEERING
615	BE62	SOMWANSHI ANIKET ASHOK	COMPUTER ENGINEERING
616	BE63	THALE SRUSHTI NAYAN	COMPUTER ENGINEERING
617	BE64	THALE VAISHNAVI DINESH	COMPUTER ENGINEERING
618	BE65	THORAT PRATIKSHA YASHWANT	COMPUTER ENGINEERING
619	BE66	THORAT PRATYUSH KAILAS	COMPUTER ENGINEERING
620	BE67	UGALE JANHAVI MADHUKAR	COMPUTER ENGINEERING
621	BE68	UPADHYAY TIRTH JAYESH	COMPUTER ENGINEERING
622	BE69	VELE DEVEN PRAMOD	COMPUTER ENGINEERING
623	BE70	VISHWAKARMA AJAY RAMHARSH	COMPUTER ENGINEERING

TRUE COPY



[Signature]
Vishwaniketan's (I.M.E.E.T)

624	BE71	WAKDE SHIRIN SUBHASH	COMPUTER ENGINEERING
625	BE72	ZALTE RAVINA VITTHAL	COMPUTER ENGINEERING
626	BE73	HUDGI GURURAJ MALLIKARJUN	COMPUTER ENGINEERING
627	BE74	JADHAV AKASH BALASAHEB	COMPUTER ENGINEERING
628	BE75	MISHRA NEHA DIGVIJAY	COMPUTER ENGINEERING
629	BE76	TELANGHE ADITYA PRAFULL	COMPUTER ENGINEERING
630	BE77	MOKAL VARUN VIKAS	COMPUTER ENGINEERING
631	BE78	SOLANKI AKSHAY MUKESH	COMPUTER ENGINEERING
632	BE79	TANDEL AATISH PRAKASHI	COMPUTER ENGINEERING
633	SE01	ADAGALE RUGVED MUGUTRAO USHA	ELECTRICAL ENGINEERING
634	SE02	BALKAWADE DEEP SANDEEP SHWETA	ELECTRICAL ENGINEERING
635	SE03	BANGAL JAGRUTI SANTOSH SIMANTINI	ELECTRICAL ENGINEERING
636	SE04	BHAGAT AJINKYA MOHAN MOHINI	ELECTRICAL ENGINEERING
637	SE05	BHOIR SANCHIT BHASKAR SANGITA	ELECTRICAL ENGINEERING
638	SE06	BHOSALE ABHISHEK HARISHCHANDRA MANDA	ELECTRICAL ENGINEERING
639	SE07	BHOSALE ANIRUDDHA PRATAP MANASI	ELECTRICAL ENGINEERING
640	SE08	BORRSE SIDHEISH DEEPAK SUVARNA	ELECTRICAL ENGINEERING
641	SE09	CHAULKAR ROHIT VILAS SHWETA	ELECTRICAL ENGINEERING
642	SE10	DALVI NAYAN NAGESH SUREKHA	ELECTRICAL ENGINEERING
643	SE11	GHODVINDE ROHAN SUNIL REKHA	ELECTRICAL ENGINEERING
644	SE12	GOPALE PRAVIN KISAN NUTAN	ELECTRICAL ENGINEERING
645	SE13	JADHAV ASHISH ANAND ASHA	ELECTRICAL ENGINEERING
646	SE14	JAMBEKAR KUNAL MADHUKAR MAMATA	ELECTRICAL ENGINEERING
647	SE15	KAMBLE ROHAN DEEPAK RESHMA	ELECTRICAL ENGINEERING
648	SE16	KENDE VAISHALI BHAU LILAM	ELECTRICAL ENGINEERING
649	SE17	KHAIRE ANIKET ARVIND ANKITA	ELECTRICAL ENGINEERING
650	SE18	KULKARNI MRUNMAYEE SANJAY VIJAYA	ELECTRICAL ENGINEERING
651	SE19	LOKHANDE RAJRATNA YASHAVANT VIJAYA	ELECTRICAL ENGINEERING
652	SE20	MALI ANURAG SANJIV ANITA	ELECTRICAL ENGINEERING
653	SE21	MANCHEKAR PRATIK CHANDRAKANT CHAITALI	ELECTRICAL ENGINEERING
654	SE22	MHATRE GEETA VISHWANATH VIJAYA	ELECTRICAL ENGINEERING
655	SE23	MHATRE KAUSTUBH JITENDRA VIJAYA	ELECTRICAL ENGINEERING
656	SE24	MHATRE PRAVIN VISHNU SARITA	ELECTRICAL ENGINEERING
657	SE25	MISHRA ADITYA ANUP ARCHANA	ELECTRICAL ENGINEERING
658	SE26	MOKAL MAYUR MOHAN MANISHA	ELECTRICAL ENGINEERING
659	SE27	NADKAR ROSHAN SANTOSH MANISHA	ELECTRICAL ENGINEERING
660	SE28	NAGAONKAR PRATIMAN MESH KISHOR KARUNA	ELECTRICAL ENGINEERING



TRUE COPY
 Vishwaniketan's (i MEET)

661	SE29	NIVATE ROSHAN GANGARAM GITANJALI	ELECTRICAL ENGINEERING
662	SE30	PATIL DIPESH HARIDAS REVATI	ELECTRICAL ENGINEERING
663	SE31	PATIL PRATIK SUNIL VARSHA	ELECTRICAL ENGINEERING
664	SE32	PATIL VISHAL PRABHAKAR SUJATA	ELECTRICAL ENGINEERING
665	SE33	PATIL YASH SUNIL SARIKA	ELECTRICAL ENGINEERING
666	SE34	PAWAR VIVEK VITTHAL BHARATI	ELECTRICAL ENGINEERING
667	SE35	PINGALE RAHUL RAMESH KALPANA	ELECTRICAL ENGINEERING
668	SE36	RAUT ADITYA VISHWAS ASHA	ELECTRICAL ENGINEERING
669	SE37	RAUT VAIBHAV TANAJI LATA	ELECTRICAL ENGINEERING
670	SE38	SAJEKAR TEJAS ANIL ANITA	ELECTRICAL ENGINEERING
671	SE39	SHAIKH SUFIYA MUNAF NAEEMA	ELECTRICAL ENGINEERING
672	SE40	SHINDE SHREYAS RAJESH RASHMI	ELECTRICAL ENGINEERING
673	SE41	SINGH DIVYAM SANJAY RITU	ELECTRICAL ENGINEERING
674	SE42	SINGH SACHINKUMAR AKHILESHPRASAD	ELECTRICAL ENGINEERING
675	SE43	SINGH SARANI ARVIND RENU	ELECTRICAL ENGINEERING
676	SE44	THAKARE PRATHAMESH DINESH LATA	ELECTRICAL ENGINEERING
677	SE45	THAKARE PREM GANESH MANISHA	ELECTRICAL ENGINEERING
678	SE46	THAKUR ADITYA AJIT ARATI	ELECTRICAL ENGINEERING
679	SE47	WAGHMARE MAYURI BIBHISHAN CHHABABAI	ELECTRICAL ENGINEERING
680	SE48	YADAV SURAJ ARUN SONAM	ELECTRICAL ENGINEERING
681	SE49	YEDE PAWAN PANDIT SAVITA	ELECTRICAL ENGINEERING
682	SE50	ZORE SANDIP SAYAJI BANABAI	ELECTRICAL ENGINEERING
683	TE01	AMBAVANE GAURAV GANESH	ELECTRICAL ENGINEERING
684	TE02	BANDRE ANIKET ANIL	ELECTRICAL ENGINEERING
685	TE03	BARVE ANIKET ANIL	ELECTRICAL ENGINEERING
686	TE04	BHONKAR SUBHAV VILAS	ELECTRICAL ENGINEERING
687	TE05	BHOSALE PRATHMESH SURYKANT	ELECTRICAL ENGINEERING
688	TE06	BURUMKAR AMOL HARISHCHANDRA	ELECTRICAL ENGINEERING
689	TE07	CHAUDHARI VARAD JAYESH	ELECTRICAL ENGINEERING
690	TE08	CHAUDHARI NAYAN KACHARU	ELECTRICAL ENGINEERING
691	TE09	DAS ANINDYA TAPAN	ELECTRICAL ENGINEERING
692	TE10	DESHMUKH SAURAV BABAN	ELECTRICAL ENGINEERING
693	TE11	DEWARDE SHRUTIKA ANAND	ELECTRICAL ENGINEERING
694	TE12	GADAMALE RONIT DASHARATH	ELECTRICAL ENGINEERING
695	TE13	GADGE PRESHIT PRAKASH	ELECTRICAL ENGINEERING
696	TE14	GAIKAR JAY	ELECTRICAL ENGINEERING
697	TE15	GAIKWAD OMKAR BALKRISHNA	ELECTRICAL ENGINEERING

TRUE COPY



Pr. Pr.
Vishwaniketan's (i) MEET

698	TE16	GAIKWAD SAURABH	ELECTRICAL ENGINEERING
699	TE17	GUPTA RAVIKUMAR SURENDRANATH	ELECTRICAL ENGINEERING
700	TE18	GUPTA RAKESH UTTAM	ELECTRICAL ENGINEERING
701	TE19	KAMBLE SUMEDH BHASKAR	ELECTRICAL ENGINEERING
702	TE20	KANTIKAR PRATIK PANDURANG	ELECTRICAL ENGINEERING
703	TE21	KARALE NAYAN ARVIND	ELECTRICAL ENGINEERING
704	TE22	KATHAVALE GURUNATH DEEPAK	ELECTRICAL ENGINEERING
705	TE23	KHAIR ROHAN RAJENDRA	ELECTRICAL ENGINEERING
706	TE24	KHANDEKAR TANMAY DNYANESHWAR	ELECTRICAL ENGINEERING
707	TE25	KHISMATRAO PRASAD	ELECTRICAL ENGINEERING
708	TE26	KHOPKAR SONALI AVINASH	ELECTRICAL ENGINEERING
709	TE27	KOLI DIVYESH CHANDRAKANT	ELECTRICAL ENGINEERING
710	TE28	KOTWADKAR RAKIB MOHSIN	ELECTRICAL ENGINEERING
711	TE29	LIMAYE MIHIR	ELECTRICAL ENGINEERING
712	TE30	MHATRE PRASAD SANDIP	ELECTRICAL ENGINEERING
713	TE31	MHATRE SNEHA GANESH	ELECTRICAL ENGINEERING
714	TE32	MHATRE PRATHAMESH PRAFULLA	ELECTRICAL ENGINEERING
715	TE33	MORE ABHAY BALASAHEB	ELECTRICAL ENGINEERING
716	TE34	MUNE AKASH DASHRATH	ELECTRICAL ENGINEERING
717	TE35	NADKAR SHWETA ANANT	ELECTRICAL ENGINEERING
718	TE36	NALAVADE SURAJ SUNIL	ELECTRICAL ENGINEERING
719	TE37	NARE KIRAN BHALCHANDRA	ELECTRICAL ENGINEERING
720	TE38	NIMBALE SANDESH SHANKAR	ELECTRICAL ENGINEERING
721	TE39	PADELKAR AMIT SHANKAR	ELECTRICAL ENGINEERING
722	TE40	PARDESHI PRITAM	ELECTRICAL ENGINEERING
723	TE41	PATIL NIKHIL BALIRAM	ELECTRICAL ENGINEERING
724	TE42	PATIL ANKITA NANDKUMAR	ELECTRICAL ENGINEERING
725	TE43	PATIL MANJUL VINOD	ELECTRICAL ENGINEERING
726	TE44	PATIL PAVAN JANARDAN	ELECTRICAL ENGINEERING
727	TE45	PATIL PRATHAMESH NANDAKUMAR	ELECTRICAL ENGINEERING
728	TE46	PATIL ROHAN MARUTI	ELECTRICAL ENGINEERING
729	TE47	PATIL SHUBHAM KIRAN	ELECTRICAL ENGINEERING
730	TE48	PATIL VISHAL VASUDEV	ELECTRICAL ENGINEERING
731	TE49	PATIL BHAGYESH	ELECTRICAL ENGINEERING
732	TE50	PAWAR AISHWARYA PRADEEP	ELECTRICAL ENGINEERING
733	TE51	PHIRANGE VISHAL BHAU	ELECTRICAL ENGINEERING
734	TE52	PIMPALKAR DIPKA NANDKUMAR	ELECTRICAL ENGINEERING

TRUE COPY



JKP
President
Vishwaniketan's (i) MEET

735	TE53	RATHOD ADARSH ARVIND	ELECTRICAL ENGINEERING
736	TE54	SAKAT AJAY KUNDLIK	ELECTRICAL ENGINEERING
737	TE55	SALPE ABHISHI K ANANT	ELECTRICAL ENGINEERING
738	TE56	SALUNKE SOHAM SAMEER	ELECTRICAL ENGINEERING
739	TE57	SANAS HARSHAD MADHUKAR	ELECTRICAL ENGINEERING
740	TE58	SATVE VAISHNAV BALU	ELECTRICAL ENGINEERING
741	TE59	SHAIKH AADIL SHAHID	ELECTRICAL ENGINEERING
742	TE60	SHENDAGE SANKET ANANDA	ELECTRICAL ENGINEERING
743	TE61	SHINDE KALPESH PARSHURAM	ELECTRICAL ENGINEERING
744	TE62	SHINDE KAUSHAL RUPESH	ELECTRICAL ENGINEERING
745	TE63	SHINGARE ADITYA SHRIKANT	ELECTRICAL ENGINEERING
746	TE64	SHIRKE ANIKET HARISHCHANDRA	ELECTRICAL ENGINEERING
747	TE65	SONAR RUSHIKESH ANIL	ELECTRICAL ENGINEERING
748	TE66	UPADHAYA SUNIL SHAMBHU	ELECTRICAL ENGINEERING
749	TE67	VEDPATHAK OMKAR KIRTIKUMAR	ELECTRICAL ENGINEERING
750	TE68	WAGH UMESH BABAN	ELECTRICAL ENGINEERING
751	TE69	YADAV AKSHAY ANIL	ELECTRICAL ENGINEERING
752	TE70	YAMDAGNI PRITHVIRAJ	ELECTRICAL ENGINEERING
753	TE71	NAGARKAR NAMRATA	ELECTRICAL ENGINEERING
754	TE72	MANER ALPESH	ELECTRICAL ENGINEERING
755	TE73	WADE SANKET	ELECTRICAL ENGINEERING
756	BE01	BANGAR AKASH ARJUN	ELECTRICAL ENGINEERING
757	BE02	BENDRE ANIKET PRATAP	ELECTRICAL ENGINEERING
758	BE03	BHAGAT ANUSHKA VINOD	ELECTRICAL ENGINEERING
759	BE04	BHOIR NARAYAN PUNDLIK	ELECTRICAL ENGINEERING
760	BE05	CHAKRABORTY NISHANT	ELECTRICAL ENGINEERING
761	BE06	CHAVAN OMKAR LAXMAN	ELECTRICAL ENGINEERING
762	BE07	CHOUDHARI SAYALI SUNIL	ELECTRICAL ENGINEERING
763	BE08	DAHIMBEKAR TEJAL ANIL	ELECTRICAL ENGINEERING
764	BE09	DALE ROHAN RAJESH	ELECTRICAL ENGINEERING
765	BE10	DALVI SAYALI RAMESH	ELECTRICAL ENGINEERING
766	BE11	DAREKAR AVINASH SUBHASH	ELECTRICAL ENGINEERING
767	BE12	DESHMUKH TUSHAR VIJAY	ELECTRICAL ENGINEERING
768	BE13	DHAPATE SWAPNIL CHANDRASEN	ELECTRICAL ENGINEERING
769	BE14	DHURI YOGITA KAMALAKAR	ELECTRICAL ENGINEERING
770	BE15	DUBE RASHIKA VILAS	ELECTRICAL ENGINEERING
771	BE16	GAIKWAD VIJAY SHIVAJI	ELECTRICAL ENGINEERING

TRUE COPY



Principals
Vishwanandan's (I) MEET

772	BE17	GHANVAT AMIT MARUTI	ELECTRICAL ENGINEERING
773	BE18	GHARAT VINAYA SANDESH	ELECTRICAL ENGINEERING
774	BE19	GHORPADE ABHIJEET SAMBHAJI	ELECTRICAL ENGINEERING
775	BE20	GHUME SHREENIVAS BALAJI	ELECTRICAL ENGINEERING
776	BE21	GOYAL PRUTHVI SHIVRAM	ELECTRICAL ENGINEERING
777	BE22	HUKE SUPRAJ SUBODH	ELECTRICAL ENGINEERING
778	BE23	JADHAV MAYUR MANOJ	ELECTRICAL ENGINEERING
779	BE24	JADHAV OMKAR MARUTI	ELECTRICAL ENGINEERING
780	BE25	JADHAV SURAJ SUNIL	ELECTRICAL ENGINEERING
781	BE26	JOSHI SHRUTI SUDHIR	ELECTRICAL ENGINEERING
782	BE27	KARDE YUVRAJ BHALCHANDRA	ELECTRICAL ENGINEERING
783	BE28	KASARE SAGAR DILIP	ELECTRICAL ENGINEERING
784	BE29	LADGE ANUJA DHANANJAY	ELECTRICAL ENGINEERING
785	BE30	LANDGE SHRADDHA BHASKAR	ELECTRICAL ENGINEERING
786	BE31	MADAN PALLAVI BABURAO	ELECTRICAL ENGINEERING
787	BE32	MAHATO KRISHNA SANAT	ELECTRICAL ENGINEERING
788	BE33	MALI HARSHALI PRABHAKAR	ELECTRICAL ENGINEERING
789	BE34	MHATRE DIKSHA MAHADEV	ELECTRICAL ENGINEERING
790	BE35	MHATRE SIDDHESH DEVIDAS	ELECTRICAL ENGINEERING
791	BE36	MISHRA KARUNANAND MANOJ	ELECTRICAL ENGINEERING
792	BE37	MOKAL NISHANT KRISHNA	ELECTRICAL ENGINEERING
793	BE38	NARAYANKAR, RISHABH. BHASKAR	ELECTRICAL ENGINEERING
794	BE39	NHAVKAR NIRANJAN NAMDEV	ELECTRICAL ENGINEERING
795	BE40	OVHAL PRATIK PRABHAKAR	ELECTRICAL ENGINEERING
796	BE41	PADALKAR PRATIK PANDURANG	ELECTRICAL ENGINEERING
797	BE42	PANDIT SHREELESH	ELECTRICAL ENGINEERING
798	BE43	PARTHE VAIBHAV VIJAY	ELECTRICAL ENGINEERING
799	BE44	PATHARE DARSHAN SURESH	ELECTRICAL ENGINEERING
800	BE45	PATIL AJAY DILIP	ELECTRICAL ENGINEERING
801	BE46	PATIL ASMIT KAILAS	ELECTRICAL ENGINEERING
802	BE47	PATIL HARSHAL SADANAND	ELECTRICAL ENGINEERING
803	BE48	PATIL JAYESH SANJAY	ELECTRICAL ENGINEERING
804	BE49	PATIL MAHENDRA CHHOTULAL	ELECTRICAL ENGINEERING
805	BE50	PATIL NAYAN GOPINATH	ELECTRICAL ENGINEERING
806	BE51	PATIL NIHAR SANJAY	ELECTRICAL ENGINEERING
807	BE52	PATIL SAHIL SOPAN	ELECTRICAL ENGINEERING
808	BE53	PATIL SHRADDHA RAMESH	ELECTRICAL ENGINEERING

TRUE COPY

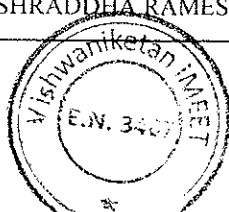

[Signature]
Principal
Vishwaniketan's (I) MEET

809	BE54	PATIL SHUBHAM HARIBHAU	ELECTRICAL ENGINEERING
810	BE55	PATIL SIDDHESH KESARINATH	ELECTRICAL ENGINEERING
811	BE56	PATIL VISHANT DEVIDAS	ELECTRICAL ENGINEERING
812	BE57	PAWAR NITESH	ELECTRICAL ENGINEERING
813	BE58	PHADKE AMEYA ANAND	ELECTRICAL ENGINEERING
814	BE59	SABLE OMKAR PRAVIN	ELECTRICAL ENGINEERING
815	BE60	SALUNKHE SURAJ SUBHASH	ELECTRICAL ENGINEERING
816	BE61	SALUNKHE TEJAS HANUMANT	ELECTRICAL ENGINEERING
817	BE62	SHELKE RAVIKANU	ELECTRICAL ENGINEERING
818	BE63	SHIRKE KALPESH ANKUSH	ELECTRICAL ENGINEERING
819	BE64	SUTAR NIKHIL KISHOR	ELECTRICAL ENGINEERING
820	BE65	SUTAR SHUBHAM SHASHIKANT	ELECTRICAL ENGINEERING
821	BE66	TANDEL PANKAJ DHANAJI	ELECTRICAL ENGINEERING
822	BE67	TARU AMEY RAVINDRA	ELECTRICAL ENGINEERING
823	BE68	THAKUR AKHIL VIDYADHAR	ELECTRICAL ENGINEERING
824	BE69	THAKUR BHAVANA DHANAJI	ELECTRICAL ENGINEERING
825	BE70	THAKUR RAHUL RAMESH	ELECTRICAL ENGINEERING
826	BE71	THALE SHREYAS SHRIKANT	ELECTRICAL ENGINEERING
827	BE72	THALE TEJAL VIKAS	ELECTRICAL ENGINEERING
828	BE73	TODANKAR VIPRESH DIGAMBAR	ELECTRICAL ENGINEERING
829	BE74	TORASKAR TEJASHRI DASHARATH	ELECTRICAL ENGINEERING
830	BE75	TUPE BHAGYASHREE KASHINATH	ELECTRICAL ENGINEERING
831	BE76	UBHARE SHREYA SANJAY	ELECTRICAL ENGINEERING
832	BE77	VAGHARE SWAGAT MANOHAR	ELECTRICAL ENGINEERING
833	BE78	VARTAK AKASH KISHOR	ELECTRICAL ENGINEERING
834	BE79	WADAL PARAS DATTATREY	ELECTRICAL ENGINEERING
835	BE80	WASAVE SURAJ BHIMA	ELECTRICAL ENGINEERING
836	SE 01	ATOLEY ATHARVA MAHENDRA	NICS AND TELECOMMUNICATION ENGI
837	SE 02	AWADE MRUNAL PARAG	NICS AND TELECOMMUNICATION ENGI
838	SE 03	BANGAD NAYANKUMAR NILESHKUMAR	NICS AND TELECOMMUNICATION ENGI
839	SE 04	CHATURVEDI BHUMIKA	NICS AND TELECOMMUNICATION ENGI
840	SE 05	CHERKAR PRANAV DINKAR	NICS AND TELECOMMUNICATION ENGI
841	SE 06	CHHAPEKAR NOORINA NOORMOHAMMAD	NICS AND TELECOMMUNICATION ENGI
842	SE 07	DESHMUKH NIRANJAN SANJIV	NICS AND TELECOMMUNICATION ENGI
843	SE 08	GAWADE VAISHNAVI MOHAN	NICS AND TELECOMMUNICATION ENGI
844	SE 09	GULAVANI YASH YOGESH	NICS AND TELECOMMUNICATION ENGI
845	SE 10	INAMDAR SANIKA ATUL	NICS AND TELECOMMUNICATION ENGI



TRUE COPY
 Principal
 Vishwaniketan's (I) MEET

846	SE 11	JAGTAP RITU KONIBA	NICS AND TELECOMMUNICATION ENGI
847	SE 12	KALAMDANE MANSI RAJENDRA	NICS AND TELECOMMUNICATION ENGI
848	SE 13	KHETRI NIDHI RAJESH	NICS AND TELECOMMUNICATION ENGI
849	SE 14	KOLI ONKAR ARUN	NICS AND TELECOMMUNICATION ENGI
850	SE 15	KULKARNI SHUBHANKAR VIJAYKUMAR	NICS AND TELECOMMUNICATION ENGI
851	SE 16	MHATRE SIDDHESH BHALCHANDRA	NICS AND TELECOMMUNICATION ENGI
852	SE 17	MHATRE SUYOG SURESH	NICS AND TELECOMMUNICATION ENGI
853	SE 18	NANDGAONKAR JAYESH NARENDRA	NICS AND TELECOMMUNICATION ENGI
854	SE 19	PANDHARE PRATHMESH RAJKUMAR	NICS AND TELECOMMUNICATION ENGI
855	SE 20	PATIL SATISH GANESH	NICS AND TELECOMMUNICATION ENGI
856	SE 21	DESHMUKH JAGRUTI SURESH	NICS AND TELECOMMUNICATION ENGI
857	SE 22	GHARAT NIKITA BHARAT	NICS AND TELECOMMUNICATION ENGI
858	SE 23	NEMLEKAR RAGHUNATH MANGESH	NICS AND TELECOMMUNICATION ENGI
859	SE 24	THALE SAURABH MAHENDRA	NICS AND TELECOMMUNICATION ENGI
860	TE 01	ABDUL FARHAN ABDUL KARIM SAMAN	NICS AND TELECOMMUNICATION ENGI
861	TE 02	BAGAYATKAR YASH ABHAS	NICS AND TELECOMMUNICATION ENGI
862	TE 03	BHOIR ISHIKA RAVINDRA	NICS AND TELECOMMUNICATION ENGI
863	TE 04	DABIR SAKSHI PADMAKAR	NICS AND TELECOMMUNICATION ENGI
864	TE 05	DESHIPANDE APURVA VIDYDHAR	NICS AND TELECOMMUNICATION ENGI
865	TE 06	DESHIPANDE PRATHAMA VIDYADHAR	NICS AND TELECOMMUNICATION ENGI
866	TE 07	DHANAWADE PRATHAMESH JITENDRA	NICS AND TELECOMMUNICATION ENGI
867	TE 08	GHARAT MRUNAL SANDEEP	NICS AND TELECOMMUNICATION ENGI
868	TE 09	GHARAT PRAJAKTA DATTATRAY	NICS AND TELECOMMUNICATION ENGI
869	TE 10	GODSE VEDANT SHRIKANT	NICS AND TELECOMMUNICATION ENGI
870	TE 11	JOSHI NIKHIL JANARDAN	NICS AND TELECOMMUNICATION ENGI
871	TE 12	JOSHI SUJALDEV SUNIL	NICS AND TELECOMMUNICATION ENGI
872	TE 13	KAZI ZAYAN SHABBIR SHAINAZ	NICS AND TELECOMMUNICATION ENGI
873	TE 14	KOKANE RUSHIKESH BHANUDAS	NICS AND TELECOMMUNICATION ENGI
874	TE 15	KOLI ASHISH MANOJ	NICS AND TELECOMMUNICATION ENGI
875	TE 16	KUSHWAHA AKHILESH GOPAL	NICS AND TELECOMMUNICATION ENGI
876	TE 17	MANE MRUGANAYANI VINOD	NICS AND TELECOMMUNICATION ENGI
877	TE 18	MHATRE SWATI SUNIL	NICS AND TELECOMMUNICATION ENGI
878	TE 19	MOHITE KOMAL MANDAR	NICS AND TELECOMMUNICATION ENGI
879	TE 20	PANDE RAVIKUMAR DAYANAND	NICS AND TELECOMMUNICATION ENGI
880	TE 21	PANDITPAUTRA VRIKSH KALPESH	NICS AND TELECOMMUNICATION ENGI
881	TE 22	PATIL AKANKSHA HEMANT	NICS AND TELECOMMUNICATION ENGI
882	TE 23	PATIL NILESH MANOJ	NICS AND TELECOMMUNICATION ENGI

TRUE COPY



[Signature]
Principal
Vishwaniketan's (i MEET)

883	TE 24	PATIL OM RAJENDRA	NICS AND TELECOMMUNICATION ENGI
884	TE 25	PATIL PIYUSH BALIRAM	NICS AND TELECOMMUNICATION ENGI
885	TE 26	PATIL VISHAL RAJENDRA	NICS AND TELECOMMUNICATION ENGI
886	TE 27	PHADTARE ABHISHEK HANUMANT	NICS AND TELECOMMUNICATION ENGI
887	TE 28	RANE MANISH DATTARAM	NICS AND TELECOMMUNICATION ENGI
888	TE 29	SHAJOL V.SHAJI JOLLYMMA	NICS AND TELECOMMUNICATION ENGI
889	TE 30	SHARMA RICHA GIANESHWAR	NICS AND TELECOMMUNICATION ENGI
890	TE 31	SHINDE ASHWINI DEEPAK	NICS AND TELECOMMUNICATION ENGI
891	TE 32	SHINDE VISHWAJEET DATTATRAY	NICS AND TELECOMMUNICATION ENGI
892	TE 33	SONAWALE SAURABH SUBHASH	NICS AND TELECOMMUNICATION ENGI
893	TE 34	VAREKAR MAYURI BHAGAVATRAO	NICS AND TELECOMMUNICATION ENGI
894	TE 35	VERMA SHASHANK RAMESHANKAR	NICS AND TELECOMMUNICATION ENGI
895	TE 36	WADKAR VINAY ANIL	NICS AND TELECOMMUNICATION ENGI
896	TE 37	WAGH RUSHABH SANJAY	NICS AND TELECOMMUNICATION ENGI
897	TE 38	YAGNIK RIDDHI MUKUNDBHAI	NICS AND TELECOMMUNICATION ENGI
898	BE 01	ASHISH AHIRE NITIN	NICS AND TELECOMMUNICATION ENGI
899	BE 02	BHALERAO SHUBHAM SANJAY	NICS AND TELECOMMUNICATION ENGI
900	BE 03	BHOPI MAYURESH MOHAN	NICS AND TELECOMMUNICATION ENGI
901	BE 04	BHOSALE DHANASHREE MANOHAR	NICS AND TELECOMMUNICATION ENGI
902	BE 05	BHOSALE KIRAN SANJEEV	NICS AND TELECOMMUNICATION ENGI
903	BE 06	DAKSH MAAN KUSHALPAL	NICS AND TELECOMMUNICATION ENGI
904	BE 07	DASWADKAR MILIND JANARDAN	NICS AND TELECOMMUNICATION ENGI
905	BE 08	DESHMUKH RUTUJA KISHOR	NICS AND TELECOMMUNICATION ENGI
906	BE 09	DESHMUKH SHWETA SUNIL	NICS AND TELECOMMUNICATION ENGI
907	BE 10	KADAM OMKAR ARVIND	NICS AND TELECOMMUNICATION ENGI
908	BE 11	KUMBHAR KUNAL SHASHIKANT	NICS AND TELECOMMUNICATION ENGI
909	BE 12	LOTE MANSI VINAYAK	NICS AND TELECOMMUNICATION ENGI
910	BE 13	MANE PRATIKSHA AJIT	NICS AND TELECOMMUNICATION ENGI
911	BE 14	MHATRE RUPALI SHAILESH	NICS AND TELECOMMUNICATION ENGI
912	BE 15	MOKAL SWAGAT ANIL	NICS AND TELECOMMUNICATION ENGI
913	BE 16	MORE NIHAR SANDEEP	NICS AND TELECOMMUNICATION ENGI
914	BE 17	MORE PRATIKSHA DILIP	NICS AND TELECOMMUNICATION ENGI
915	BE 18	NEMADE GAURAV SANTOSH	NICS AND TELECOMMUNICATION ENGI
916	BE 19	PANDIT SANDESH PRAKASH	NICS AND TELECOMMUNICATION ENGI
917	BE 20	PATIL JAYDIP PRAKASH	NICS AND TELECOMMUNICATION ENGI
918	BE 21	PATIL NIKITA BABASAHEB	NICS AND TELECOMMUNICATION ENGI
919	BE 22	PATIL VINAYAK	NICS AND TELECOMMUNICATION ENGI



TRUE COPY

[Signature]

Principal
Vishwaniketan's (i MEET)

920	BE 23	PAWAR SANKET BAPU	NICS AND TELECOMMUNICATION ENGI
921	BE 24	PINGALE KEDAR SUNIL	NICS AND TELECOMMUNICATION ENGI
922	BE 25	SHAHANE SAKSHI ATUL	NICS AND TELECOMMUNICATION ENGI
923	BE 26	SONAWALE AJINKYA SUBHASHI	NICS AND TELECOMMUNICATION ENGI
924	BE 27	SUTAR SHARVARI KISHOR	NICS AND TELECOMMUNICATION ENGI
925	BE 28	THAKARE TEJASVI GANESH	NICS AND TELECOMMUNICATION ENGI
926	BE 29	THOMBARE SHRADDHA GAJENDRA	NICS AND TELECOMMUNICATION ENGI
927	SEA01	BHAGAT SOHAN UMESH	MECHANICAL ENGINEERING
928	SEA02	BHESARE SHRIYOG SANTOSH	MECHANICAL ENGINEERING
929	SEA03	CHATARE TEJAS HEMANTKUMAR	MECHANICAL ENGINEERING
930	SEA04	CHILE PRAJAKTA HARISHCHANDRA	MECHANICAL ENGINEERING
931	SEA05	DATAR ADITYA UDAY	MECHANICAL ENGINEERING
932	SEA06	GAVAND SHUBHAM JAGDISH	MECHANICAL ENGINEERING
933	SEA07	GHADGE ROHAN JAGANNATHI	MECHANICAL ENGINEERING
934	SEA08	GHARAT CHAITANYA VINOD	MECHANICAL ENGINEERING
935	SEA09	KAMBLE SMITA SANTOSH	MECHANICAL ENGINEERING
936	SEA10	KHAN MOHAMMAD SHAYAN MOHAMMAD SUHEL	MECHANICAL ENGINEERING
937	SEA11	KHAN TAUFIQUE RAFIQUE	MECHANICAL ENGINEERING
938	SEA12	MALI VIVEK ARUN	MECHANICAL ENGINEERING
939	SEA13	MHATRE PRATHAMESH ARUN	MECHANICAL ENGINEERING
940	SEA14	NIKAM PRASAD BHAU	MECHANICAL ENGINEERING
941	SEA15	PATIL AMEY RAJENDRA	MECHANICAL ENGINEERING
942	SEA16	PHANSE SARANGKUMAR RAVINDRA	MECHANICAL ENGINEERING
943	SEA17	PRASAD SHARADKUMAR YOGENDRA	MECHANICAL ENGINEERING
944	SEA19	SHELAR DIPANSHU DINESH	MECHANICAL ENGINEERING
945	SEA20	VELASKAR SURAJ SUNIL	MECHANICAL ENGINEERING
946	SEA21	CHALKE JEEVAN DEEPAK	MECHANICAL ENGINEERING
947	SEA22	MOKAL OMITYA PRASAD	MECHANICAL ENGINEERING
948	SEA23	PATIL DIPESH BHAGWAN	MECHANICAL ENGINEERING
949	SEA24	PATIL SAIRAJ PANKAJ	MECHANICAL ENGINEERING
950	SEA25	PATIL SHUBHAM RAMESH	MECHANICAL ENGINEERING
951	SEA26	PATIL VEDANT ANIL	MECHANICAL ENGINEERING
952	SEA27	TANDEL MAKARAND MAHESH	MECHANICAL ENGINEERING
953	SEA28	DHANORKAR SHREY RAVINDRA	MECHANICAL ENGINEERING
954	SEA29	DAWARE SHREYAS BHAUSAHEB	MECHANICAL ENGINEERING
955	SEA32	PRATAPURE AJINKYA	MECHANICAL ENGINEERING
956	SEA33	KAKADE SACHIN GORAKSHA	MECHANICAL ENGINEERING

TRUE COPY



Prin...
Vishwaniketan's (I MEET)

957	SEA34	DESHMUKH YASH SANTOSH	MECHANICAL ENGINEERING
958	SE A36	FARNANDES WILSON MICHEAL	MECHANICAL ENGINEERING
959	SEA39	DALVI RHUTIK	MECHANICAL ENGINEERING
960	DSE40	BHATKAR SAHIL ASHISH	MECHANICAL ENGINEERING
961	DSE41	CHAVAN SHREYAS DEEPAK	MECHANICAL ENGINEERING
962	DSE42	CHORGE YASH RAJESH	MECHANICAL ENGINEERING
963	DSE43	DEGAONKAR ANIKET ARVIND	MECHANICAL ENGINEERING
964	DSE44	DESHMUKH OMKAR PRALHAD	MECHANICAL ENGINEERING
965	DSE45	GADE SANKET RAMESH	MECHANICAL ENGINEERING
966	DSE46	GAIKWAD OMKAR DATTATRAY	MECHANICAL ENGINEERING
967	DSE47	KAMBLE PRATHAMESH SUNIL	MECHANICAL ENGINEERING
968	DSE48	KHOPADE OMKAR SHEKHAR	MECHANICAL ENGINEERING
969	DSE49	KUMBHAR RUTURAJ BAJARANG	MECHANICAL ENGINEERING
970	DSE50	MAHADIK SAKSHI BHARAT	MECHANICAL ENGINEERING
971	DSE51	MHATRE DEVESH DASHARATH	MECHANICAL ENGINEERING
972	DSE52	MHATRE PRANAY PRABHAKAR	MECHANICAL ENGINEERING
973	DSE53	MHATRE PRITAM SHAMKANT	MECHANICAL ENGINEERING
974	DSE54	MHATRE SUSHMITA DAYANAND	MECHANICAL ENGINEERING
975	DSE55	MHATRE SWAGAT SHASHIKANT	MECHANICAL ENGINEERING
976	DSE56	MORE ROHIT RAMESH	MECHANICAL ENGINEERING
977	DSE57	NALE AKASH DADASAHEB	MECHANICAL ENGINEERING
978	DSE58	PANDAV RAHUL RAJENDRA	MECHANICAL ENGINEERING
979	DSE59	PARBALKAR ASNIL BALIRAM	MECHANICAL ENGINEERING
980	DSE60	PATIL OMKAR PRADIP	MECHANICAL ENGINEERING
981	DSE61	PATIL SHREYAS SHASHIKANT	MECHANICAL ENGINEERING
982	DSE62	PATIL SHUBHAM SURESH	MECHANICAL ENGINEERING
983	DSE63	PAWAR CHINMAY UDDHAV	MECHANICAL ENGINEERING
984	DSE64	PIRAKAR SHAILESH RAMCHANDRA	MECHANICAL ENGINEERING
985	DSE65	SAKPAL RUTIK MADHUKAR	MECHANICAL ENGINEERING
986	DSE66	SASANE AMIT RAJU	MECHANICAL ENGINEERING
987	DSE67	THITE MIHIR SANTOSH	MECHANICAL ENGINEERING
988	DSE68	WAGHULKAR YASH SANTOSH	MECHANICAL ENGINEERING
989	DSE69	WAVEKAR PRATHAMESH MAHESH	MECHANICAL ENGINEERING
990	DSE70	ZALTE AKSHAY RAJU	MECHANICAL ENGINEERING
991	DSE71	ZANZANE RAJ VIKAS	MECHANICAL ENGINEERING
992	TEA01	ASHTPUTRE SARTHAK SANDEEP	MECHANICAL ENGINEERING
993	TEA02	BABBE VIKASH GANESH SANGEETA	MECHANICAL ENGINEERING

TRUE COPY



[Signature]
 Vishwanathan's (I MEET)

994	TEA03	BADGUJAR NACHIKET YUVRAJ SANGEETA	MECHANICAL ENGINEERING
995	TEA04	BARDAY TABISH ISHAQUE HEENA	MECHANICAL ENGINEERING
996	TEA05	BHAGAT MOHIT SANTOSH SAMIKSHA	MECHANICAL ENGINEERING
997	TEA06	BHAT RAMKRISHNA KISHORE DEEPA	MECHANICAL ENGINEERING
998	TEA07	BHOIR MUKESH DASHRATH NARMADA	MECHANICAL ENGINEERING
999	TEA08	BISWAL ASHIRWAD RADHAMOHAN MANASIRAN	MECHANICAL ENGINEERING
1000	TEA09	BORKAR ANUJ HANUMANT REKHA	MECHANICAL ENGINEERING
1001	TEA10	CHAVAN OMKAR TATOO TANUJA	MECHANICAL ENGINEERING
1002	TEA11	CHORAGHE MANOJ MARUTI AASHA	MECHANICAL ENGINEERING
1003	TEA12	CHOURASIYA VISHAL PRIYAVRAT PUSPA	MECHANICAL ENGINEERING
1004	TEA13	DESHMUKH SHUBHAM RAJENDRA URMILA	MECHANICAL ENGINEERING
1005	TEA14	GHARAT RAJ GHARAT JANARDAN SUNITA	MECHANICAL ENGINEERING
1006	TEA15	GHOSALKAR JIGNESH ANIL SUVARNA	MECHANICAL ENGINEERING
1007	TEA16	GODBOLE MANAS YOGESH NISHA	MECHANICAL ENGINEERING
1008	TEA17	GUPTA ASHU SANJAY GUNJAN	MECHANICAL ENGINEERING
1009	TEA18	JADHAV DIPESH DILIP SUREKHA	MECHANICAL ENGINEERING
1010	TEA19	JADHAV PRATHAMESH SANTOSH KALPANA	MECHANICAL ENGINEERING
1011	TEA20	JAGTAP PUNIT JAYAVANT KADAMBARI	MECHANICAL ENGINEERING
1012	TEA21	JOSHI SUYOG NITIN SANGITA	MECHANICAL ENGINEERING
1013	TEA22	KARADE MANOJ NANA SAVITA	MECHANICAL ENGINEERING
1014	TEA23	KARJIKAR ARFAZ MOHAMMAD HANIF NASEEMA	MECHANICAL ENGINEERING
1015	TEA24	KHAIR ROSHAN RAJENDRA SHARADA	MECHANICAL ENGINEERING
1016	TEA25	KHAN ADNAN SOFIYAN AKHTARI	MECHANICAL ENGINEERING
1017	TEA26	KHARCHE KETAN LAXMAN APARNA	MECHANICAL ENGINEERING
1018	TEA27	KHEDEKAR TEJAS SACHIN NISHA	MECHANICAL ENGINEERING
1019	TEA28	KUMBHAR SHIVKUMAR BHARAT SHANKRAMMA	MECHANICAL ENGINEERING
1020	TEA29	KUSHWAHA ABHISHEK RAMBADAN GYANTY	MECHANICAL ENGINEERING
1021	TEA30	MAHADIK SWAPNIL SHANTARAM SHITAL	MECHANICAL ENGINEERING
1022	TEA31	MANDHARE PRANAY DATTATRAY CHHAYA	MECHANICAL ENGINEERING
1023	TEA32	MHASE ROSHAN GANESH SUREKHA	MECHANICAL ENGINEERING
1024	TEA33	MHATRE VEDANT RAJENDRA SANGITA	MECHANICAL ENGINEERING
1025	TEA34	MODAK GAURAV CHANDRAKANT CHAITALI	MECHANICAL ENGINEERING
1026	TEA35	MORE KARAN HARISHCHANDRA MANDA	MECHANICAL ENGINEERING
1027	TEA36	MUSALE SANKET SUNIL SEEMA	MECHANICAL ENGINEERING
1028	TEA37	NAGOTKAR AKSHAY ANIL ASHWINI	MECHANICAL ENGINEERING
1029	TEA38	NANGARE YOGESH KUNDALIK CHHAYA	MECHANICAL ENGINEERING
1030	TEA39	NEMAN SIDDHARTH HEMU HEMANTI	MECHANICAL ENGINEERING

TRUE COPY



[Signature]
Vishwaniketan's (I) MGET

1031	TEA40	PANCHAL KUNAL PRADEEP APARNA	MECHANICAL ENGINEERING
1032	TEA41	PANDEY MAYANK	MECHANICAL ENGINEERING
1033	TEA42	PAPAL KARAN MAHADEO SHOBHA	MECHANICAL ENGINEERING
1034	TEA43	PATHAK SHREYAS SHRINIVAS ANAHGA	MECHANICAL ENGINEERING
1035	TEA44	PATIL ASHISH SAMADHAN KUNDA	MECHANICAL ENGINEERING
1036	TEA45	PATIL PRANAY GANESH UJJAWALA	MECHANICAL ENGINEERING
1037	TEA46	PATIL ROHIT CHANDRAKANT ALAKA	MECHANICAL ENGINEERING
1038	TEA47	PATIL SAHIL VIVEK SWATI	MECHANICAL ENGINEERING
1039	TEA48	PATIL SUBODH SHIVAJI	MECHANICAL ENGINEERING
1040	TEA49	PATIL SURAJ SHASHIKANT SHUBHANGI	MECHANICAL ENGINEERING
1041	TEA50	PATIL TEJASVI SHARAD ASHA	MECHANICAL ENGINEERING
1042	TEA51	PAWAR HRISHIKESH SANDIPAN NEETA	MECHANICAL ENGINEERING
1043	TEA52	PAWAR SAURABH SUNIL SUJATA	MECHANICAL ENGINEERING
1044	TEA53	PINGALE MANISH SHYAM NEERA	MECHANICAL ENGINEERING
1045	TEA54	POLEKAR MEGHRAJ DNYANESHWAR SAVITA	MECHANICAL ENGINEERING
1046	TEA55	RATAMBE TEJAS MANOHAR MADHAVI	MECHANICAL ENGINEERING
1047	TEA56	RAVALE KETAN GOPAL POONAM	MECHANICAL ENGINEERING
1048	TEA57	RUPANWAR PRATIK HANUMANT BHAGYASHREE	MECHANICAL ENGINEERING
1049	TEA58	SACHAN SARANSH YOGENDRA RENU	MECHANICAL ENGINEERING
1050	TEA59	SALEKAR RAJ MANOHAR SUSHMA	MECHANICAL ENGINEERING
1051	TEA60	SAWANT DEVARSH VIVEK SMITA	MECHANICAL ENGINEERING
1052	TEA61	SHAIKH MOHAMMEDFARHAN FAIYAZAHMAD FA	MECHANICAL ENGINEERING
1053	TEA62	SHARMA JEETENDRA ROHITASH HEMLATA	MECHANICAL ENGINEERING
1054	TEA63	SHARMA MANISH SUNIL SANGEETA	MECHANICAL ENGINEERING
1055	TEA64	SHARMA ROSHAN BARVN NEELAM	MECHANICAL ENGINEERING
1056	TEA65	SHINDE AKASH BHIMSEN JAYASHREE	MECHANICAL ENGINEERING
1057	TEA66	SHINDE VIPUL SHRIMANT RUPALI	MECHANICAL ENGINEERING
1058	TEA67	SINGH HEMANT AKHILESH SINGH BEENA SINGH	MECHANICAL ENGINEERING
1059	TEA68	SINGH NIRAJ DHARMENDRA POONAM	MECHANICAL ENGINEERING
1060	TEA69	SINGH SUMITKUMAR SUNILKUMAR MANJU	MECHANICAL ENGINEERING
1061	TEA70	SOMANE OMKAR PRADEEP PRAMILA	MECHANICAL ENGINEERING
1062	TEA71	SONAWANE JAYESH NARESH JYOTI	MECHANICAL ENGINEERING
1063	TEA72	SURYAVANSHI PRATIK DINKAR SEEMA	MECHANICAL ENGINEERING
1064	TEA73	TARAVADE VEDANT MOHAN VAISHALI	MECHANICAL ENGINEERING
1065	TEA74	TELAGE DHIRAJ GIRISH MINAKSHI	MECHANICAL ENGINEERING
1066	TEA75	THAKUR DHIRANJALI PRAKASH MAHANADA	MECHANICAL ENGINEERING
1067	TEA76	THAKUR DHIRANJALI PRAKASH MAHANADA	MECHANICAL ENGINEERING

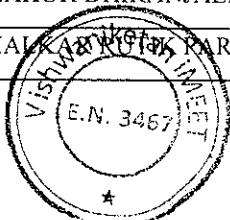

TRUE COPY

[Handwritten Signature]

1068	TEA77	THOMBARE SHUBHAM PRADEEP NEETA	MECHANICAL ENGINEERING
1069	TEA78	THOSAR SHUBHAM RAVIKANT KALPANA	MECHANICAL ENGINEERING
1070	TEA79	VARANSHE SHUBHAM RAJENDRA USHA	MECHANICAL ENGINEERING
1071	TEA80	WAVEKAR SIDDHANT SURESH ALAKA	MECHANICAL ENGINEERING
1072	TEB01	AJILWAD RUSHIKESH PRAKASH LATA	MECHANICAL ENGINEERING
1073	TEB02	BHAVKE SHUBHAM SHANKAR	MECHANICAL ENGINEERING
1074	TEB03	BHAVSAR HRUSHIKESH MILIND MANISHA	MECHANICAL ENGINEERING
1075	TEB04	BHOSALE KOMAL ANIL GEETA	MECHANICAL ENGINEERING
1076	TEB05	BISWAS JAYKUMAR KARTICK ALPANARANI	MECHANICAL ENGINEERING
1077	TEB06	CHOGALE PRATHAMESH PANDURANG PRAVITA	MECHANICAL ENGINEERING
1078	TEB07	CHOGALE VINIT SUDAM AASHA	MECHANICAL ENGINEERING
1079	TEB08	CHOGLA HANZALA ARIF SAMEENA	MECHANICAL ENGINEERING
1080	TEB09	DALVI YADNESH DNYANESHWAR DEEPTI	MECHANICAL ENGINEERING
1081	TEB10	DIVEKAR PRAMOD TUKARAM MEENA	MECHANICAL ENGINEERING
1082	TEB11	DOKHALE JIVAN DHARMA ROHINI	MECHANICAL ENGINEERING
1083	TEB12	DUKHANDE YASH MILIND SHUBHANGI	MECHANICAL ENGINEERING
1084	TEB13	GAIKAWAD PRATHAMESH BAPURAO VANDANA	MECHANICAL ENGINEERING
1085	TEB14	GAIKWAD SACHIN MARUTI HAUSA	MECHANICAL ENGINEERING
1086	TEB15	GAIKWAD SAHIL DINESH RAJASHREE	MECHANICAL ENGINEERING
1087	TEB16	GHOHARE TEJAS ANIL	MECHANICAL ENGINEERING
1088	TEB17	KAMBLE NIKHIL VIKAS SAVITA	MECHANICAL ENGINEERING
1089	TEB18	KATE JAY VIJAY VISHAKHA	MECHANICAL ENGINEERING
1090	TEB19	KATKE SHIVAM ASHOK ANUSAYA	MECHANICAL ENGINEERING
1091	TEB20	KHULAM SUSHILKUMAR JAYAVANT SUPRIYA	MECHANICAL ENGINEERING
1092	TEB21	KOLI SHIVAM RAJENDRA SUNITA	MECHANICAL ENGINEERING
1093	TEB22	LOTE MAHESH UMESH INDU	MECHANICAL ENGINEERING
1094	TEB23	LOTE MAYUR NANDKUMAR BABY	MECHANICAL ENGINEERING
1095	TEB24	MAGAR ABHISHEK NANDKUMAR HARSHDA	MECHANICAL ENGINEERING
1096	TEB25	MANVE SUNIL BABAN SUVARNA	MECHANICAL ENGINEERING
1097	TEB26	MHATRE SUYOG KISHOR SUREKHA	MECHANICAL ENGINEERING
1098	TEB27	MISHRA ROSHAN SANJEEV BABLI	MECHANICAL ENGINEERING
1099	TEB28	NIMASE VIGNESH BHAGWAN SANTOSHI	MECHANICAL ENGINEERING
1100	TEB29	PARTHE DINESH SANTOSH MEENA	MECHANICAL ENGINEERING
1101	TEB30	PATIL ABHIYASH MANOJ CHANDRAKALA	MECHANICAL ENGINEERING
1102	TEB31	PATIL AKASH CHANDRAKANT SHUBHANGI	MECHANICAL ENGINEERING
1103	TEB32	PATIL AMIT TULSHINATH	MECHANICAL ENGINEERING
1104	TEB33	PATIL ASHISH PRAVIN PRANITA	MECHANICAL ENGINEERING

TRUE COPY



[Signature]
Vishwaniketan's (i) MEET

1105	TEB34	PATIL HARSH TUKARAM SANJAYA	MECHANICAL ENGINEERING
1106	TEB35	PATIL NISHANT BALKRISHNA SARITA	MECHANICAL ENGINEERING
1107	TEB36	PATIL RAJ RAMESH ASHA	MECHANICAL ENGINEERING
1108	TEB37	PATOLE SACHIN PRAKASH SUREKHA	MECHANICAL ENGINEERING
1109	TEB38	PAWAR VED GAJANAN NAYANA	MECHANICAL ENGINEERING
1110	TEB39	PINGALE PRITESH SHANMUKH SIMA	MECHANICAL ENGINEERING
1111	TEB40	PRABHU TUSHAR RAVINDRA SHOBIANA	MECHANICAL ENGINEERING
1112	TEB41	RAUT SOHAM AMOL SAVITA	MECHANICAL ENGINEERING
1113	TEB42	RUBDE SHAILESH ANIL SHUBHANGI	MECHANICAL ENGINEERING
1114	TEB43	SADHU GHANSHYAM VITHOBA VANDANA	MECHANICAL ENGINEERING
1115	TEB44	SALUNKE ASHISH ASHOK ASHWINI	MECHANICAL ENGINEERING
1116	TEB45	SHAH HARDIK PRADEEP SADHANA	MECHANICAL ENGINEERING
1117	TEB46	SHINDE AKASH DIGAMBAR SANDHYA	MECHANICAL ENGINEERING
1118	TEB47	SHINGRUT SANMESH SANJAY SUPRIYA	MECHANICAL ENGINEERING
1119	TEB48	SINGH DEEPAK DINESH SAROJ	MECHANICAL ENGINEERING
1120	TEB49	SONAWANE SWAPNIL SAVKAR NUTAN	MECHANICAL ENGINEERING
1121	TEB50	SURVE SARVESH RAMESH RESHMA	MECHANICAL ENGINEERING
1122	TEB51	TAMBE PRATIK PRABHAKAR PRANITA	MECHANICAL ENGINEERING
1123	TEB52	THAKUR SWAPNIL SANTOSH SAPNA	MECHANICAL ENGINEERING
1124	TEB53	VIDWANS MANAS CHINTAMANI RAJSHREE	MECHANICAL ENGINEERING
1125	TEB54	VIHAL MANDEEPSINGH GURMEETSINGH SUKVIN	MECHANICAL ENGINEERING
1126	TEB55	VISHWAKARMA ANUJ LALJI REETA DEVI	MECHANICAL ENGINEERING
1127	TEB56	WAGHMARE DNYANESHVAR DATTA GIRAJA	MECHANICAL ENGINEERING
1128	TEB57	YERUNKAR SAHIL VIJAY VINATI	MECHANICAL ENGINEERING
1129	TEB58	GOLHAR VIKAS ASHOK SANGITA	MECHANICAL ENGINEERING
1130	TEB59	GHARAT JAY ANANT ASHWINI	MECHANICAL ENGINEERING
1131	TEB60	DOMBALE SANJEEVANI LALASAHEB NEELAM	MECHANICAL ENGINEERING
1132	TEB61	MALI VIRAJ RAJENDRA VIDYA	MECHANICAL ENGINEERING
1133	TEB62	PATIL AKSHAY NAMADEO RATNAPRABHA	MECHANICAL ENGINEERING
1134	TEB63	SINGH RAGHVENDRA ARUN INDU	MECHANICAL ENGINEERING
1135	TEB64	MHATRE SNEHAL MADHUKAR SUVARNA	MECHANICAL ENGINEERING
1136	TEB65	GUTTE KRISHNA	MECHANICAL ENGINEERING
1137	TEB66	LOKHANDE SANKET	MECHANICAL ENGINEERING
1138	TEB67	SUPE LOKESH RAJENDRA YOGITA	MECHANICAL ENGINEERING
1139	TEB68	JAWALE RISHIKESH BHARAT KUNDA	MECHANICAL ENGINEERING
1140	TEB69	VASHIKAR RUSHABH RAJESH RHUJULA	MECHANICAL ENGINEERING
1141	TEB70	BHAGAT TANUJ DINESH VIDYA	MECHANICAL ENGINEERING

TRUE COPY



[Signature]
Principal
Vishwaniketan's (i) MEET

1142	TEB71	MAGAR OMKAR ROHIDAS SADHANA	MECHANICAL ENGINEERING
1143	TEB72	MHATRE KARAN MANOJ ARCHANA	MECHANICAL ENGINEERING
1144	TEB73	RAWOOL AKSHAY ANAND ARCHANA	MECHANICAL ENGINEERING
1145	TEB74	PITKAR AJIT VIVEK ARCHANA	MECHANICAL ENGINEERING
1146	TEB75	PATHL VINIT ANIL VINAYAKI	MECHANICAL ENGINEERING
1147	TEB76	SINGH ABHISHEK KUNWAR SAROJ	MECHANICAL ENGINEERING
1148	TEB77	SINGH AAKASH DEVENDRA BEENA	MECHANICAL ENGINEERING
1149	TEB78	SOLKAR MOHAMMADSAROSH KABIL MARIYA	MECHANICAL ENGINEERING
1150	BE-A-01	ANDHALE ANIKET Sampat SARALA	MECHANICAL ENGINEERING
1151	BE-A-02	ARKE SAGAR BHAUSAHEB REKHA	MECHANICAL ENGINEERING
1152	BE-A-03	ATKARI TEJAS SANJAY ARCHANA	MECHANICAL ENGINEERING
1153	BE-A-04	BAGUL HARSHAL EKNATH SEEMA	MECHANICAL ENGINEERING
1154	BE-A-05	BANGAR VIKAS ARJUN SAUBAI	MECHANICAL ENGINEERING
1155	BE-A-06	BARUA ABHISHEK RANJIT JAYITA	MECHANICAL ENGINEERING
1156	BE-A-07	BARVE AKASH SATYVAN ASHWINI	MECHANICAL ENGINEERING
1157	BE-A-08	BHAGAT AKSHAY ANANDKUMAR PRAMILA	MECHANICAL ENGINEERING
1158	BE-A-09	BHAWKE OMKAR BAJARANG SHUBHANGI	MECHANICAL ENGINEERING
1159	BE-A-10	BHAYTANDEL ANIKET CHANDRAKANT KAVITA	MECHANICAL ENGINEERING
1160	BE-A-11	BHOIR ROHAN HEMANT PRATIBHA	MECHANICAL ENGINEERING
1161	BE-A-12	BHOSALE OMKAR SHANKAR SANDHYA	MECHANICAL ENGINEERING
1162	BE-A-13	BHUSARI APURV VISHNU ALKA	MECHANICAL ENGINEERING
1163	BE-A-14	CHANDEL SATEJSINGH MAHENDRASINGH	MECHANICAL ENGINEERING
1164	BE-A-15	CHANDORKAR SOHAM ATUL SUCHITRA	MECHANICAL ENGINEERING
1165	BE-A-16	CHAUDHARY HIMANSHU PRALHAD SHEETAL	MECHANICAL ENGINEERING
1166	BE-A-17	CHAVAN VISHWAJIT SATISH VRUSHALI	MECHANICAL ENGINEERING
1167	BE-A-18	CHOUDHARY SURAJ KEDAR PRASAD SUDHAKUM	MECHANICAL ENGINEERING
1168	BE-A-19	DALVI KUNAL RAVINDRA VAISHALI	MECHANICAL ENGINEERING
1169	BE-A-20	DALVI MAYURESH SUNIL MADHURI	MECHANICAL ENGINEERING
1170	BE-A-21	DESHMUKH NIKHIL UDAY	MECHANICAL ENGINEERING
1171	BE-A-22	DESHMUKH SAHIL DINESH DIPIKA	MECHANICAL ENGINEERING
1172	BE-A-23	DESHMUKH SANKET SURESH NIRMALA	MECHANICAL ENGINEERING
1173	BE-A-24	DHARANE DIPESH ASHOK ASHWINI	MECHANICAL ENGINEERING
1174	BE-A-25	DHUMAL AKASH ARVIND SAVITA	MECHANICAL ENGINEERING
1175	BE-A-26	DUDHBHATE SURAJ KHANDU KAMAL	MECHANICAL ENGINEERING
1176	BE-A-27	FAKKE AKASH RAJENDRA RUCHITRA	MECHANICAL ENGINEERING
1177	BE-A-28	GAIKWAD JAY PRAFULL REKHA	MECHANICAL ENGINEERING
1178	BE-A-29	GAIKWAD MRUNAL NARENDRA	MECHANICAL ENGINEERING

TRUE COPY



[Signature]

Principal

Vishwaniketan's (I.M.E.E.T)

1179	BE-A-30	GAJRE ABHISHEK ANRUT SUNITA	MECHANICAL ENGINEERING
1180	BE-A-31	GATARE SHARDUL SHEKHAR MINAL	MECHANICAL ENGINEERING
1181	BE-A-32	GAVADE OMKAR SANTOSH RUPALI	MECHANICAL ENGINEERING
1182	BE-A-33	GHADAGE UTKARSH MADHUKAR SUSHAMA	MECHANICAL ENGINEERING
1183	BE-A-34	GHARAT AARTI VISHWANATH ARCHANA	MECHANICAL ENGINEERING
1184	BE-A-35	GHARAT ABHIJIT RAMCHANDRA	MECHANICAL ENGINEERING
1185	BE-A-36	GHARAT DIPTESH CHANDRAKANT VAISHALI	MECHANICAL ENGINEERING
1186	BE-A-37	GHARAT PUSHPAK RAJESH SUNITA	MECHANICAL ENGINEERING
1187	BE-A-38	GHARAT SARVESH SHIVDAS JAYASHREE	MECHANICAL ENGINEERING
1188	BE-A-39	GHOLE DAKSHET SURESH SUCHITA	MECHANICAL ENGINEERING
1189	BE-A-40	GHOSALKAR PARESH PRAKASH PRATIKSHA	MECHANICAL ENGINEERING
1190	BE-A-41	HEGISTE BHUSHAN SHRIKANT SHRADDHA	MECHANICAL ENGINEERING
1191	BE-A-42	INGALE ONKAR LAXMAN	MECHANICAL ENGINEERING
1192	BE-A-43	JADHAV GAURAV CHHOTULAL MANJUSHA	MECHANICAL ENGINEERING
1193	BE-A-44	JADHAV ROHIT BAPUSO	MECHANICAL ENGINEERING
1194	BE-A-45	JAIN SHUBHAM PARASMAL	MECHANICAL ENGINEERING
1195	BE-A-46	JOSHI RUTIK PRABHAKAR PRATIKSHA	MECHANICAL ENGINEERING
1196	BE-A-47	KADU YASH JITENDRA POOJA	MECHANICAL ENGINEERING
1197	BE-A-48	KAMBALE SIDDHANT SANJAY SUREKHA	MECHANICAL ENGINEERING
1198	BE-A-49	KAMBLE ANIKET BALU BHARATI	MECHANICAL ENGINEERING
1199	BE-A-50	KAMBLE SUMEDHI BALIRAM KALPANA	MECHANICAL ENGINEERING
1200	BE-A-51	KANU RESHMA NANDKISHOR	MECHANICAL ENGINEERING
1201	BE-A-52	KARKARE ANKIT RAMESH SMITA	MECHANICAL ENGINEERING
1202	BE-A-53	KATE MOHAN DNYANDEV PUSHPA	MECHANICAL ENGINEERING
1203	BE-A-54	KATKE KUNAL NANDKUMAR KARUNA	MECHANICAL ENGINEERING
1204	BE-A-55	KHANDALE RAVINDRA BIRAPPA	MECHANICAL ENGINEERING
1205	BE-A-56	KHANDEKAR TUSHAR RAJARAM Sampada	MECHANICAL ENGINEERING
1206	BE-A-57	KHEDEKAR SHUBHAM RAOSAHEB ANITA	MECHANICAL ENGINEERING
1207	BE-A-58	KOKANE OMKAR SOMESHWAR JYOTI	MECHANICAL ENGINEERING
1208	BE-A-59	KULKARNI SHREERANG PRAMOD SANJEEVANI	MECHANICAL ENGINEERING
1209	BE-A-60	KURMI VAIBHAV SHAMBHU USHA	MECHANICAL ENGINEERING
1210	BE-A-61	LAGDHIR MAYUR RAMJI HIRIBEN	MECHANICAL ENGINEERING
1211	BE-A-62	LANGI SAMIKSHA YOGESH UJWALA	MECHANICAL ENGINEERING
1212	BE-A-63	LENDAVE SUYASH SIDDHESHWAR SANGEETA	MECHANICAL ENGINEERING
1213	BE-A-64	MADHAVI SARVESH SANTOSH HEMLATA	MECHANICAL ENGINEERING
1214	BE-A-65	MALI NIRAJ JIJABRAO PARUL	MECHANICAL ENGINEERING
1215	BE-A-66	MALISARIL SHARAD RANJANA	MECHANICAL ENGINEERING

TRUE COPY

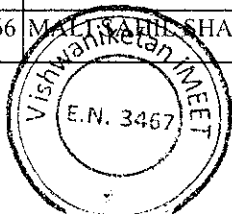

[Signature]
Principal
Vishwaniketan's (I MEET)

1216	BE-A-67	MANE NIKHIL SURESH MANISHA	MECHANICAL ENGINEERING
1217	BE-A-68	MHATRE KUNAL BALIRAM ROHINI	MECHANICAL ENGINEERING
1218	BE-A-69	MHATRE KUNAL SHASHIKANT	MECHANICAL ENGINEERING
1219	BE-A-70	MHATRE MRUNAL KRISHNA RAJESHRI	MECHANICAL ENGINEERING
1220	BE-A-71	MHATRE NITESH MUKUND GEETA	MECHANICAL ENGINEERING
1221	BE-A-72	MHATRE PRATIK JANARDAN POONAM	MECHANICAL ENGINEERING
1222	BE-A-73	MOKAL AMIT VILAS SUJATA	MECHANICAL ENGINEERING
1223	BE-A-74	MOKAL NANDAN ANIL SUNANDA	MECHANICAL ENGINEERING
1224	BE-A-75	MOKAL SAHIL KAMALAKAR RANJANA	MECHANICAL ENGINEERING
1225	BE-A-76	MORE AJINKYA AMOL SONALI	MECHANICAL ENGINEERING
1226	BE-A-77	MORE SONAL HARIBHAU NIRMALA	MECHANICAL ENGINEERING
1227	BE-A-78	NADKAR SHUBHAM RAMESH ROSHNI	MECHANICAL ENGINEERING
1228	BE-A-79	NAIK SAHIL UMESH PRIYANKA	MECHANICAL ENGINEERING
1229	BE-A-80	/SORATE AKSHATA ASHOK MANISHA	MECHANICAL ENGINEERING
1230	BE-B-01	NANDE ATHARVA MANOJ	MECHANICAL ENGINEERING
1231	BE-B-02	NANGARE RAHUL JITENDRA LATA	MECHANICAL ENGINEERING
1232	BE-B-03	NANGARE SHIVAM RAMDAS PRANITA	MECHANICAL ENGINEERING
1233	BE-B-04	NARVEKAR SHREEMAY SANJAY SUDHA	MECHANICAL ENGINEERING
1234	BE-B-05	PABLE SUKHJEETSINGH AVTARSINGH JAGDISHKA	MECHANICAL ENGINEERING
1235	BE-B-06	PANDEY PIYUSH RAMSAJIVAN SUMAN	MECHANICAL ENGINEERING
1236	BE-B-07	PANDEY SHASHANK ARUN KUMAR	MECHANICAL ENGINEERING
1237	BE-B-08	PATIL ADITYA KANTILAL ANITA	MECHANICAL ENGINEERING
1238	BE-B-09	PATIL BHAVESH HEMANT BHAVANA	MECHANICAL ENGINEERING
1239	BE-B-10	PATIL DEVENDRA DATTARAM PRAMILA	MECHANICAL ENGINEERING
1240	BE-B-11	PATIL HARISHCHANDRA SURESH KALPANA	MECHANICAL ENGINEERING
1241	BE-B-12	PATIL HRUTIK KISHOR LALITA	MECHANICAL ENGINEERING
1242	BE-B-13	PATIL MANISH ANIL VIJAYA	MECHANICAL ENGINEERING
1243	BE-B-14	PATIL MANTHAN SANTOSH TANUJA	MECHANICAL ENGINEERING
1244	BE-B-15	PATIL NIKHIL RAJENDRA ASHA	MECHANICAL ENGINEERING
1245	BE-B-16	PATIL PRASHANT SHESHERAO UMA	MECHANICAL ENGINEERING
1246	BE-B-17	PATIL PRATHAMESH PRADEEP RAJSHREE	MECHANICAL ENGINEERING
1247	BE-B-18	PATIL SURAJ DHANAJI ANITA	MECHANICAL ENGINEERING
1248	BE-B-19	PATIL TANMAY REVANNATH	MECHANICAL ENGINEERING
1249	BE-B-20	PATIL TUSHMESH LAXMAN VAISHALI	MECHANICAL ENGINEERING
1250	BE-B-21	PATIL UMESH SHRIKRISHNA NISHA	MECHANICAL ENGINEERING
1251	BE-B-22	PATIL VINIT ABHIMANYU MANISHA	MECHANICAL ENGINEERING
1252	BE-B-23	PATIL VIKRANT SANJAY MADHUMITI	MECHANICAL ENGINEERING

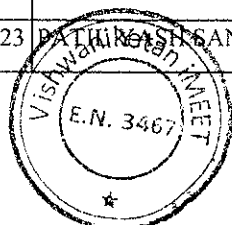

TRUE COPY

Handwritten signature

Vishwaniketan's (i MEET)

1253	BE-B-24	PATLE KSHITIJ JAIKRISHNA JAIKRISHNA	MECHANICAL ENGINEERING
1254	BE-B-25	PAWAR SHUBHAM VISHAL VISHAL	MECHANICAL ENGINEERING
1255	BE-B-26	PAWAR AKASH ANIL	MECHANICAL ENGINEERING
1256	BE-B-27	PAWAR DILIP ARUN ARUNA	MECHANICAL ENGINEERING
1257	BE-B-28	PAWAR KUNAL MOHAN RUPA	MECHANICAL ENGINEERING
1258	BE-B-29	PINJARI PRAJYOT NARAYAN SAVITA	MECHANICAL ENGINEERING
1259	BE-B-30	POL TUSHAR YUVRAJ SAVITA	MECHANICAL ENGINEERING
1260	BE-B-31	RANE OMKAR ANIL ASMITA	MECHANICAL ENGINEERING
1261	BE-B-32	RAUT ABHIJEET MAHADEV SUREKHA	MECHANICAL ENGINEERING
1262	BE-B-33	RODE ONKAR HANUMANT MADHURI	MECHANICAL ENGINEERING
1263	BE-B-34	SALAVI SAURABH SANDIP SANJANA	MECHANICAL ENGINEERING
1264	BE-B-35	SALE SHREYAS SANJAY ANJALI	MECHANICAL ENGINEERING
1265	BE-B-36	SALUNKE ROHIT NARAYAN SAVITA	MECHANICAL ENGINEERING
1266	BE-B-37	SARDAL RUTVIK ARUN PRANITA	MECHANICAL ENGINEERING
1267	BE-B-38	SAWANT ADITYA AVINASH AKSHATA	MECHANICAL ENGINEERING
1268	BE-B-39	SAWANT SAURABH SUBHASH AARTI	MECHANICAL ENGINEERING
1269	BE-B-40	SHAIKH SAMIR JAMIL RAJIYA	MECHANICAL ENGINEERING
1270	BE-B-41	SHELKE RUSHIKESH DATTARAM RATAN	MECHANICAL ENGINEERING
1271	BE-B-42	SHELKE TUSHAR VILAS GANGUBI	MECHANICAL ENGINEERING
1272	BE-B-43	SHENDE SAGAR SOPAN SAVITA	MECHANICAL ENGINEERING
1273	BE-B-44	SHERKAR SHUBHAM SAMBHAJI ASHA	MECHANICAL ENGINEERING
1274	BE-B-45	SHINDE DARSHAN BHARAT NILIMA	MECHANICAL ENGINEERING
1275	BE-B-46	SHINDE PRATHAMESH SURESH ANAGHA	MECHANICAL ENGINEERING
1276	BE-B-47	SHINDE ROHIT RAMCHANDRA HARSHADA	MECHANICAL ENGINEERING
1277	BE-B-48	SHINDE SARVESH TULSHIDAS PRAMILA	MECHANICAL ENGINEERING
1278	BE-B-49	SHIRKE MIHIR RAJENDRA NUTAN RAJENDRA	MECHANICAL ENGINEERING
1279	BE-B-50	SHIRKE SIDDHESH BHARAT LATA	MECHANICAL ENGINEERING
1280	BE-B-51	SHIRSAT PRANAL AVADHUT ROSHANA	MECHANICAL ENGINEERING
1281	BE-B-52	SINGH ANKIT SARVESH NEELAM	MECHANICAL ENGINEERING
1282	BE-B-53	SINGH SAHIL PRATAP SUNITA	MECHANICAL ENGINEERING
1283	BE-B-54	SURYAWANSHI NIKHIL SUNIL	MECHANICAL ENGINEERING
1284	BE-B-55	TANDEL AMEY ANANT ANANDI	MECHANICAL ENGINEERING
1285	BE-B-56	THAKUR PRIYESH JEEVAN SNEHA	MECHANICAL ENGINEERING
1286	BE-B-57	TODKAR SURAJ TANAJI SANGEETA	MECHANICAL ENGINEERING
1287	BE-B-58	UGALE VAIBHAV VISHNU CHHABUTAI	MECHANICAL ENGINEERING
1288	BE-B-59	VERMA NAGENDRA BABULAL ARCHANA	MECHANICAL ENGINEERING
1289	BE-B-60	VISHWAKARMA SHIVAM SHRIRAM TARA	MECHANICAL ENGINEERING

TRUE COPY

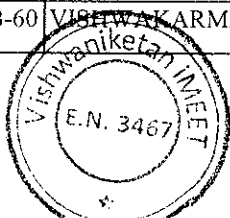

[Signature]
Principal
Vishwaniketan's (I MEET)

1290	BE-B-61	VISHWAKARMA SOURABH DWIPCHAND ULMILA	MECHANICAL ENGINEERING
1291	BE-B-62	VITKAR ATHARVA PRASAD SWATI	MECHANICAL ENGINEERING
1292	BE-B-63	WAGHE TANMAY ANIL ADITI	MECHANICAL ENGINEERING
1293	BE-B-64	WAIRAGADE MAHESH PRABHAKAR RAJNI	MECHANICAL ENGINEERING
1294	BE-B-65	ZORE CHANDU BABU JANABAI	MECHANICAL ENGINEERING
1295	BE-B-66	GAIKWAD SAHIL SANJAY	MECHANICAL ENGINEERING
1296	BE-B-67	JANGAM OMKAR VIJAYKUMAR	MECHANICAL ENGINEERING
1297	BE-B-68	KHAI RNAR HARSHAL AMRUT	MECHANICAL ENGINEERING
1298	BE-B-69	KOLI OMKAR CHANDRAKANT	MECHANICAL ENGINEERING
1299	BE-B-70	ATURDE VISHWAJEET (PRO)	MECHANICAL ENGINEERING
1300	BE-B-71	AUSARMAL AJIT ATMARAM (PRO)	MECHANICAL ENGINEERING
1301	BE-B-72	KAMAT SHANKNIL SATISH (PRO)	MECHANICAL ENGINEERING
1302	BE-B-73	MAHADIK ANIKET BALIRAM (PRO)	MECHANICAL ENGINEERING
1303	BE-B-74	MASKE BUDDHBHUSHAN SANTOSH (PRO)	MECHANICAL ENGINEERING
1304	BE-B-75	MHATRE PRATIK PRAKASH (PRO)	MECHANICAL ENGINEERING
1305	BE-B-76	MOHITE AJINKYA RAMCHANDRA (PRO)	MECHANICAL ENGINEERING
1306	BE-B-77	SAKPAL MIHIR VIJAY (PRO)	MECHANICAL ENGINEERING
1307	BE-B-78	VHORE SHYAMSUNDAR KESHAV (PRO)	MECHANICAL ENGINEERING
1308	BE-B-79	JADHAV AVINASH BALKRISHAN	MECHANICAL ENGINEERING
1309	BE-B-80	CHOUGULE AKSHAY BAPURAO	MECHANICAL ENGINEERING
1310	BE-B-81	RADHAKRISHNAN ANIRUDHA	MECHANICAL ENGINEERING



TRUE COPY

[Handwritten Signature]

Principal

Vishwaniketan's (i MEET)



Vishwaniketan's

Institute of Management Entrepreneurship & Engineering Technology,
Khalapur- 410202

Programme name	Program Code	List of students undertaking project work/field work/internship	Name of Student
1	Mechanical Engineering	346761210	PINJARI PRAJYOT NARAYAN
56	Mechanical Engineering	346761210	SARANSH YOGENS DRA SACHAN
156	Mechanical Engineering	346761210	SAWANT SAURABH SUBHASH
256	Mechanical Engineering	346761210	GADE SANKET RAMESH
356	Civil Engineering	346719110	PATIL SAMIKSHA HANUMAN
456	Civil Engineering	346719110	DESHMUKH ANKITA VIKAS
556	Civil Engineering	346719110	KARDAK SIDDHANT SHYAM
656	Electrical Engineering	346729310	TANDEL PANKAJ DHANAJI

TRUE COPY

Principal
Vishwaniketan's IMEET

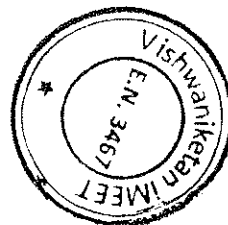



ARCL, a wholly owned sub-factory of JSW Steel Ltd.

Date- 28th April 2020

Sub:- Approval of Industrial Project in Pellet Plant

TO WHOMSOEVER IT MAY CONCERN

This is to certify that,

1. Prajyot Pinjari

2. Suraj Todkar

3. Diptesh Gharat

4. Onkar Ingale,

From Vishwanekatan College of Engineering, to complete their final year Industrial project in ARCL's Pellet Plant on topic "Vertical Rolling Mill grinding oil leakage reduction", under the industrial guidance of Mr. Sharad Thakur.

For Amba River Coke Ltd.

(Contact details- darpangharat@arcl.in & extension no- 02143-256800)

ARCL Ltd.,
Geetapuram, Dcivl- 402107

S.S. Kamble

For ARCL's Pellet plant

(S.S. Kamble, Projects head)



TRUE COPY

[Signature]
Principal
Vishwanekatan's (ARCL)

ECHOBIRD ELECTRONICS LLP

No.77, DDA Market, Lajwanti Garden,
New Delhi 110058
Trade Mark No.(MACJACK) : 4006200
www.macjackwave.com
Ph. 8384019095

Macjack
Sounds Like Celebration

TO WHOMSOEVER IT MAY CONCERN

Date: August 18, 2020

This is to certify that **Saransh Yogendra Sachan**, has successfully completed his **Marketing** internship with **Echobird Electronics LLP** for the period of 1 month. Starting from **14 July 2020** to **14 August 2020**.

During the course of internship. **Saransh Yogendra Sachan** has shown great amount of responsibility, sincerity, and a genuine willingness to learn and zeal to take on new assignments & challenges. In particular, his coordination skills and communication skills are par excellence and his attention to details is impressive.

We wish him all the very best for his future.

With regards,

Team Macjack

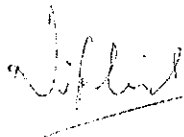
Authorized Signature

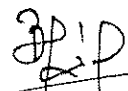

TRUE COPY

Principal
Vishwaniketan's (I MEET)

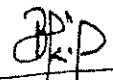
Principal
Vishwaniketan's (I MEET)

Vishwaniketan's
Institute of Management Entrepreneurship & Engineering Technology
2019-2020

CERTIFICATE

This is to certify that the project report titled,
"VERTICAL ROLLING MILL GRINDING OIL LEAKAGE REDUCTION", duly
submitted by the following students

NAME	ROLL NO
MR.PRAJYOT PINJARI	BE-B-29
MR.SURAJ TODKAR	BE-B-57
MR.DIPTESH GHARAT	BE-A-36
MR.ONKAR L INGALE	BE-A-42

has been completed under my supervision in a satisfactory manner in a partial
fulfillment

of the requirements for the award of semester VIII Bachelor's Degree in
Mechanical

Engineering to be conferred by the *University of Mumbai*. In my opinion, the
work

embodied in this report is comprehensive and fit for evaluation.

Project Guide

 (Prof. Sagar Dhotare)
Prof. Bhavesh Pasi

X
HOD

Dr. B. R. Patil

Principal
Principal
Vishwaniketan's (I MEET)



CONTENTS

Table of Content

Sr. No.	Title	Page No.
1	Introduction of Industry	1-8
2	Industrial Problem Definition	9
3	Importance and Significance of Study	10-12
4	Aim and Objectives	13
5	Literature Review	14-22
6	Work Methodology	23-26
7	Analysis of problem	27-29
8	Development of Solution	30-32
9	Result and conclusion	33
10	Completion Letter	35-36
11	References	37-38

Chapter 1. Introduction to Industry

1.1 Introduction to JSW Steel

JSW Dolvi Works is India's first to adopt a combination of Co-narc Technology for both steel-making and compact strip production (CSP), aiding the production of hot rolled coils. From automotive and industrial to consumer durable s, Dolvi manufactures products that meet the needs of companies across sectors. The 5 MTPA integrated steel plant at Dolvi is advantageously located on the West coast of Maharashtra. It is connected to a jetty which can handle cargo of up to 15 MTPA. Conveyor belt used has been manufactured by METSO company. Metso provides world leading products and services built on technological excellence, experience and high safety standards. Company is supported by a global network of over 15000 professionals in more than 50 countries. Pulley used has been manufactured by UTTAM GALVA STEELS LTD company. Uttam Galva Steels Ltd is one of the largest manufacturers cold rolled steel (CR) and galvanized steel (GP) in Western India. The company procures hot rolled steel and processes it into CR and further into GP and colour-coated coils. Uttam Galva group also runs two more plants in India:-Uttam Galva Metallic s Limited and Uttam Value Steels Limited.

1.1 Introduction to Pellet plant

Pelletizing is a process which involves mixing of very finely ground particles of iron ore fines having a size which is less than 200 mesh (0.074 mm) with additives like bentonite and then shaping them into near oval/spherical balls having size in the range of 8 mm to 16 mm in diameter by a pelletizer and hardening the balls by firing with a fuel. It is an agglomerating process of converting iron ore fines into 'uniformed sized iron ore pellets' which can be charged directly into a blast furnace (BF) or into a vertical furnace or rotary kiln normally used for the production of direct reduced iron (DRI). The iron ore pellets are shown in Fig 1.

The typical properties of the iron ore pellets are given below

Typical properties of iron ore pellets		Chemical analysis(on dry basis)		Unit	Value	Tolerance
Fe%	65	Minimum	FeO%	0.3	Maximum	SiO ₂ + Al ₂ O ₃ %
				5	Maximum	CaO%
				0.03	±	
				0.01	MgO%	0.06±
				0.01	Basicity%	65
				Maximum	Phosphorus%	0.05
				Maximum	Physical	

Chapter 9. RESULT and CONCLUSION

Sr. No.	LIST OF PROPOSED SOLUTION	ACCEPTED/REJECTED	REASON
1.	Replace single lip oil seal with double lip oil seal	REJECTED	Already two seal available
2.	Instrument air provided in place of purge air	ACCEPTED	Low cost and minimize failure

Oil Seal View



BEFORE



AFTER

Fig. Oil seal after mainatenance

Vishwaniketan's
Institute of Management Entrepreneurship & Engineering Technology
2020-2021



CERTIFICATE

This is to certify that the project report titled, “Comparisons of performances of car suspensions system using MATLAB Simulink”, duly submitted by the following students-

Name	Roll No.
Salunke Rohit Narayan	B-36
Patil Manish Anil	B-13
Sawant Saurabh Subhash	B-39
Shaikh Samir Jamil	B-40

has been completed under my supervision in a satisfactory manner in a partial fulfilment of the requirements for the award of semester VIII Bachelor's Degree in *Mechanical Engineering* to be conferred by the *University of Mumbai*. In my opinion, the work embodied in this report is comprehensive and fit for evaluation.

Project Guide

(Prof. Ravindra Patil)

Prof. Bhavesh Pasi
HOD

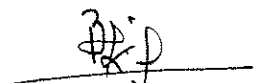

Dr. B. R. Patil
Principal
Principal
Vishwaniketan's (I MEET)

Abstract

The purpose of this project was focused on designing of the best suspension system for the half car model that can provide maximum ride comfort and handling by maintaining vehicles well isolated from road disturbances, bumps and within an acceptable deflection limit by controlling the suspension force to observe or dissipate the energy appropriately. The mathematical modeling of half car for the passive and active suspension system model had been derived. The road disturbances in this project will be simulated by an impulse input. In order to improve the output responses of the system, a state-feedback controller is selected as a fulfillment of this project. To achieve a better simulation, the controller needs to be carefully designed as each system had its own performance and methods. The state-feedback is selected as a controller and the parameters are optimized by Artificial Bee Colony (ABC) Algorithm. MATLAB Simulink will be used in order to simulate the response of the system and to obtain the ride performances between the suspension system using state- feedback controller and the suspension that apply same controller that optimize by ABC algorithm. The acceleration and displacement become the output for this system and the result was analyzed.

CONTENTS

Chapter No.	Title	Page No.
1	Introduction.....	11
	1.1 Motivation.....	12
	1.2 Project Background.....	12
	1.3 Problem Statement.....	13
	1.4 Project Objective.....	13
	1.5 Scope of Project.....	14
	1.6 Suspension system types.....	14
	1.7 Hydraulic actuator model	17
	1.8 Half car suspension system.....	18
	1.9 State feedback controller.....	19
	1.10 Artificial bee colony algorithm.....	20
2	Literature survey.....	22
3	Mathematical Modelling.....	25
	3.1 Overview of Research Methodology.....	26
	3.2 Mathematical Modelling Process.....	28
	3.3 Modelling assumption and identifying.....	29
	3.4 Free Body Diagram and Equation of Motion.....	29
	3.5 Vehicle Parameters.....	36
	3.6 Profile of Road.....	37
	3.7 Simulations and State space.....	38
	3.8 MATLAB Procedure.....	39
	3.9 Simulink Blocks.....	42
	3.10 Artificial Bee Colony Algorithm.....	46
	3.11 Conclusion.....	49
4	Results and Discussion.....	50
	4.1 Controller Input.....	51
	4.2 System Stability.....	52
	4.3 Tuning parameter state feedback with Artificial Bee Colony.....	53
	4.4 Body Acceleration.....	53
	4.5 Body Displacement.....	57
	4.6 Road Profiles.....	59
	4.7 Result Table, Comparisons and Discussions.....	61
5	Conclusion and Recommendations.....	62
	5.1 Conclusion.....	63
	5.2 Recommendations.....	63
	References.....	64

INTRODUCTION:

Nowadays, car is the most important transportation that have been used among people travel from one destination to another. Car production is also increase progressively to the necessities and requirements of consumers. Designing and modeling of car by the factory is different which produced to make sure it fulfills the requirements of consumers based on road handling, load carrying and their passengers' comfort due to conflicting demands. On the other hand, the significance of car suspension systems cannot be emphasized. This is because, it provides a good road holding in order to optimize passengers comfort and maintaining continuously the tires friction between the road surface. It also provides support to the car and equally ensures perfect comfort for the passengers.

1.1 Motivation

It is well known that comfort is one of the key criteria in the structure of a car suspension system. The aim of the car suspension system is to reduce a movement of the car body generated by the surface of road, to protect car body and also to keep the car passenger and for car handling. The suspension system affects the control of the car by both the driver and the comfort of the passenger. The spring makes the tires to move up and withstand bumps on the road, while the dampers avoid bouncing up and down. The car suspension system varies depending on the manufacturer, helping to ensure a wide range of models. The primary role of a suspension system is to ensure the safety function in whatever solution is adopted. One of an important elements in a car is the shock absorber or called as damper, the one which contributes both to driving safety and comfort. It is a device that, through some kind of process known as dampening, controls unneeded spring motion. The shock absorber purpose is to minimize and limit the impact of vibrational motion by transforming kinetic energy to heat energy which can be transferred through hydraulic fluid. The production of car dampers, or shock absorber, is difficult to estimate with precision, as the car's demand increases the existence of shock absorber. The modifications were achieved by making electronic control appropriate for the suspension system to create the best performances. Because of the roll and pitches involved with car and the various roughness of roads the need for dampers increases. So, there was terrific production of the dampers these days.

5.1 Conclusion:

In MATLAB software simulation was used to realize the suspension system. The controller is initially designed on the basis of mathematical modeling as discussed in Chapter 3. Once the optimal controller parameters are determined the diagram of Simulink block will be linked. The Simulink has been designed in MATLAB software by the Simulink model window. The design of the half car model suspension system supposes will perform with state-feedback controller. From research, Simulation result shows that the ABC algorithm optimizations provide a significant improvement to system compared to the conventional system. It is necessary to get the desired rise time, peak time, and control problem settling system time. Choosing the best way to conduct a controller is important because it will provide a desired response of the system.

The theory of the car suspension system was understood and analyzed using a half-car model. The half car suspension system can be simulated based on mathematical modelling followed by the controller tuning process which is state feedback controller. The performance of the half car suspension system between Artificial Bee Colony (ABC) algorithm was compared with conventional state feedback controller. The controller was created by simulation using MATLAB Simulink for the active half car suspension system. There have been some critical problems, mostly in the theoretical part and in the designing of MATLAB Simulink. However, these problems have been successfully resolved and the goal of the project has been achieved. The designed system is in compliance with the design requirements.

5.2 Recommendations:

There are many ideas that can be implement for improvement this project. For future work, it must using higher level of controller instead of state feedback controller. The controllers that can be implemented such as Neural Network Controller, Fuzzy Logic Controller, and PID Controller. A complete suspension system for half car to be controlled can be designed to achieve a better control for half car suspension system performance. This project should design the hardware for car suspension system, but this design needs a very high cost to build the system. Lastly, tuning this system using other algorithm such as Particle Swarm Optimization algorithm, Ant Colony algorithm and Genetic algorithm to compare which can provide more precise performance. For future research to utilize other than state feedback controller must improving the performance of system in real time.

Vishwaniketan's
Institute of Management Entrepreneurship & Engineering Technology

2020-2021



CERTIFICATE

This is certified that the mini project report titled “**Multipurpose Mechanical Machine**” is duly submitted by “*Sahil Bhatkar, Aniket Degaonkar, Omkar Deshmukh and Sanket Gade*” has been completed under my supervision in a satisfactory manner in a partial fulfilment of the requirements for the award of semester IV Bachelor’s Degree in Mechanical Engineering to be conferred by the University of Mumbai. In my opinion, the work embodied in this report is comprehensive and fit for evaluation.



Mr. Rajaram Ghutukade
Mini Project Guide



Mr. Bhavesh Pasi
Head of the Department



ABSTRACT

We presenting project "Multipurpose Mechanical Machine" which finds application in much modern equipment and system work on the various operations like grinding, finishing, cutting, drilling etc. As the prices of drilling, cutting, grinding machine are so high and some are not portable, so we can try to made the multipurpose mechanical machine which are portable. The machine motor not required high power voltage it work on single phase, and power transmitted efficiently by the help of V-belt pulleys.

Introduction

Multi-purpose Mechanical Machine or MPMM as we call it is a machine that is made especially for the small scale industries where labours working are have very little technology .

MPMM it is a machine that performs their work quickly and efficiently without the hassle of using different machines for performing different operations on workpiece. It has Four arms on which four different operations are performed.

Multi-operation machine as a research area is motivated by questions that arise in industrial Manufacturing, production planning, and computer control. Consider a large automotive garage with specialized shops.. Industries are basically meant for Production of useful goods and services at low production cost, machinery cost and low inventory cost. Today in this world every task have been made quicker and fast due to technology advancement but this advancement also demands huge investments and expenditure.

Every industry desires to make high productivity rate maintaining the quality and standard of the product at low average cost. In an industry a considerable portion of investment is being made for machinery installation. So in this project work is proposed where a machine is designed cutting, drilling, grinding, polishing& shaping, some lathe operations at different working centers simultaneously which implies that industrialist will not have to pay for machine performing above tasks individually for operating operation simultaneously. Economics of manufacturing: According to some economists, manufacturing is a wealth-producing sector of an economy, whereas a service sector tends to be wealth consuming. Emerging technologies have provided some new growth in advanced manufacturing employment opportunities in the Manufacturing Belt in the United States. Manufacturing provides important material support for national infrastructure and for national defense. Before starting our work we have undergone through many research papers which indicates that for a production based industries machine installation is a tricky task as many factor being associated with it such as power consumption (electricity bill per machine), maintenance cost, no of units produced per machine i.e. capacity of machine, time consumption and may which can perform operations like drilling, cutting, grinding, polishing & shaping .

CONCLUSION

The conclusion can be made that the project on multipurpose machine considering economic aspect of production is performing well and with certain modifications can easily use in small scale industry successfully. The purpose is to perform four operations at a time is achieved, since all the operations mounted on a rectangular frame made of mild steel, when power is supplied, cutting by hacksaw and drilling is performed on same shaft and able to cut and drill wood, pvc because of lack in speed and light weight construction.

Similarly on other shaft at one end grinding of wood, pvc and aluminium is successful done, as grinding wheel consist of abrasive particle bonded together in circular shape and cut down small irregularities and provide flat surface, on other end of the shaft buffing operation is take place which provide shiny surface.



Vishwaniketan's Institute of Management Entrepreneurship
and Engineering Technology

A Report On: Intensive Training (Heavy Water Plant – Electrical Department)

Prepared By: Pankaj Dhanaji Tandel

Industry Name: RCF Limited, Thal

Under Guidance Of: Mr. D.M.Ramteke (Assistant General Manager (HRD))

Prof.Nikhil Kasar

Mr.N.K.Shelke

Mr.Umakant Bakhhal

Time Period Of Training: 12thOctober 2020 to 26thOctober 2020

Acknowledgement

It's my prestige to get training in such a huge government industry RCF LTD. A special thanks to Dr. B.R. Patil Sir (Principal Vishwaniketan IMEET) for giving me & Mr. D.M.Ramteke (Assistant General Manager HRD), for giving me an opportunity to get training over here from experienced faculties,it was my pleasure to understand and experience all equipment , process of Heavy Water Plant.

I would like to thanks Mr.N.K.Shelke & Mr.Umakant Bakhai for helping me throughout the training & ensuring that we understand the plant efficiency .Lastly I would like to thank all employees and workers of Heavy Water Plant for providing me the technical knowledge & their experience help me with duty and for providing information for completion of report

Thanking You,

Pankaj Tandel

INDEX

Sr. No.	Topics
1	Overview of RCF Limited
2	Overview of RCF Thal
3	Overview of Heavy Water Plant
4	Interlocks and Tripping system in plant
5	Functioning of MCC & Electrical Substation
6	HT & LT motors and its protection
7	Circuit Breakers
8	UPS & Batteries
9	Electrical power distribution system
10	Electrical Measuring Instrument
11	Transformer
12	Electrical Safety Measurement Taken in plant
13	Reference

TABLE OF ABBREVIATION

Sr.no.	Abbreviation	Definition
1	RCF	Rashtriya Chemicals & Fertilizers
2	MT	Metric Ton
3	STP	Sewage Treatment Plant
4	MLD	Million Liters per Day
5	CT	Current Transformer
6	PT	Power Transformer
7	UPS	Uninterruptable Power Supply
8	HT	High Tension
9	LT	Low Tension
10	ACB	Air Circuit Breaker
11	VCB	Vacuum Circuit Breaker
12	NH ₃	Ammonia

Abstract

Industrial training is an important phase of a student life. A well planned, properly executed and evaluated industrial training helps a lot in developing a professional attitude. It develop an awareness of industrial approach to problem solving, based on a broad understanding of process and mode of operation of organization. The aim and motivation of this industrial training is to receive discipline, skills, teamwork and technical knowledge through a proper training environment, which will help me, as a student in the field of Electrical Engineering, to develop a responsiveness of the self-disciplinary nature of problems in Electrical Engineering. During a period of 15 days training at RCF(Thal).

In HWP I learned about MCC & PCC. Working of interlocks and tripping system in emergency case. I learned what to do in power failure in industry. I learned about HT & LT motors ,maintenance and precaution to be taken on field. I leaned about Electrical power distribution in HWP. Function of DG set and UPS system.

1] OVERVIEW OF RCF LIMITED

Rashtriya Chemicals & Fertilizers Limited (RCF), a “Mini-Ratna”, is a leading fertilizers and chemicals manufacturing company with about 75% of its equity held by the Government of India. It has two operating units, one at Trombay in Mumbai and the other at Thal, Raigad district, about 100 KM from Mumbai.

RCF manufactures Urea, Complex Fertilizers, Bio-fertilizers, Micro-nutrients, 100 per cent water soluble fertilizers, soil conditioners and a wide range of Industrial Chemicals. It produces around 24.0 Lakh MT Urea, 5.0 Lakh MT Complex fertilizers and 4.5 Lakh MT of Industrial Chemicals every year. The company is a household name in rural India with brands “Ujjwala” (Urea) and “Suphala” (Complex Fertilizers) which carry a high brand equity. RCF has countrywide marketing network in all major states. Besides fertilizer products, RCF also produces a large number of industrial chemicals that are important for the manufacture of dyes, solvents, leather, pharmaceuticals and a host of other industrial products.

The “Make in India” mission was launched by the Hon’ble Prime Minister, Shri Narendra Modi in September 2014 with an objective to give the Indian economy sustainability and global recognition. The government is committed to transforming India into a global manufacturing hub, while ensuring that manufactured goods have ‘zero defect’ and ‘zero effect’ on the environment.

In consonance with the PM’s mission and Vision 2022, RCF endeavors to be one of the main driving forces behind India’s sustainable agriculture. RCF is one of the earliest units set up in the country with a vision of growth in fertilizer production for food security. The company was the first in the country to produce complex fertilizer which was introduced in the market in 1967 under the brand name “Suphala”. RCF took the lead in the country in setting up mega size fertilizer complex at Thal which was commissioned in the year 1985 and after that many more domestic mega plants followed suit. The company also made significant contribution in the great “Green Revolution” of the nation. RCF has also pioneered the manufacture of basic chemicals such as Methanol, Ammonia, Ammonium Nitrate, Sodium Nitrate, Sodium Nitrite, Ammonium Bicarbonate, Methyl amines, Dimethyl Formamide, Dimethyl acetamide, Formic Acid, Argon in India. RCF has been successfully operating a Sewage Treatment Plant (STP) of 22.75 MLD (Million Liters per Day) sewage capacity at Trombay unit since January 2000. RCF and BPCL have entered into MOU for new STP Project at RCF- Trombay. RCF shall supply around 40% of the treated water to BPCL. In its bid towards India’s vision of achieving ecologically sustainable growth, RCF has already forayed into solar power generation. RCF has set up a 2 MWp ground mounted Photovoltaic Solar power plant within the factory premises and an aggregate capacity of 1.29 MWp solar rooftop facilities.

At present, there is a deficit of indigenously produced urea in meeting India’s total requirement which is being met through imports. In order to augment the domestic urea capacity to fill this gap and achieve self-sufficiency in line with the ‘Make in India’ mission, RCF in association with GAIL, CIL and FCIL has taken up revival of FCIL’s unit at Talcher based on Clean Coal Technology. The project entails setting up Urea plant of 1.27 million MT per annum capacity. In order to utilize country’s huge coal reserves, Talcher Fertilizers

will be a game changer for India in terms of opening a new avenue in coal gasification and shall reduce dependency on Natural Gas for Urea manufacturing. Department of Fertilizers (DoF) has nominated RCF for 52% equity in Namrup IV project in BVFCL, along with Oil India Ltd., Govt. of Assam and BVFCL holding 26%, 11% and 11% equity respectively in joint venture for setting up of Namrup unit of Brahmaputra Valley Fertilizer Corporation Limited. The proposed project entails setting up a Urea plant with an annual capacity of 1.27 Million MT. Apart from the proposed fertilizer projects in India, RCF is also looking for opportunities, for setting up Joint Venture Projects abroad in resource rich countries.

“Make in India” also lays emphasis on the principle that sustainability should not be confined to the continuity of economic progress alone, but should imply a resolve that the country would not compromise on its commitment towards environment protection.

Since inception, RCF has successfully and safely operated two dozen chemical and fertilizer plants for the past five decades at Trombay. The company has operated plants at Thal for past three decades and maintained the quality of environment. This itself has been a huge challenge and demonstrates company’s commitment towards environment and concern about the neighborhood. RCF has spent more than Rs.400 Crore over the years in various pollution abatement and environment improvement schemes.

RCF has always striven for upkeep of the plants through modernizing and upgrading technology. Revamping and de-bottlenecking is the secret that has kept the company thriving for five decades. This has facilitated plants to sustain operations and meet technological challenges of improved efficiency, lower energy consumption and meet the environment norms. It has also resulted in company achieving the highest standards of safety and product quality. The company is maintaining ISO 14001 accreditation for environment since the last seventeen years. Both the manufacturing units are accredited with ISO 9001 for quality, OHSAS 18001 for Occupational Health and Safety and ISO 50001: 2011 for Energy Management System.

Agriculture is the mainstay of the Indian economy, being the source of employment for more than 50% of the population. The connection between agriculture and ‘Make in India’, ‘Vision 2022’ will promote economic security of farmers. The objectives of which can be enunciated as: a) Improved professionalism in agri-business b) Increased private investments in agriculture support activities like irrigation projects, research and development, training etc. c) Improved agri-metrics like yield per hectare etc. and d) Improved agri-produce marketing and sales.

RCF has sought to bridge the gap between Research Scientist and the farmer by setting up dedicated Farmer Training Centers at Nagpur and Thal. RCF publishes a monthly farm magazine “RCF Sheti Patrika” (since 1967) which disseminated latest agricultural information & practices to the farming community. This magazine is distributed free of cost to the farmers and presently it has a readership of over 1.50 lakh farmers. The company has also introduced a “Toll Free Helpline – 1800 22 3044” service through which the farmers can get advice and suggestions on their agriculture and farming related queries. RCF has launched a page named “RCF Kisan Manch” on Facebook, Twitter, Youtube and Instagram to facilitate easy interaction with stakeholders and for creating awareness about activities undertaken by RCF. Mobile App “RCF Kisan Manch” has also been launched since Oct 2017.

To promote balanced use of fertilizers for improving the farm productivity and also to help in maintaining soil health, RCF has established 13 (Thirteen) static Soil Testing Laboratories (STL) in the country at strategic locations, namely Mumbai, Kolhapur, Nagpur, Ahmednagar, Hassan, Vijayawada, Lucknow, Kolar, Suryapet, Raipur, Nanded, Satara and Latur covering the soil testing activity in the districts around these STLs. In addition to the static STLs, the company also operates 6 (six) Mobile Soil Testing Labs. More than 1.25 lakh soil samples are analyzed per year in these labs and Soil Health Cards are issued to the farmers. RCF is giving farmers welfare programs like Kissan Suvudha Kendra, Urban Marketing through e-commerce platforms, farmers knowledge centres, Live field demonstration, crop literature, community Radio, Kissan knowledge centers, Krishi melas etc. This service is rendered free of cost to farmers.

RCF also strongly believes in discharging its Corporate Social Responsibility diligently with and objective to benefit the needy and for general good of the society. A host of CSR activities are undertaken by the company which includes adoption of villages, providing drinking water, providing schooling facilities and scholarship, providing Mid-day-meal, Community Medical facility through Mobile Medical Van, special measures of SC/ST and under privileged, organizing "Adivashi Kabaddi tournament" to motivate sports activities in tribal and rural area, providing training to farmers etc. This way the company is producing engineers to contribute and take forward the "Make in India" mission and vision 2022.

RCF has been performing well for the last several years and in one of the few PSU's which have been posting profits consistently. RCF has been performing well for the last several years and in one of the few PSU's which have been posting profits consistently. The company has achieved revenue from operations of Rs.8885.47 Crore with the net profit of Rs.139.17 Crore in the last financial year 2018-19.

2]OVERVIEW OF RCF THAL UNIT

Rashtriya Chemicals & Fertilisers Ltd. (RCF) is an Indian urea and ammonia producer with headquarters in Mumbai (formerly known as Bombay) in India. Although the urea and ammonia industry has been deregulated in India, RCF is state owned. This may change as the Indian government pursues a slow privatisation policy. In late 1999, the Disinvestment Commission proposed cutting the government shareholding from more than 90% to 49%.

The expansions will allow higher capacity utilisation of the RCF plant. Of course, this will maximise return on assets. It was also intended to reduce the amount of energy needed for a given amount of ammonia, since there was a shortfall in natural gas supply.

THAL MAHARASHTRA COMPLEX

RCF decided to revamp its Thal (Maharashtra) complex in two phases. The first ended in 1996, and the second in June 1999. The company now has a third, much greater, expansion planned.

It planned to expand its ammonia plants in two phases. The first began in 1996, and was intended to increase production to 1,500t/day. The second phase was to increase the capacity of each plant to 1,600t/day.

In the initial phase, which took 30 months and cost Rupee 880 million, RCF installed a new process air compressor unit, a new hydrogen recovery unit, a new cooling tower and new pumps. It also converted its steam generation boilers, auxiliary boilers and steam superheaters to naphtha/natural gas and replaced reformer tubes, condensate stripper trays and other equipment.

Basic engineering was carried out by Haldor Topsoe. Detailed engineering was executed by Projects & Developments India Ltd (PDIL).

HYDROGEN RECOVERY UNIT AND CO₂ RECOVERY UNIT

The hydrogen recovery unit was intended to recycle hydrogen that had previously been used as fuel. This resulted in a 4% increase in ammonia production. The hydrogen fuel was replaced with natural gas.

The new tubes were made from Manurite 36XM in order to heighten the threshold of the tube-wall temperatures. The thinner tube walls also allow higher catalyst volume and a reduced pressure drop.

The CO₂-removal unit had to be upgraded to accommodate increased load. This allowed the absorber to handle process gases equivalent to 1,500t/day with a CO₂ slip of less than 800ppm. This contrasts with the status quo ante which used a CO₂ slip of 1,000 ppm to produce 1,350t/day.

Sulzer Industries trays were used as replacements in the process condensate stripper. The downcomer area was increased by about 9%. This allowed a better mass-transfer coefficient and increased capacity.

The existing two process-air compressors could handle 2,700t/day of ammonia (with the instrument-air compressor grid). A new third air compressor was necessary to produce the 3,200t/day of ammonia expected of Phase II.

SECOND-PHASE PROCESS IMPROVEMENTS

The second phase was intended to replace gas and converted gas boilers (which were causing problems), modify a circulation pump and the syngas compressor, install additional separators, a new refrigeration system and a suction chiller for the compressor.

To accommodate the greater load the syngas compressor barrels and the steam-turbine inlet-nozzle box were redesigned and the steam drum was replaced. Two new chillers have been added, providing new refrigeration. The pumps needed new impellers in order to process the much increased quantities.

The boilers had to be replaced due to damage from previous power outages (India has notoriously unreliable power supplies). A suction chiller added to the exit of the methanator is designed to improve the syngas compressor's efficiency.

FURTHER EXPANSION

RCF has plans to expand its Thal urea plant again, provided the government approves. The proposed expansion would add 768,000t/yr. However, the new extension would be unlikely to come into production until 2002/2003. The proposed expansion would cost slightly over \$300 million. Despite this, RCF has already arranged feedstock supply with Enron, which it hopes will solve its gas supply difficulties.

RCF has also been linked with a proposed fertiliser plant in Oman, although it is not clear whether it will press ahead. The company may also plan a plant to produce methylamines and its derivatives in India.

3]OVERVIEW OF HEAVY WATER PLANT

Heavy Water Plant Thal is the first of second-generation plants in India and is made completely with indigenous efforts. The vast technical resources available with Heavy Water Board with the experience gained by commissioning and sustained operation of the earlier plants were utilised for setting up of the plant. It is located at Thal-Vaishet village in Raigad district of Maharashtra and is about 100 kms south of Mumbai on National Highway No.17. It is about 20 kms away from Pen railway station of Panvel - Roha section. The site is also accessible from Gateway of India, Mumbai by Catamaran services. HWP Thal was commissioned in 1987. Setting up of the plant was a major task as a number of components were to be developed for the first time indigenously. Some of them were special tower internals, canned motor pumps, glass seals, mass spectrometers, multilayer vessels etc. and this involved considerable pre-project effort by Heavy Water Board.

Process Description

The plant comprises of two streams consisting of two separate isotopic exchange units, final enrichment units, final production units & cracker units, but a common ammonia synthesis unit. Feed synthesis gas (a mixture of one part of nitrogen and three parts of hydrogen containing deuterium from the Ammonia plant) is routed through the plant at a flow rate of about 96 T/Hr. at a pressure of about 180 kg/cm².

The pressure of the gas is first raised by 40 kg/sq.cm. by a booster, to take care of pressure drop. It is then cooled in a heat exchanger by the outgoing cold gas returned from the plant. The gas is thereafter passed through a purification unit. In this unit the oxygenated impurities contained in the gas are removed and the gas is saturated with ammonia.

The purified synthesis gas saturated with ammonia is then passed through the first isotopic exchange tower working at -25°C where deuterium in the gas is transferred to a counter current stream of liquid ammonia containing potassium amide catalyst fed from the top of the tower. The deuterium enriched ammonia from the bottom of the exchange tower is then fed to the second isotopic exchange tower where it gets further enriched by coming in contact with the enriched synthesis gases obtained by cracking of enriched ammonia. A part of the enriched gas and liquid from the second isotopic exchange tower is then taken to the final enrichment section where the concentration of deuterium in the ammonia can be further increased as desired upto 99.8%. Finally, the enriched ammonia so obtained is made free of the catalyst and is cracked. A portion of this enriched synthesis gas is burnt to produce heavy water. However, for reasons of better recovery efficiency the concentration of deuterium in ammonia in the final enrichment section is kept low so as to produce heavy water of about 60% which is then vacuum distilled to produce heavy water of nuclear grade.

The cold synthesis gas depleted in deuterium from the first exchange tower, before its return to Ammonia Plant, is heated by the incoming feed gas from the same plant and is passed through an ammonia synthesis unit. In this unit, a portion of the synthesis gas equivalent to the amount of the ammonia cracked in the crackers is converted into liquid ammonia and fed to the top of first exchange tower. The rest of the depleted synthesis gas equivalent to the feed gas supplied is returned to the ammonia plant. The power to the plant is supplied by

Maharashtra State Electricity Board from their 100 KV grid. The fuel for heating of the crackers of the plant is natural gas, which is supplied by GAIL. This plant is operated and maintained under an O & M agreement.

Some of the special features of the plant are:

- HWP (Thal) is the first heavy water plant in the country based on the ammonia-hydrogen exchange process, which has been set up without foreign collaboration. The basic design of isotopic exchange unit was developed in-house
- The plant adopts the latest technology using micro-processor based distributed digital control system for instrumentation and process control instead of the conventional pneumatic analogue system. The system provides supervisory and monitoring functions for feed control stations. It displays and records data acquired from the plant system and has facilities for data logging and printing alarm messages.
- This plant comprises of two streams with some common units like synthesis unit, sub-station, inert gas unit, instrument air unit, catalyst preparation unit, cooling towers etc.
- Completion of the project has been successfully achieved without any time overrun

SALIENT DATA OF HEAVY WATER PLANT(THAL)	
Process Used	Ammonia-Hydrogen Mono-thermal Exchange
Capacity of the Plant	90 MT / Year
Date of Commissioning	February 1987
Capital Cost of the Plant	Rs.15600 lakhs
Operating Pressure	220 kg/cm ²
Synthesis Gas Flow Rate	96 Te/Hr (48 Te/Hr in each stream)
Total Weight of Structure	7600 Te
Total Weight of Equipments	4400 Te
Maximum Height of Towers	40 M approx.

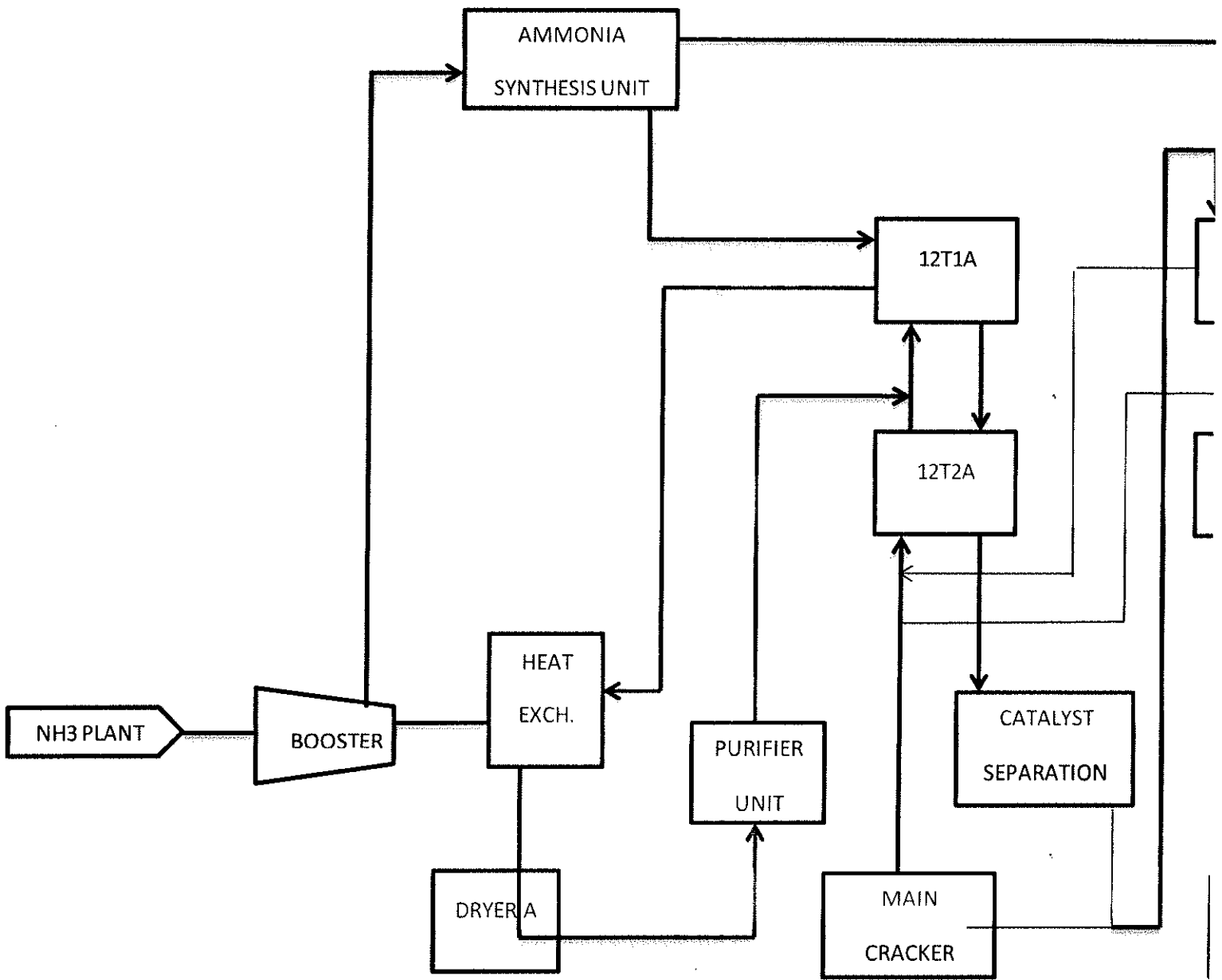

Interlock systeme in plant:

The interlock consist of one or more switches that prevent both main power and generation. Most interlocks devices for electrical system employs a mechanical device to manage movement of circuit breaker.

In this plant interlocks use two contactor in antiparallel connection means If we switch on the contactor C1 the contactor C2 will switch off.

Tripping System in plant:

Overload circuit is the most common for circuit breaker tripping. It occurs when a circuit is attempting to draw a greater electrical load than it is intended to carry . Hence, the breaker or fuse is intended to trip or blow before the circuit wire can heat to dangerous level.

The circuit breaker trips when it cannot handle excess current load. That means flow of electricity is cutoff to keep your circuits safe from overheating or causing more damage.

Functioning of MCC :

MCC is the assembly to provide power to electrical motors through dedicated feeders from central location. Also, from MCC motor controlling is done. MCC consist of power bus, incomer, bus coupler, feeders, circuit breakers, etc.

There are 10 MCC in HWP which works on 3 phase 415 V AC supply. Stepdown transformer of 11kv/415V use to give supply to LT motors. There is bus coupler in MCC which is use when one supply line is carry the load of other motors with its full load efficiency.

Control of MCC is done by PCC . In MCC consist of one number of normal bus coupler which connect both normal bus during tripping of any one incomer is automatically . There is emergency bus coupler which fed power to emergency bus during normal condition through incomer 2 where both normal incomer trips emergency bus coupler automatically trips then due to under voltage relay DG set start and subsequently DC incomer get start and provide emergency power to emergency bus. In MCC there is make such provision that only critical load is given on emergency bus. All incomer and bus couplers are on-off through ACB.

Electrical Substation:

In industry there are two types of substation

- 1) Outdoor sub-station
- 2) Indoor sub-station

In HWP indoor sub-station is used.

A substation in which the apparatus is equipped inside the substation building is called indoor substation. Such type of substation are mainly used for the voltage upto 11KV but when the surrounding air is contaminated by impurities such as metal corroding gases and burners,conductive dust,etc. their voltage can be raised upto 33KV to 66KV.

The substation is subdivided into several compartment like control compartment indicating and protective devices compartment, main busbar compartment, current transformer and cable sealing compartment.

The switchgear on the supply or primary side will consist of MOCB only.The high voltage supply is given to the primary of the transformer through a circuit breaker from the bus bar, various feeders emergency circuit. The panel on each feeder consist of an isolator switch & circuit breaker the panel also provided the measuring instrument.

H.T motors and its protection:-

In industry high tension i.e. motors supplied by high voltage such as 3.3 kv and 11 kv motors. This motors have power rating of more than 150 KW. In hwp DOL starter and star delta starter are used for HT motors.

There are three 4.2MW motors in HWP which are connected through star delta starter and other motors are connected in DOL starter.

Protection of HT motors:

- Should protect against abnormal operating conditions as well as faults in the system which is connected.
- Selection of suitable protection system depends upon voltage and power rating of motor.

In general motors are protected from:-

1. Overload
2. Short circuit
3. System faults
4. Switching overvoltages

LT motors and its protection:-

In industry low tension i.e LT motors having voltage supply of 415 V are connected with DOL starter.

Relays are ACB are used for protection of LT motors.

Protection of LT motors:-

- Thermal overall protection
- Short circuit protection
- Under voltage protection
- Negative phase sequence protection
- Earth fault protection
- Overall voltage protection

Circuit Breakers:-

A circuit breaker is a piece of equipment which can

- i. Make or break a circuit breaker either manually or by remote control under normal conditions
- ii. Break a circuit automatically under fault condition.
- iii. Make circuit either manually or by remote control under normal conditions.

Operating Principle:-

A circuit breaker essentially consists of fixed and moving contacts called electrodes. Under normal operating conditions these contacts remain closed and will not open automatically until and unless the system becomes faulty. Of course the contacts can be opened manually or by remote control whenever desired. When a fault occurs on any part of the system, the trip coils of the circuit breaker get energised and the moving contacts are pulled apart by some mechanism, thus opening circuit.

When the contacts of a circuit breaker are separated under fault condition, an arc is stuck between them. The current is thus able to continue until the discharge ceases. The production of arc not only delays the current interruption processes but it also generated enormous heat which may cause damage to the system or to the circuit breaker itself. Therefore, the main problem in a circuit breaker is to extinguish the arc within the shortest possible time so that heat generated by it may not reach a dangerous value.

Three types of circuit breaker are used in HWP .

1. For HT motors vacuum circuit breaker is used. In vacuum circuit breaker (VCB) arc quenching take place in vacuum and the technology is suitable for HT motors

Protection:

- i. Check vacuum chamber
 - ii. Check contacts
 - iii. Maintain pressure at 10^{-6} bar
2. Oil circuit breaker are replaced with VCB in HWP plant for better protection.
3. Air circuit breaker also used in HWP for LT motors.

UPS and Batteries:

UPS means uninterruptable power supply. UPS gives uninterrupted power supply at any condition . In this plant UPS1 & UPS2 are used. The total rating of UPS is 125KVA.In each UPS 180 batteries of 2.2 V are connected in series which gives practically 200V of supply.

This device is used for emergency conditions such as power failure. In such condition UPS have 10hrs of battery backup for running critical motors & lightning in plant.

After such emergency conditions when power supply get continue then UPS gets charged with boost charger . Then it keeps charged using float charger which gives continuous supply to UPS under normal condition.

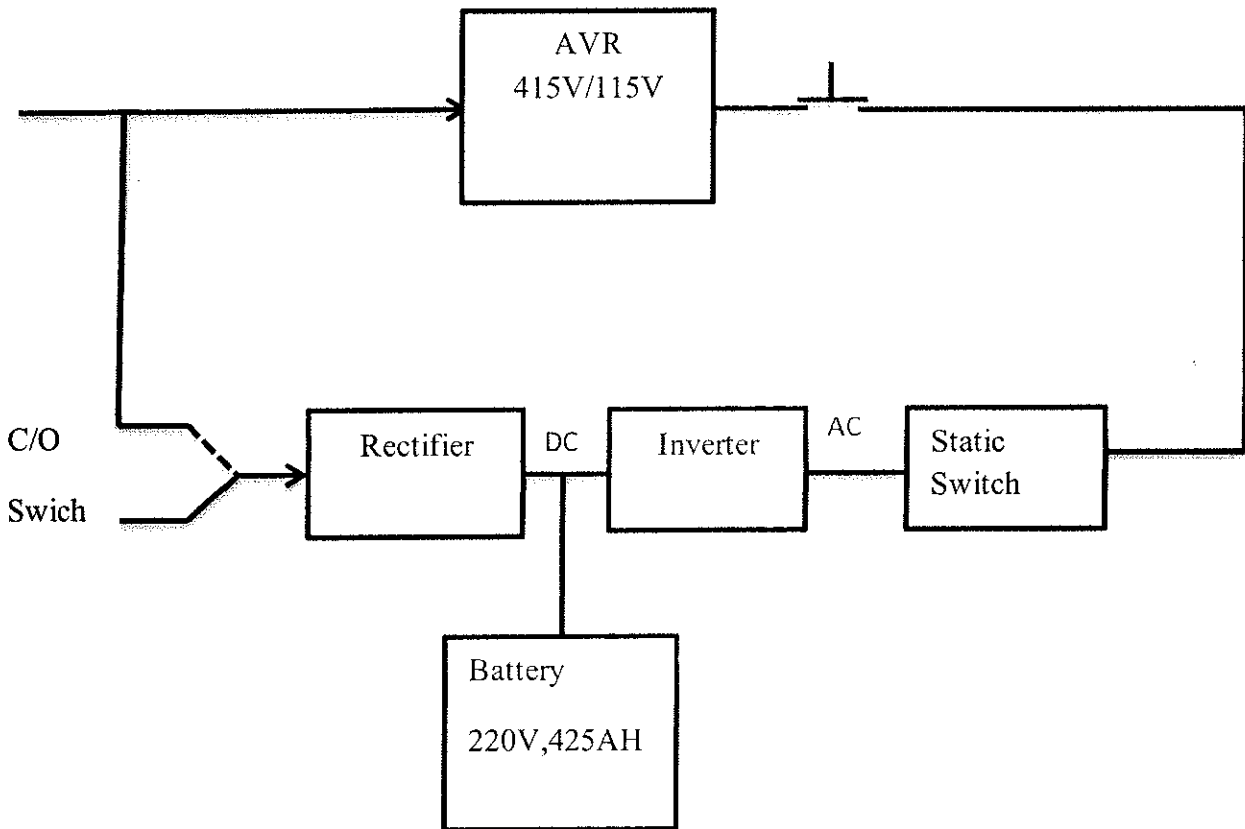

Fig. Block Diagram of UPS

UPS output supply is used for following things:

- PLC-SCADA
- PC
- Control supply
- Instrument Panel
- Emergency light
- Smoke detector

Maintainace:

Improve power quality like

- a. Voltage Regulation
- b. Stand by source
- c. Harmonic filters
- d. Surge protection device

Batteries:

Data:

Manufacturer : Exide industrial

Capacity : 425Ah

Float Voltage: $2.25^+_{-0.02}V$

Electrical Power Distribution System :-

Electrical energy has been extensively used in operation of HWP Thal. The source of this energy is from MSEB with emergency power load having diesel generator set, UPS backup installed in substation. Actually the plant is almost entirely dependent on supply through MSEB. DG set and UPS power are used in case of power failure and in emergency for safe shutdown of plant. Power is received from MSEB by to parallel double circuit 3-phase 100kv line to MSEB station at Thal.

1. 100kv switch yard :

Heavy water plant is getting power from MSEB at 100kv parallel lines. There is 100kv switchyard having two 100kv/11kv . 25/35MVA transformers and associated equipment like 100kv isolaters VCB, CT's, LA's, etc. PT signals are receiving from MSEB switchyard. Power is brought to main substation by 18 numbers of 800 sq.mm single core armoured cables bundles 3 number for each phase.

2. Main substation :

Main substation is having 11kv switchgear, 3.3 KV switchgears, 415v PCC's and MCC's, DC. Distribution system UPS system, Battery room, emergency power distribution board, lighting power distribution boards, ventilation system transformers, series reactors and DG set.

Power failure and backup classes :

Class 1 = Battery

Class 2 = UPS

Class 3 = DG set

Class 4 = Power taken from MSEB

Electrical Measuring instrument:

1. CT (current transformer):

It is used to measure and protect over current in transformer.

2. PT (Potential Transformer)

It is used to measure overvoltage and protect transformer.

3. Clamp meter:

It is used to measure high current flowing through the cable without cutting it.

4. Megger:

Megger is important measuring instrument . It is used to measure IR value in winding.

5. Multimeter:

It is used to check continuity of electrical parts.

6. Earth tester:

Earth tester is device which is used to measure Earth resistance for neutral resistance purpose & earth resistance purpose.

Transformer:

Transformer is a static device used to step up or step down power without changing in frequency.

In HWP generally step down transformer is used. There are nine transformers in HWP.

- 1) 11/3.3KV , 6MVA
- 2) 11KV/415V , 2MVA

Maintenance:

- 1) Check oil level,oil cap
- 2) Check leakage oil
- 3) Check colour get in breather.

Electrical safety measurement taken in plant:

- **Isolation of system:**
Make sure our system must be isolated from electrical supply.
- Do not work on any system in ON line condition because high power is travelling in bus.
- While working remove all buses and isolator be in off position.
- **Use isolating rubber gloves:**
Isolating rubber gloves will do the job of protecting the worker against electrical shocks.
- **LOTO system (Lock Out Tag Out):**
In this if we want to isolate the MCC or substation panel , then we put danger tag to MCC panel at both front and back side and lock the MCC panel . If any person show this tag then they do not work on this panel because bus already changed.

Reference

- www.google.com
- www.refltd.com
- Principles of power system by VK Mehata.

PROJECT REPORT
ON
**USE OF INDUSTRIAL WASTE WATER IN
CONCRETE**

Submitted in partial fulfillment of requirements of the degree of Bachelor
of engineering

By

Sagar Manubhai Bhorling (A-13)

Megha Dinkar Bhujbal (A-14)

Ankita Vikas Deshmukh (A-26)

Kalpesh Laxman Gaikwad (A-34)

Guided By: Prof. Pallavi Dongare



VISHWANIKETAN

Department of Civil Engineering
Vishwaniketan's Institute of Management Entrepreneurship and
Engineering Technology, Khalapur

University of Mumbai

Academic year (2020-21)

TRUE COPY



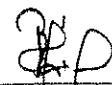

Principal
Vishwaniketan's (I MEET)

CERTIFICATE

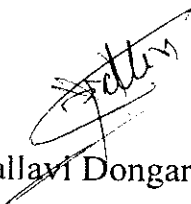
This is to certify that the project entitled "USE OF INDUSTRIAL WASTE WATER IN CONCRETE" is a bonafide work of "Sagar Bhoring, Megha Bhujbal, Ankita Deshmukh, Kalpesh Gaikwad" submitted to the University of Mumbai in partial fulfillment of the requirement for the award of the degree of "Undergraduate" in "Civil Engineering".

(Prof. Pallavi Dongare) Project Guide

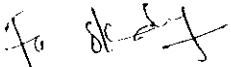

(Prof. Ankit Singh)
Project Co-Ordinator

(Dr. Shilpa Deshpande)
Head of Department

(Dr. B. R. Patil)
Principle

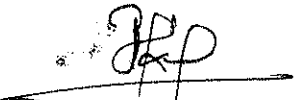

TRUE COPY

Principal
Vishwaniketan's (i MEET)

APPROVAL SHEET

Project Report Approval for B.E

This project report entitled "USE OF INDUSTRIAL WASTE WATER IN CONCRETE" by "Sagar Bhorng, Megha Bhujbal, Ankita Deshmukh, Kalpesh Gaikwad" is approved for the degree of "Bachelor of Engineering" in "Civil Engineering" from "Mumbai University".

Examiners

1. _____
2. _____

Date:

Place:

TRUE COPY



Principal
Vishwaniketan's (I MEET)

ABSTRACT

Water is a basic need of living beings. So, everyone should be benefited with quality and quantity water. Around 97 percent of water is held in oceans, while 3 percent is fresh water. Moreover, freshwater is not evenly distributed across land surfaces, and there are number of heavily populated countries where fresh water is scarce.

On other hand, concrete industry consumes large amount of water in mixing of mortar, mixing of concrete and even in curing which otherwise can be used for drinking purpose. Construction industry is second largest industry in India which consumes major amount of water.

Waste water gets mixed with the surface water after discharging it from industries. It tends to reduce the quality of surface water which is sometimes get consumed by humans for drinking purpose. Bad quality of water may affect the health of human beings and aquatic life also.

Now a days, scarcity of water is becoming a worldwide problem. And some extra efforts should be taken to resolve this problem. So, use of waste water discharged from different types of industries or locations in construction industry may help to reduce the problem of scarcity of water. This work aims to explain how treated waste water can be used in construction industry and reduces the load on nature.

Waste water collected from dairy, car wash center, sewage treatment plant, etc. is used as 100 percent substitution while making concrete. Cubes are supposed to be tested against compression load on 7, 14 and 28 days by casting and curing it with water from oil industry. Three concrete cubes are supposed to be tested during each and every test. So, 9 cubes are prepared by using waste water substitution which are willing to be compared with 9 cubes which are prepared by using potable water.

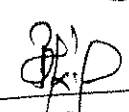

(II)

TRUE COPY

Principal
Vishwaniketan I.M.E.T.

Chapter 5

CONCLUSION

According to BIS, only potable water should be used for concrete to achieve the required strength. But various studies showed that treated waste water from various industries gives the required target strength to the concrete. According to Literature Review, treated waste water from car wash center, dairy, sewage treatment plant, etc. gives the strength more than concrete casted with potable water.

This research is done to check whether treated water from oil industry can be use in concrete or not. The concrete casted and cured with potable water gives strength to the concrete which is more than target mean strength. On the other hand, the concrete which is casted and cured with industrial waste water gave strength less than target mean strength but more than characteristic strength.

As results shows strength of concrete cube less than target mean strength but more than characteristic strength then we can say that water used in secondary concreting work can be replaced with treated industrial waste water. Secondary concreting works like PCC, Compound walls, etc.



TRUE COPY

Principal

“DYNAMIC ANALYSIS OF MULTISTORIED BUILDING WITH AND WITHOUT SHEAR WALL”

Submitted in partial fulfillment of the requirements of
the degree of
Bachelor of Engineering

By

Samiksha Patil(B-55)

Rutuja Patil(B-53)

Vinaya Patil(B-57)

Bhavna Pacharne(B-31)

Project Guide:

Prof. Pallavi Dongare



Department of Civil Engineering
Vishwaniketan's Institute of Management
Entrepreneurship and Engineering Technology, Khalapur

University of Mumbai

(2020-21)

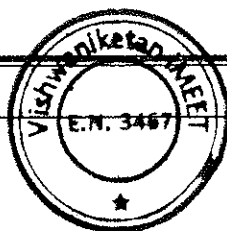

TRUE COPY

Page 1



Principal
Vishwaniketan's (i MEET)

CERTIFICATE

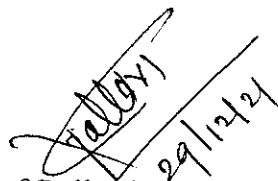
This is to certify that the project entitled "**Dynamic Analysis of Multistoried Building with And Without Shear Wall**" is a bonafide work of "**Samiksha Patil(B-55), Rutuja Patil(B-53), Vinaya Patil(B-57), Bhavna Pacharne(B-31)**" submitted to the University of Mumbai in partial fulfillment of the requirement for the award of the degree of "**Undergraduate**" in "**Civil Engineering**".

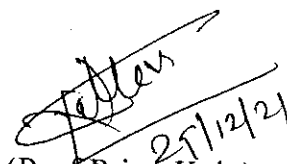
(Prof. Pallavi Dongare)
Project Guide

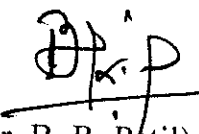

(Prof. Priya Kale)
Project Co-Guide

(Prof. Shilpa Deshpande)
Head of Department

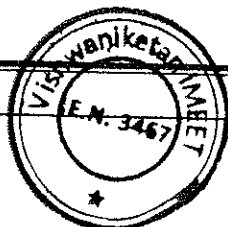
(Dr. B. R. Patil)
Principal

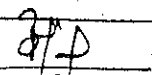

TRUE COPY

Principal
Vishwaniketan's (U.S.)

APPROVAL SHEET

Project Report Approval for B.E

This project report entitled "**Dynamic Analysis of Multistoried Building with And Without Shear WALL**" by SAMIKSHA PATIL, RUTUJA PATIL, VINAYA PATIL, BHAVNA PACHARNE is approved for the degree of "Bachelor of Engineering" in "Civil Engineering" from "Mumbai University".

Examiners

1. 

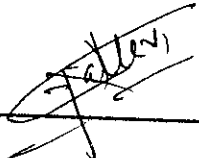
2. 

Date:

Place:

TRUE COPY

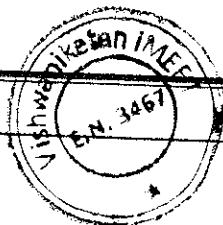

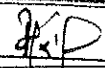
Principal
Vishwaniketan's (I IMET)

Abstract

In the seismic design of building, understand the effect of position of shear wall on behavior of RC structures. In this paper focus on, 25 storey building have been modeled using software ETABS-2015 by dynamic analysis. Shear walls are structural systems which provide stability to structures from lateral loads. All the analyses have been carried out as per Indian Standard code books. Based on the literature of previous studies effective positioning of shear walls have been chosen. This study is done on multistory building with and without shear wall. Dynamic responses under zone III, India earthquake, as per IS1893(Part 1):2016 and on type of soil is medium have been carried out. Response Spectrum Method is carried out for the results are computed based on storey displacement, storey drift, base shear and time period. Considering the multistoried building, three types of model. Building without shear wall, building with shear wall at middle core, building with shear wall at corners shows the best performance on effective position of shear wall.

Keywords: Dynamic analysis, shear wall, ETABS, Response Spectrum Method etc.



TRUE COPY

Principal Page 6
Vishwaniketan's (IMET)

Chapter VII

Conclusion

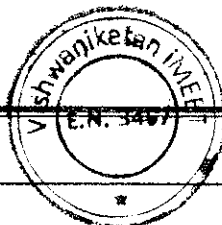

TRUE COPY

Page 42

Principal

Vishwaniketan's (i MEET)

This study reveals that the storey displacement, drift, base shear, time period and the overall seismic response of the structure is affected by the arrangements of shear wall. From numerical results of the present study, the following conclusions may be drawn:

1. In high rise structure, serviceability (displacement and drift) become equally important as that of strength and adding shear wall as central core in bare model displacement is reduced by 6.66 % which clearly shows how shear wall is important.
2. After addition of shear wall as central core in bare model, considerable reduction in time period from 2.44 sec to 1.738sec is achieved, this shows the benefit of using shear wall as central core in high rise structure, which is used for installing lifts in the structure.
3. Positioning and the shape of shear walls do not show much difference on base shear but base shear increases with addition of shear wall as stiffness increase.
4. As per analysis, it is concluded that the deflection at different level in multistoried building with shear wall is comparatively lesser as compared to RC building without shear wall.

Hence, we can conclude that building with shear wall shows results in term of storey displacement, storey drift, base shear and time period etc. at the same time considering shear all position corners perform better under seismic load.



TRUE COPY

Page 43

Principal

Vishwaniketan's (i MEET)

MINI PROJECT PART-A

ON
LEAKAGE TREATMENT ON RCC STRUCTURE

MITTED IN PARTIAL FULFILLMENT OF THE REQUIREMENT FOR THE AWARD OF THE

CIVIL ENGINEERING,

SUBMITTED BY

IDDHANT KARDAK , RAJENDRA JADHAV , RAJESH KOHNURKAR, VISHAL KHADKE

GUIDE: PROF. DEEPAI BARAD

CONFERRED BY

UNIVERSITY OF MUMBAI



• **DEPARTMENT OF CIVIL ENGINEERING**

• **VISHWANIKETAN INSTITUTE OF ENGINEERING**

• **KUMBHVALI (2020-2021) 0202**



TRUE COPY

[Signature]
Principal
Vishwaniketan's (KUMHVALI)

**VISHWANIKETAN INSTITUTE OF MANAGEMENT
ENTREPRENEURSHIP AND ENGINEERING TECHNOLOGY
A PRESENTATION ON**

SUBMITTED BY:-

SIDDHANT KARDAK

UNDER THE GUIDANCE OF :-

PROF. DEEPALI BARAD

2020-2021

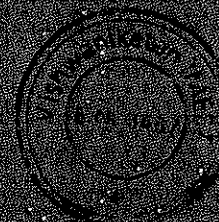

TRUE COPY

[Handwritten signature]
Principal

ACKNOWLEDGEMENTS

THIS IS NOT INCLUDED ONLY TO COMPLETE THE FORMALITIES AS PER TRADITION BECAUSE EVERYTHING IS IMPORTANT IN LIFE, CAN BE ACHIEVED ONLY AS A RESULT OF TEAM WORK OR COLLECTIVE EFFORTS PERSEVERANCE, INSPIRATION AND MOTIVATION HAVE ALWAYS PLAYED A KEY ROLE IN SUCCESS OF ANY VENTURE.

IT IS GREAT SENSE OF ACCOMPLISHMENT TO EXPRESS OUR SINCERE GRATITUDE TO OUR RESPECTED PROJECT GUIDE **PROF. DEEPALI BARAD** FOR THEIR CONSTANT INTEREST, ENCOURAGEMENT AND VALUABLE GUIDANCE DURING COMPLETION OF PROJECT.

WE WOULD LIKE TO EXTEND OUR GRATITUDE TO **PROF. DESHPANDE** HOD CIVIL ENGG DEPT. AND **DR. PATIL** PRINCIPAL WHO GAVE US VALUABLE SUGGESTION AND ALL THE REQUIRED FACILITIES TO PERFORM OUR PROJECT AND TO EVERYONE WHO IN THEIR OWN SPECIAL WAY HELPED US IN OUR PROJECT.

FINALLY WE EXPRESS OUR SINCERE THANKS TO ALL THOSE PEOPLE WHO OFFERED VALUABLE TIME, SUGGESTIONS AND ASSISTANCE DIRECTLY OR INDIRECTLY TO US TO ACHIEVE OUR AIM.

SUBMITTED BY-

- SIDDHANT KARDAK
- RAJENDRA JADHAV
- RAJESH KOHINURKAR
- VISHAL KHADE



TRUE COPY

Principal
Vishwara (11/11/2023)

INDEX

- **INTRODUCTION**
- **OBJECTIVES**
- **EFFECT OF LEAKAGE**
- **TESTING WATER LEAKAGE IN BUILDING**
- **CAUSES OF LEAKAGE**
- **LEAKAGE IN BUILDINGS AND REMEDIES**
- **MAINTENANCE FOR LEAKAGE**



TRUE COPY

Principal

Vishwanathar (C-1152)

INTRODUCTION

ONE OF THE BASIC REQUIREMENTS IN ALL BUILDINGS IS THAT THE STRUCTURE SHOULD REMAIN DRY AS FAR AS POSSIBLE. IF THIS CONDITION IS NOT ACHIEVED, THE BUILDING MAY BECOME UNHABITABLE AND UNSAFE FROM STRUCTURAL POINT OF VIEW. THE ENTRY OF WATER OR DAMPNESS INTO A BUILDING IS TERMED AS LEAKAGE.

LEAKAGE IN BUILDINGS IS COMMON AND IT IS IMPORTANT TO UNDERSTAND THE CAUSES AND MEASURES TO BE TAKEN FOR THEIR PREVENTION.

MOST OF THE BUILDING MATERIALS HAVING PORES IN THEIR STRUCTURE AS FOR EXAMPLE CONCRETE EXPAND ON ABSORBING MOISTURE FROM ATMOSPHERE AND SHRINK ON DRYING. THESE MOVEMENTS ARE REVERSIBLE.

AT CONDITION OF SATURATION LEAKAGE IN BUILDINGS OCCURS IN WALLS, FLAT ROOF, AND PARAPET WALL ETC.

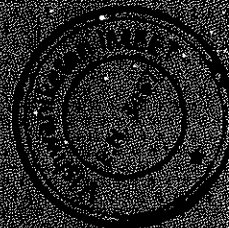

TRUE COPY

J.P.

www.ksars.org

OBJECTIVE

To upgrade Maintenance Technologies and Methodologies to achieve improvement in productivity and performance Of our buildings by applying Leakage Treatment .

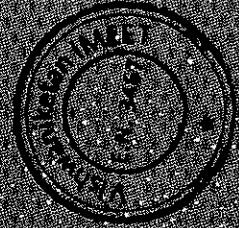

TRUE COPY

Principal
Vikraman (10000)

3. EFFECT OF LEAKAGE

The structure is badly affected by dampness. The prominent effect of dampness is as follows:

1. A damp building creates unhealthy conditions for those who occupy it (give a rise for breeding of mosquitoes).
2. The metals used in the construction of the building are corroded. Unsightly patches are formed on the wall surfaces and ceilings.
3. Decay of timber takes place rapidly due to dampness
4. The electric fittings are deteriorated due to dampness.
5. The material used as floor coverings are seriously damaged
6. softening and crumbling plasters
7. Wall decoration and paint damaged.
8. disintegration of the masonry and brick wall by dampness

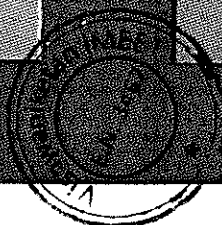
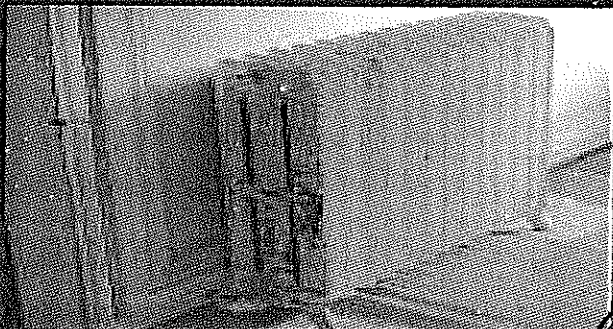

TRUE COPY

[Signature]
Vishwaniketan's (MEET)

TESTING WATER LEAKAGE IN BUILDING

ASTM E2128-01a, Standard Guide for Evaluating Water Leakage of Building Walls, published in January 2002 by ASTM International. This guide describes methods for determining and evaluating causes of water leakage of exterior walls.

This guide is intended to provide building professionals with a comprehensive methodology for evaluating water leakage through walls.

systematic approach to an evaluation

1. Review of project documents,
2. Evaluation of the wall's design concept
3. Determination of the building's service history
4. Inspection
5. Investigative testing,
6. Analysis, and
7. Report preparation

• TEST OPENING AT-

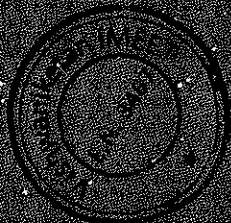
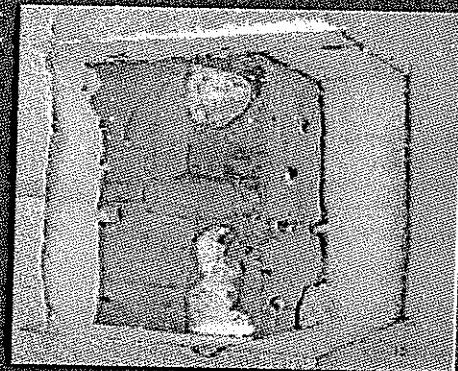

TRUE COPY

[Handwritten signature]

ASTM INTERNATIONAL'S (NET)

ASTM SPRAY RACK IN USE ON THE EXTERIOR OF AN ALUMINUM AND GLASS CURTAIN WALL

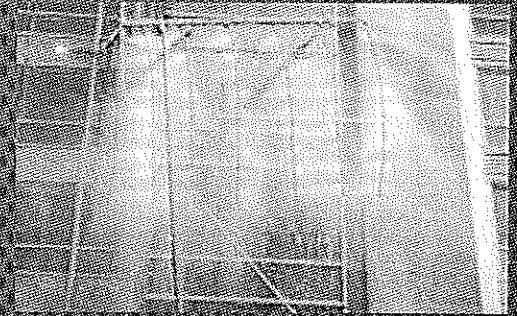

SPRAY RACK IN USE TO TEST THE INTERIOR SIDE OF A PARAPET WALL

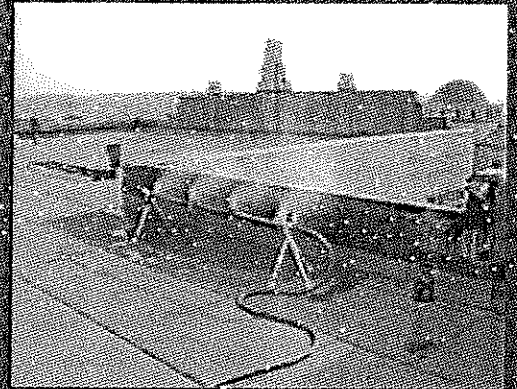

FIELD INSPECTION BY IR EQUIPMENTS

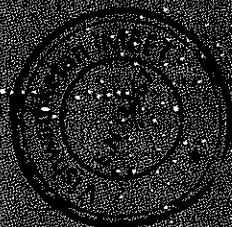
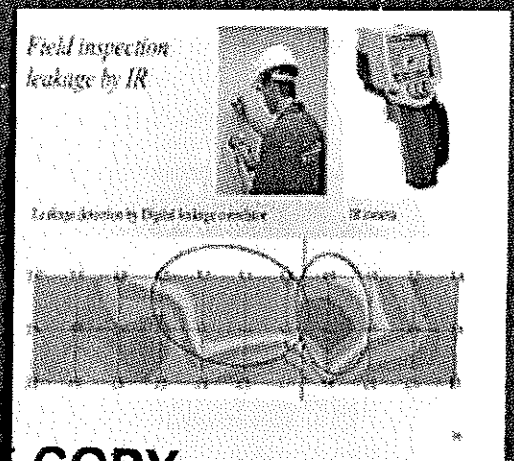

TRUE COPY

[Handwritten signature]

VIETNAM... (P)

MAN MADE LEAKAGE PROBLEMS-

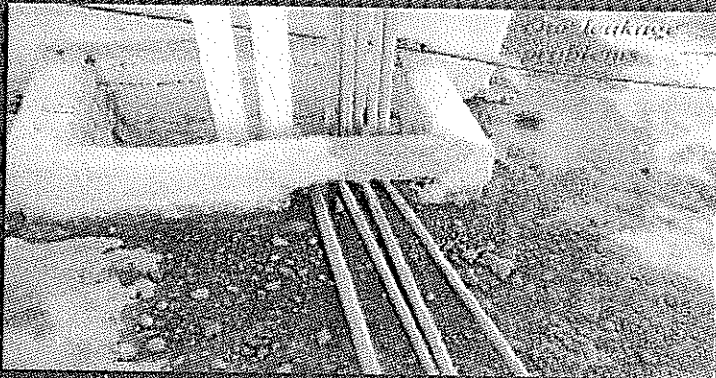

CAUSES OF LEAKAGE

1. Action of rainfall : If the faces of wall exposed to heavy showers of rain are not suitably protected, they become source of leakage in a structure. Similarly leakages from roofs also permit rainwater or drain water to enter in a structure ,Some times leakage from drain water cause settlement by washing the soil under foundations
2. Condensation: The moisture is deposited on the walls, ceilings etc. due to condensation process. Adequate ventilation is essential in any property for the wellbeing of the residents
3. Water storage in building



TRUE COPY

Principal
Vishwanathrao's & SONS

Water storage in buildings

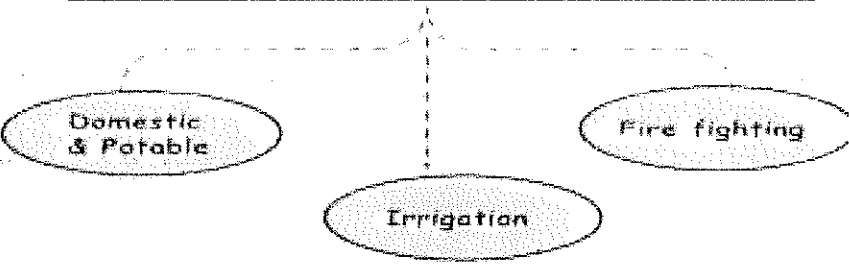

TRUE COPY

Principal
Vishwaniketan's (I ~~NET~~)



LEAKAGE IN BUILDING AND REMIDIES

- Leakage through roofs:

1. Lack of proper slope thereby causing stagnation of water (1.25%) Remedy: Adequate slope should be provided to prevent stagnation of water With expansion joint, clogged gutters is the most common cause of leakage, check to see if they are clean.
2. Lack of proper drainage system Remedy: Sufficient drainage pipes should be provided
3. Lack of coping of walls Remedy: coping on the top of the wall should be provided
4. Poor maintenance of water pipe connections and joints Remedy: Maintenance of water supply pipe connections and fitting should be leakproof.

- Leakage through walls

1. Lack of stone cladding/ waterproof and painting
2. Poor orientation and wind direction Natural ventilation
3. Lack of chajjas over openings

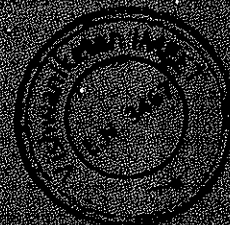
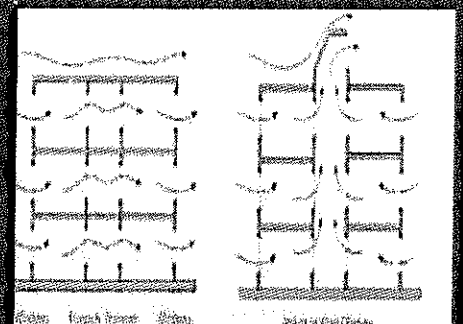

TRUE COPY

[Handwritten signature]
[Illegible handwritten text]

LEAKAGE FROM UPPER FLOOR

1. Crack in the closet and its trap or sewerage network Remedy: It should be replaced.
2. Leakage from the concealed pipe joints Remedy: It should be examined and replaced the same.

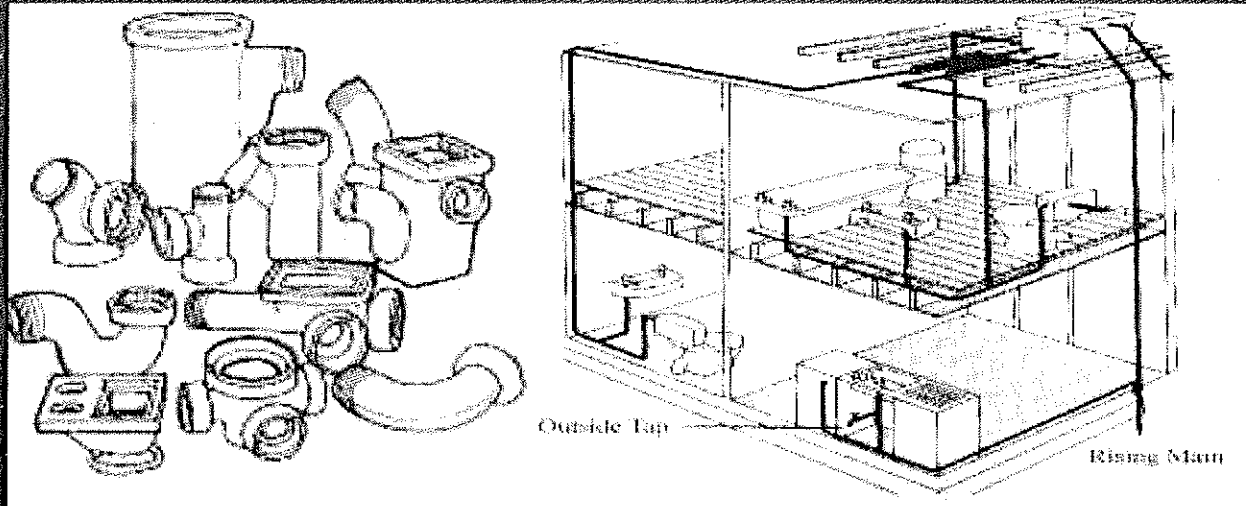

MAINTENANCE FOR PREVENTING LEAKAGE

1. Cleaning of terraces, drains before monsoon and when choked.
2. Replacement of leaky/damaged washers in fittings.
3. Replacement of leaky/damaged pipe line, gate valves, etc.
4. Replacement of leaky/damaged gasket in flanges.
5. Replacements of leaky/damaged joints in CI drain pipes.
6. Replacement of leaky/damaged MStrays under Air Handling Units



TRUE COPY

MATERIAL USED FOR DAMP PROOFING TYPES

1. Flexible material: Material like bitumen felts, plastic sheeting (Polythene sheet) etc.
2. Semi rigid materials: Materials like mastic asphalt or combination of materials or layers.
3. Rigid materials: Materials like first class bricks, stones, slates, cement concrete etc.
4. Grout consisting of cement slurry and acrylic based chemicals/polymers.

MATERIAL FOR DAMP PROOFING REQUIREMENT (SPECIFICATION)

1. It should be impermeable or should have very low permeability.
2. It should have strong adhesion with substrata.
3. It should be sufficiently elastic due to temperature fluctuations.
4. It should have high resistance of cracking.
5. It should be resistant to ultra violet rays.
6. It should be breathable i.e. permit vapor transmission.
7. Its application should be easy.
8. It should be durable.

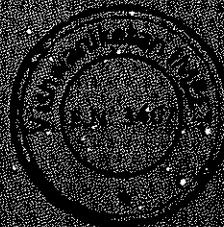

TRUE COPY

Principal
Government College (MCT)

COMMONLY USED MATERIALS FOR DAMP PROOFING.

- 1. Hot bitumen:** This is a flexible material and is placed on bedding of concrete or mortar. This material should be applied with a minimum thickness of 3 mm.
- 2. Mastic asphalt:** This is a semirigid material and it forms an excellent impervious layer for damp proofing. Good asphalt is a very durable and completely impervious material.
- 3. Stones:** two course of sound and dense stones as granites, slates, etc. laid in cement mortar with vertical breaking joints.
- 4. Bituminous felts:** isogam This is a flexible material. It is easy to lay and is available in rolls of normal wall width.
- 5. Metal sheets:** These sheets of lead, copper and aluminum can be used as membranes for damp proofing.
- 6. Combination of sheets and felts:** A lead foil is sandwiched between asphalt or bituminous felt. This is known as lead core and it is found to be economical, durable and efficient.
- 7. Mortar:** The mortar to be used for bedding layers 1:3. A small quantity of lime is added to increase the workability. For plastering work,
- 8. Bricks:** Dense bricks, absorbing water less than 4.5% of their weight, can be used for damp proofing.



TRUE COPY

Principal

Principal

THANK YOU

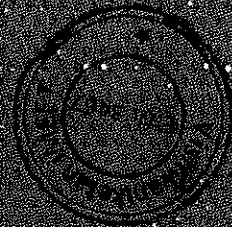

TRUE COPY

[Handwritten signature]

WINTERBURN & CO.



Vishwaniketan's

Institute of Management Entrepreneurship and Engineering Technology

Survey No-52 Off Mumbai-Pune Expressway Kumbhivali.

Tal- Khalapur, Maharashtra 410203.

Phone: (02192) 274206/274207/274208/274210

Sr No	Programme name	Program Code	List of students undertaking project wo. k/field work/internship	Title
1	Mechanical Engineering	346761210	Pinjari Prajyot Narayan	Internship
2	Mechanical Engineering	346761210	Ingale Onkar Laxman	Internship
3	Mechanical Engineering	346761210	Gharat Diptesh Chandrakant	Internship
4	Mechanical Engineering	346761210	Todkar Suraj Tanaji	Internship
5	Mechanical Engineering	346761210	Dalvi Mayuresh Sunil	Internship
6	Mechanical Engineering	346761210	Katke Kunal Nandkumar	Internship
7	Mechanical Engineering	346761210	Kambale Siddhant Sanjay	Internship
8	Mechanical Engineering	346761210	Kadu Yash Jitendra	Internship
9	Mechanical Engineering	346761210	Lagdhir Mayur Ramji	Internship
10	Mechanical Engineering	346761210	Patil Nikhil Rajendra	Internship
11	Mechanical Engineering	346761210	Shirke Mihir Rajendra	Internship
12	Mechanical Engineering	346761210	Gavade Omkar Santosh	Internship
13	Mechanical Engineering	346761210	Madhavi Sarvesh Santosh	Internship
14	Mechanical Engineering	346761210	Kate Mohan Dnyandev	Internship
15	Mechanical Engineering	346761210	Kurmi Vaibhav Shambhu	Internship
16	Mechanical Engineering	346761210	Pandey Piyush Ramsajivan	Internship
17	Mechanical Engineering	346761210	Karkare Ankit Ramesh	Internship
18	Mechanical Engineering	346761210	Mane Nikhil Suresh	Internship
19	Mechanical Engineering	346761210	Naik Sahil Umesh	Internship
20	Mechanical Engineering	346761210	Nangare Rahul Jitendra	Internship
21	Mechanical Engineering	346761210	Verma Nagendra Babulal	Internship
22	Mechanical Engineering	346761210	Dhumal Akash Arvind	Internship
23	Mechanical Engineering	346761210	Waghe Tanmay Anil	Internship
24	Mechanical Engineering	346761210	Mali Niraj Jijabrao	Internship
25	Mechanical Engineering	346761210	Abhiyash Manoj Patil	Internship
26	Mechanical Engineering	346761210	Siddhant Suresh Wavekar	Internship
27	Mechanical Engineering	346761210	Vedant Rajendra Mhatre	Internship

TRUE COPY



[Signature]
Principal
Vishwaniketan's (I MEET)

28	Mechanical Engineering	346761210	Pritesh S Pingale	Internship
29	Mechanical Engineering	346761210	Sanmesh S Shingrut	Internship
30	Mechanical Engineering	346761210	Mukesh Dashrath Bhoir	Internship
31	Mechanical Engineering	346761210	Nishant Balkrishna Patil	Internship
32	Mechanical Engineering	346761210	Saurabh S salvi	Internship
33	Mechanical Engineering	346761210	Salunke Ashish Ashok	Internship
34	Mechanical Engineering	346761210	Barday Tabish Ishaque Heena	Internship
35	Mechanical Engineering	346761210	Datar Aditya Uday	Internship
36	Mechanical Engineering	346761210	GIRI ROHIT PRAKASH	Internship
37	Mechanical Engineering	346761210	Himanshu Pralhad Choudhary	Internship
38	Mechanical Engineering	346761210	Modak Gaurav Chandrakant Chaitali	Internship
39	Mechanical Engineering	346761210	Hrishikesh Sandipan Pawar	Internship
40	Mechanical Engineering	346761210	Jignesh Anil Ghosalkar	Internship
41	Mechanical Engineering	346761210	KARJIKAR ARFAZ MOHAMMAD HANIF	Internship
42	Mechanical Engineering	346761210	Kushawa Abhishek Rambadal	Internship
43	Mechanical Engineering	346761210	MALI RUSHIKESH RAVINDRA	Internship
44	Mechanical Engineering	346761210	Manish Sharma	Internship
45	Mechanical Engineering	346761210	Patil Manish	Internship
46	Mechanical Engineering	346761210	Patle Kshitij	Internship
47	Mechanical Engineering	346761210	Pingale Manish Shyam	Internship
48	Mechanical Engineering	346761210	Pol Tushar Yuvraj	Internship
49	Mechanical Engineering	346761210	Prathamesh Pandurang Chogale	Internship
50	Mechanical Engineering	346761210	Pratik Suryavanshi	Internship
51	Mechanical Engineering	346761210	Pritesh Pingale	Internship
52	Mechanical Engineering	346761210	Punit Jayavant Jagtap	Internship
53	Mechanical Engineering	346761210	Ramkrishna Bhat	Internship
54	Mechanical Engineering	346761210	RANE RUSHIKESH	Internship
55	Mechanical Engineering	346761210	Sahil Dinesh Gaikwad	Internship
56	Mechanical Engineering	346761210	Saransh Yogendra Sachan	Internship
57	Mechanical Engineering	346761210	Sarvesh Ramesh Surve	Internship
58	Mechanical Engineering	346761210	Saurabh Sunil Pawar	Internship



TRUE COPY

[Signature]
Principal
Visnwaniketan's (i) MBET

59	Mechanical Engineering	346761210	Shardul Shekhar Gatare	Internship
60	Mechanical Engineering	346761210	Shivkumar B kumbhar	Internship
61	Mechanical Engineering	346761210	Shubham Bhavke	Internship
62	Mechanical Engineering	346761210	Siddhesh Bharat Shirke	Internship
63	Mechanical Engineering	346761210	Soham Amol Raut	Internship
64	Mechanical Engineering	346761210	Sorte Akshata Ashok	Internship
65	Mechanical Engineering	346761210	Suyog Kishor Mhatre	Internship
66	Mechanical Engineering	346761210	Tejasvi Sharad Patil	Internship
67	Mechanical Engineering	346761210	Tushar Yuvraj Pol	Internship
68	Mechanical Engineering	346761210	UTEKAR NIKHIL SUNIL	Internship
69	Mechanical Engineering	346761210	Vinit Chogale	Internship
70	Mechanical Engineering	346761210	Yash Santosh Deshmukh	Internship
71	Mechanical Engineering	346761210	Pandey Shashank Arun Kumar	Project Work
72	Mechanical Engineering	346761210	Nande Atharva Manoj	Project Work
73	Mechanical Engineering	346761210	Wairagade Mahesh Prabhakar	Project Work
74	Mechanical Engineering	346761210	/Gaikwad Mrunal Narendra	Project Work
75	Mechanical Engineering	346761210	Gaikwad Jay Prafull	Project Work
76	Mechanical Engineering	346761210	/Gharat Aarti Vishwanath	Project Work
77	Mechanical Engineering	346761210	Patil Bhavesh Hemant	Project Work
78	Mechanical Engineering	346761210	Autade Vishwajeet (pro)	Project Work
79	Mechanical Engineering	346761210	Pable Sukhjeetsingh Avtarsingh	Project Work
80	Mechanical Engineering	346761210	Gajre Abhishek Amrut	Project Work
81	Mechanical Engineering	346761210	Bangar Vikas Arjun	Project Work
82	Mechanical Engineering	346761210	Dharane Dipesh Ashok	Project Work
83	Mechanical Engineering	346761210	Kanu Reshma Nandkishor	Project Work
84	Mechanical Engineering	346761210	Khandekar Tushar Rajaram	Project Work
85	Mechanical Engineering	346761210	Mokal Amit Vilas	Project Work
86	Mechanical Engineering	346761210	Mokal Sahil Kamalakar	Project Work
87	Mechanical Engineering	346761210	Pawar Shubham Vishal	Project Work
88	Mechanical Engineering	346761210	Pawar Kunal Mohan	Project Work
89	Mechanical Engineering	346761210	Vitkar Atharva Prasad	Project Work



TRUE COPY

[Signature]
Principal
Vishwaniketan's (I) MBET

90	Mechanical Engineering	346761210	Singh Ankit Sarvesh Neelam	Project Work
91	Mechanical Engineering	346761210	/Sorate Akshata Ashok	Project Work
92	Mechanical Engineering	346761210	/Langi Samiksha Yogesh Ujwala	Project Work
93	Mechanical Engineering	346761210	More Sonal Haribhau	Project Work
94	Mechanical Engineering	346761210	More Ajinkya Amol	Project Work
95	Mechanical Engineering	346761210	Patil Aditya Kantilal	Project Work
96	Mechanical Engineering	346761210	Bagul Harshal Eknath	Project Work
97	Mechanical Engineering	346761210	Narvekar Shreemay Sanjay	Project Work
98	Mechanical Engineering	346761210	Patil Devendra Dattaram	Project Work
99	Mechanical Engineering	346761210	Sardal Rutvik Arun	Project Work
100	Mechanical Engineering	346761210	Rane Omkar Anil	Project Work
101	Mechanical Engineering	346761210	Rode Onkar Hanumant	Project Work
102	Mechanical Engineering	346761210	Pol Tushar Yuvraj	Project Work
103	Mechanical Engineering	346761210	Ghadage Utkarsh Madhukar	Project Work
104	Mechanical Engineering	346761210	Kokane Omkar Someshwar	Project Work
105	Mechanical Engineering	346761210	Shirke Siddhesh Bharat	Project Work
106	Mechanical Engineering	346761210	Hegiste Bhushan Shrikant	Project Work
107	Mechanical Engineering	346761210	Gharat Pushpak Rajesh	Project Work
108	Mechanical Engineering	346761210	Deshmukh Nikhil Uday	Project Work
109	Mechanical Engineering	346761210	Bhusari Apurv Vishnu	Project Work
110	Mechanical Engineering	346761210	Chandorkar Soham Atul	Project Work
111	Mechanical Engineering	346761210	Patil Tanmay Revannath	Project Work
112	Mechanical Engineering	346761210	Shelke Rushikesh Dattaram	Project Work
113	Mechanical Engineering	346761210	Patil Prashant Shesherao	Project Work
114	Mechanical Engineering	346761210	Patil Tushmesh Laxman	Project Work
115	Mechanical Engineering	346761210	Choudhary Suraj Kedar Prasad	Project Work
116	Mechanical Engineering	346761210	Barua Abhishek Ranjit Jayita	Project Work
117	Mechanical Engineering	346761210	Mhatre Kunal Shashikant	Project Work
118	Mechanical Engineering	346761210	Chandel Satejsingh Mahendrasineh	Project Work
119	Mechanical Engineering	346761210	Chavan Vishwajit Satish	Project Work
120	Mechanical Engineering	346761210	Bhawke Omkar Bajarang	Project Work



TRUE COPY

[Signature]
Principal
Vishwaniketan's (i) MBET

121	Mechanical Engineering	346761210	Shinde Rohit Ramchandra	Project Work
122	Mechanical Engineering	346761210	Jadhav Rohit Bapuso	Project Work
123	Mechanical Engineering	346761210	Sale Shreyas Sanjay	Project Work
124	Mechanical Engineering	346761210	Deshmukh Sanket Suresh	Project Work
125	Mechanical Engineering	346761210	Ghole Dakshet Suresh	Project Work
126	Mechanical Engineering	346761210	Dudhbhate Suraj Khandu	Project Work
127	Mechanical Engineering	346761210	Barve Akash Satyvan	Project Work
128	Mechanical Engineering	346761210	Andhale Aniket Sampat	Project Work
129	Mechanical Engineering	346761210	Nangare Shivam Ramdas	Project Work
130	Mechanical Engineering	346761210	Bhaytandel Aniket Chandrakant	Project Work
131	Mechanical Engineering	346761210	Jangam Omkar Vijaykumar	Project Work
132	Mechanical Engineering	346761210	Koli Omkar Chandrakant	Project Work
133	Mechanical Engineering	346761210	Kamble Aniket Balu	Project Work
134	Mechanical Engineering	346761210	Mohite Ajinkya Ramchandra (pro)	Project Work
135	Mechanical Engineering	346761210	Sakpal Mihir Vijay (pro)	Project Work
136	Mechanical Engineering	346761210	Gaikwad Sahil Sanjay	Project Work
137	Mechanical Engineering	346761210	Patil Yash Sanjay	Project Work
138	Mechanical Engineering	346761210	Jadhav Avinash Balkrishan	Project Work
139	Mechanical Engineering	346761210	Gharat Sarvesh Shivdas	Project Work
140	Mechanical Engineering	346761210	Raut Abhijeet Mahadev	Project Work
141	Mechanical Engineering	346761210	Patil Harishchandra Suresh	Project Work
142	Mechanical Engineering	346761210	Patil Umesh Shrikrishna	Project Work
143	Mechanical Engineering	346761210	Kulkarni Shreerang Pramod	Project Work
144	Mechanical Engineering	346761210	Khedekar Shubham Raosaheb	Project Work
145	Mechanical Engineering	346761210	Bhosale Omkar Shankar	Project Work
146	Mechanical Engineering	346761210	Arke Sagar Bhausaheb	Project Work
147	Mechanical Engineering	346761210	Jain Shubham Parasmai	Project Work
148	Mechanical Engineering	346761210	Shende Sagar Sopan	Project Work
149	Mechanical Engineering	346761210	Mhatre Nitesh Mukund	Project Work
150	Mechanical Engineering	346761210	Khandale Ravindra Birappa	Project Work
151	Mechanical Engineering	346761210	Vishwakarma Sourabh Dwipchand	Project Work



TRUE COPY

J.P.
Principal
Vishwaniketan's (i MEET)

152	Mechanical Engineering	346761210	Kamat Shanknil Satish	Project Work
153	Mechanical Engineering	346761210	Mhatre Pratik Prakash	Project Work
154	Mechanical Engineering	346761210	Salunke Rohit Narayan	Project Work
155	Mechanical Engineering	346761210	Patil Manish Anil	Project Work
156	Mechanical Engineering	346761210	Sawant Saurabh Subhash	Project Work
157	Mechanical Engineering	346761210	Shaikh Samir Jamil	Project Work
158	Mechanical Engineering	346761210	Shinde Prathamesh Suresh	Project Work
159	Mechanical Engineering	346761210	Thakur Pritesh Jeevan	Project Work
160	Mechanical Engineering	346761210	Sherkar Shubham Sambhaji	Project Work
161	Mechanical Engineering	346761210	Shelke Tushar Vilas	Project Work
162	Mechanical Engineering	346761210	Shirsat Pranal Avadhut	Project Work
163	Mechanical Engineering	346761210	Suryawanshi Nikhil Sunil	Project Work
164	Mechanical Engineering	346761210	Vishwakarma Shivam Shriram	Project Work
165	Mechanical Engineering	346761210	Shinde Darshan Bharat	Project Work
166	Mechanical Engineering	346761210	Kamble Sumedh Baliram	Project Work
167	Mechanical Engineering	346761210	Salavi Saurabh Sandip	Project Work
168	Mechanical Engineering	346761210	Sawant Aditya Avinash	Project Work
169	Mechanical Engineering	346761210	Ausarmal Ajit Atmaram (pro)	Project Work
170	Mechanical Engineering	346761210	Chougule Akshay Bapurao	Project Work
171	Mechanical Engineering	346761210	Radhakrishnan Anirudha (pro)	Project Work
172	Mechanical Engineering	346761210	Maske Buddhbhusan Santosh (pro)	Project Work
173	Mechanical Engineering	346761210	Khairnar Harshal Amrut	Project Work
174	Mechanical Engineering	346761210	Mahadik Aniket Baliram (pro)	Project Work
175	Mechanical Engineering	346761210	Ghosalkar Paresh Prakash	Project Work
176	Mechanical Engineering	346761210	Vhore Shyamsundar Keshav (pro)	Project Work
177	Mechanical Engineering	346761210	Pawar Dilip Arun	Project Work
178	Mechanical Engineering	346761210	Shinde Sarvesh Tulshidas	Project Work
179	Mechanical Engineering	346761210	Zore Chandu Babu	Project Work
180	Mechanical Engineering	346761210	Patil Prathamesh Pradeep	Project Work
181	Mechanical Engineering	346761210	Pawar Akash Anil	Project Work
182	Mechanical Engineering	346761210	Patil Vinit Abhimanyu	Project Work



TRUE COPY

[Signature]
Principal
Vishwaniketan's (I) MBET

183	Mechanical Engineering	346761210	Jadhav Gaurav Chhotulal	Project Work
184	Mechanical Engineering	346761210	Gharat Abhijit Ramchandra	Project Work
185	Mechanical Engineering	346761210	Ugale Vaibhav Vishnu	Project Work
186	Mechanical Engineering	346761210	Lendave Suyash Siddheshwar	Project Work
187	Mechanical Engineering	346761210	Atkari Tejas Sanjay	Project Work
188	Mechanical Engineering	346761210	Singh Sahil Pratap	Project Work
189	Mechanical Engineering	346761210	Patil Hrutik Kishor	Project Work
190	Mechanical Engineering	346761210	Mhatre Pratik Janardan	Project Work
191	Mechanical Engineering	346761210	Patil Suraj Dhanaji	Project Work
192	Mechanical Engineering	346761210	Mokal Nandan Anil	Project Work
193	Mechanical Engineering	346761210	Bhoir Rohan Hemant	Project Work
194	Mechanical Engineering	346761210	Mali Sahil Sharad	Project Work
195	Mechanical Engineering	346761210	Mhatre Kunal Baliram	Project Work
196	Mechanical Engineering	346761210	Mhatre Mrunai Krishna	Project Work
197	Mechanical Engineering	346761210	Fakke Akash Rajendra	Project Work
198	Mechanical Engineering	346761210	Dalvi Kunal Ravindra	Project Work
199	Mechanical Engineering	346761210	Deshmukh Sahil Dinesh	Project Work
200	Mechanical Engineering	346761210	Joshi Rutik Prabhakar	Project Work
201	Mechanical Engineering	346761210	Patil Manthan Santosh	Project Work
202	Mechanical Engineering	346761210	Bhagat Akshay Anandkumar	Project Work
203	Mechanical Engineering	346761210	Tandei Amey Anant	Project Work
204	Mechanical Engineering	346761210	Nadkar Shubham Ramesh	Project Work
205	Mechanical Engineering	346761210	Omitya Mokal	Project Work
206	Mechanical Engineering	346761210	dipesh Patil	Project Work
207	Mechanical Engineering	346761210	Shubham Patil	Project Work
208	Mechanical Engineering	346761210	Vedant Patil	Project Work
209	Mechanical Engineering	346761210	Prathmesh Mhatre	Project Work
210	Mechanical Engineering	346761210	Shreyog Bhesare	Project Work
211	Mechanical Engineering	346761210	Rohan Ghadge	Project Work
212	Mechanical Engineering	346761210	Shayan Khan	Project Work
213	Mechanical Engineering	346761210	Shreyash Daware	Project Work

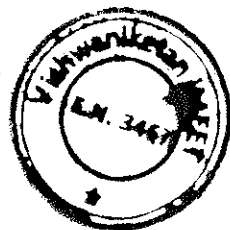

TRUE COPY

[Signature]
Principal
Vishwaniketan's (I) MEET

214	Mechanical Engineering	346761210	Shrey Dhanorkar	Project Work
215	Mechanical Engineering	346761210	Sairaj Patil	Project Work
216	Mechanical Engineering	346761210	Sachin Kakade	Project Work
217	Mechanical Engineering	346761210	Dalvi Rhutik	Project Work
218	Mechanical Engineering	346761210	Pratapure Ajinkya	Project Work
219	Mechanical Engineering	346761210	Deshmukh Yash	Project Work
220	Mechanical Engineering	346761210	Fernandes Wilson	Project Work
221	Mechanical Engineering	346761210	Jeevan Chalke	Project Work
222	Mechanical Engineering	346761210	Makarand Tandel	Project Work
223	Mechanical Engineering	346761210	Prajakta Chile	Project Work
224	Mechanical Engineering	346761210	Smita Kamble	Project Work
225	Mechanical Engineering	346761210	Mali Vivek	Project Work
226	Mechanical Engineering	346761210	Gavand Shubham	Project Work
227	Mechanical Engineering	346761210	Bhagat Sohan	Project Work
228	Mechanical Engineering	346761210	Chatare Tejas	Project Work
229	Mechanical Engineering	346761210	Khan Taufique	Project Work
230	Mechanical Engineering	346761210	Gharat Chaitanya	Project Work
231	Mechanical Engineering	346761210	Vealaskar Suraj	Project Work
232	Mechanical Engineering	346761210	Patil Amey	Project Work
233	Mechanical Engineering	346761210	Phanse Sarangkumar	Project Work
234	Mechanical Engineering	346761210	Prasad Sharadkumar	Project Work
235	Mechanical Engineering	346761210	Nikam Prasad	Project Work
236	Mechanical Engineering	346761210	Shelar Dipanshu	Project Work
237	Mechanical Engineering	346761210	Sakpal Rutik Madhukar	Project Work
238	Mechanical Engineering	346761210	Zanzane Raj Vikas	Project Work
239	Mechanical Engineering	346761210	Zalte Akshay Raju	Project Work
240	Mechanical Engineering	346761210	Chorge Yash Rajesh	Project Work
241	Mechanical Engineering	346761210	Chavan Shreyas Deepak	Project Work
242	Mechanical Engineering	346761210	Mahadik Sakshi Bharat	Project Work
243	Mechanical Engineering	346761210	Mhatre Swagat Shashikant	Project Work
244	Mechanical Engineering	346761210	Waghulkar Yash Santosh	Project Work



TRUE COPY

[Signature]
Principal
Vishwaniketan's (I MBET)

245	Mechanical Engineering	346761210	Mhatre Devesh Dasharath	Project Work
246	Mechanical Engineering	346761210	Patil Omkar Pradip	Project Work
247	Mechanical Engineering	346761210	Mhatre Pritam Shamkant	Project Work
248	Mechanical Engineering	346761210	Wavekar Prathamesh Mahesh	Project Work
249	Mechanical Engineering	346761210	Patil Shreyas Shashikant	Project Work
250	Mechanical Engineering	346761210	Patil Shubham Suresh	Project Work
251	Mechanical Engineering	346761210	Mhatre Sushmita Dayanand	Project Work
252	Mechanical Engineering	346761210	More Rohit Ramesh	Project Work
253	Mechanical Engineering	346761210	Bhatkar Sahil Ashish	Project Work
254	Mechanical Engineering	346761210	Degaonkar Aniket Arvind	Project Work
255	Mechanical Engineering	346761210	Deshmukh Omkar Pralhad	Project Work
256	Mechanical Engineering	346761210	Gade Sanket Ramesh	Project Work
257	Mechanical Engineering	346761210	Gaikwad Omkar Dattatray	Project Work
258	Mechanical Engineering	346761210	Kamble Prathamesh Sunil	Project Work
259	Mechanical Engineering	346761210	Khopade Omkar Shekhar	Project Work
260	Mechanical Engineering	346761210	Kumbhar Raturaj Bajarang	Project Work
261	Mechanical Engineering	346761210	Mhatre Pranay Prabhakar	Project Work
262	Mechanical Engineering	346761210	Nale Akash Dadasaheb	Project Work
263	Mechanical Engineering	346761210	Pandav Rahul Rajendra	Project Work
264	Mechanical Engineering	346761210	Parbalkar Asnil Baliram	Project Work
265	Mechanical Engineering	346761210	Pawar Chinmay Uddhav	Project Work
266	Mechanical Engineering	346761210	Pirakar Shailesh Ramchandra	Project Work
267	Mechanical Engineering	346761210	Sasane Amit Raju	Project Work
268	Mechanical Engineering	346761210	Thite Mihir Santosh	Project Work
269	Civil Engineering	346719110	Rushikesh A. Patil	Internship
270	Civil Engineering	346719110	Rahul Shankar Jadhav	Internship
271	Civil Engineering	346719110	Rutuja Nandgaonkar	Internship
272	Civil Engineering	346719110	Sanjana S. Patil	Internship
273	Civil Engineering	346719110	Vivek Sunil Kamble	Internship
274	Civil Engineering	346719110	Vaibhavi Sunil Misal	Internship
275	Civil Engineering	346719110	Rajkumar Sunil Yadav	Internship



TRUE COPY

[Signature]
Principal
Vishwaniketan's (i) MEET

276	Civil Engineering	346719110	Pranay Sanjay Ghasti	Internship
277	Civil Engineering	346719110	Abhijeet Sopan Gaikawad	Internship
278	Civil Engineering	346719110	Pranav Vilas Mhatre	Internship
279	Civil Engineering	346719110	Vijay Sunil Sawant	Internship
280	Civil Engineering	346719110	Roshani Suresh Madake	Internship
281	Civil Engineering	346719110	Sachin Tanaji Bugade	Internship
282	Civil Engineering	346719110	Abhay Vithoba Shirsat	Internship
283	Civil Engineering	346719110	Dhembre Prathmesh Appasaheb	Internship
284	Civil Engineering	346719110	Virulkar Dhanshri Ishwar	Internship
285	Civil Engineering	346719110	Khade Mayuri	Internship
286	Civil Engineering	346719110	Suraj Arun Maharnur	Internship
287	Civil Engineering	346719110	Ketan Babasaheb Waghule	Internship
288	Civil Engineering	346719110	Saurabh Shigvan	Internship
289	Civil Engineering	346719110	Prakash Shinde	Internship
290	Civil Engineering	346719110	Vikas Chavan	Internship
291	Civil Engineering	346719110	Nishita Mhatre	Internship
292	Civil Engineering	346719110	Gitanjali Patil	Internship
293	Civil Engineering	346719110	Sahilee Patil	Internship
294	Civil Engineering	346719110	Sanjana Patil	Internship
295	Civil Engineering	346719110	Rutuja Nandgaonkar	Internship
296	Civil Engineering	346719110	Sarthak Bais	Internship
297	Civil Engineering	346719110	Prathamesh Kulkarni	Internship
298	Civil Engineering	346719110	Tejas Mhatre	Internship
299	Civil Engineering	346719110	Rahul Jadhav	Internship
300	Civil Engineering	346719110	Vishal Belote	Internship
301	Civil Engineering	346719110	Kapil Patil	Internship
302	Civil Engineering	346719110	Dayanand Subhash	Internship
303	Civil Engineering	346719110	Rutik Narvekar	Internship
304	Civil Engineering	346719110	SAITAWADEKAR SAURABH RAMESH	Internship
305	Civil Engineering	346719110	THAKUR ABHISHEK ANIL	Internship
306	Civil Engineering	346719110	MHATRE NISHANT CHANDRASHEKHAR	Internship



TRUE COPY

[Signature]
Principal
Vishwaniketan's (I) MEET

307	Civil Engineering	346719110	KIRAN MAHALE	Internship
308	Civil Engineering	346719110	RUSHABH PAREKH	Internship
309	Civil Engineering	346719110	KALYAN PATIL	Internship
310	Civil Engineering	346719110	VAIBHAV THAKUR	Internship
311	Civil Engineering	346719110	CHAVAN VIKAS	Internship
312	Civil Engineering	346719110	PANDHARE RUSHIKESH	Internship
313	Civil Engineering	346719110	PATIL SAYALI	Internship
314	Civil Engineering	346719110	CHAVARE TANVI	Internship
315	Civil Engineering	346719110	SHETTE RIDDHI	Internship
316	Civil Engineering	346719110	KAMBLE ANKUR	Internship
317	Civil Engineering	346719110	PANDEY NEERAJ	Internship
318	Civil Engineering	346719110	WARGE YASH	Internship
319	Civil Engineering	346719110	SOY ANAND	Internship
320	Civil Engineering	346719110	PATIL PRITIKA	Internship
321	Civil Engineering	346719110	PATIL SAMIKSHA	Internship
322	Civil Engineering	346719110	PADWAL SOHAN	Internship
323	Civil Engineering	346719110	BEDSE JAYESH	Internship
324	Civil Engineering	346719110	MASANE KAPIL MANGAL	Internship
325	Civil Engineering	346719110	Nikhil Dandekar	Internship
326	Civil Engineering	346719110	Laukik salekar	Internship
327	Civil Engineering	346719110	Sushant Thamboli	Internship
328	Civil Engineering	346719110	Omkar Dhanawade	Internship
329	Civil Engineering	346719110	Ritesh J Damare	Internship
330	Civil Engineering	346719110	Omkar N. Gardi	Internship
331	Civil Engineering	346719110	Shivani A. Jadhav	Internship
332	Civil Engineering	346719110	Akshay R. Jadhav	Internship
333	Civil Engineering	346719110	Nikhil K Jadhav	Internship
334	Civil Engineering	346719110	Ganesh S. Kor	Internship
335	Civil Engineering	346719110	Hrushikesh Gosavi	Internship
336	Civil Engineering	346719110	Prathmesh appasaheb dhembre	Internship
337	Civil Engineering	346719110	Sayali anil patil	Internship



TRUE COPY

Principal
Vishwaniketan's (i) MBET

338	Civil Engineering	346719110	Megha Dinkar Bhujbal	Internship
339	Civil Engineering	346719110	Divya D. Gawand	Internship
340	Civil Engineering	346719110	aditya mhatre	Internship
341	Civil Engineering	346719110	akshay salunke	Internship
342	Civil Engineering	346719110	tejas inkar	Internship
343	Civil Engineering	346719110	ankur kamble	Internship
344	Civil Engineering	346719110	MHATRE TEJAS HEMANT	Internship
345	Civil Engineering	346719110	VIRULKAR DHANSHRI ISHWAR	Internship
346	Civil Engineering	346719110	DALVI NINAD NAMDEO	Project Work
347	Civil Engineering	346719110	NARVEKAR RUTIK ADIK	Project Work
348	Civil Engineering	346719110	MHATRE CHIRAYU JAHINDRANATH	Project Work
349	Civil Engineering	346719110	PATIL KALYAN PRALHAD	Project Work
350	Civil Engineering	346719110	THAKUR SURAJ BHARAT	Project Work
351	Civil Engineering	346719110	PATIL PRITIKA KIRIT	Project Work
352	Civil Engineering	346719110	PATIL PAYAL KISHOR	Project Work
353	Civil Engineering	346719110	WAGHULE KETAN BABASAHEB	Project Work
354	Civil Engineering	346719110	GHAVATE RAJ ANIL	Project Work
355	Civil Engineering	346719110	T HIRTHICKBHARANI S TAMILVANAN	Project Work
356	Civil Engineering	346719110	PATIL SAMIKSHA HANUMAN	Project Work
357	Civil Engineering	346719110	PATIL RUTUJA ARUN	Project Work
358	Civil Engineering	346719110	PATIL VINAYA MADAN	Project Work
359	Civil Engineering	346719110	PACHARNE BHAVNA NANASAHEB	Project Work
360	Civil Engineering	346719110	PAL SHUBHAM YASHWANT	Project Work
361	Civil Engineering	346719110	QUREISHI NOORUDDIN AHMED	Project Work
362	Civil Engineering	346719110	SAYYED HASAN AHMED	Project Work
363	Civil Engineering	346719110	GADADE SHUBHAM BIRUDEO	Project Work
364	Civil Engineering	346719110	GHASTI PRANAY SANJAY	Project Work
365	Civil Engineering	346719110	DAYANAND SUBHASH INDUBAI	Project Work
366	Civil Engineering	346719110	KHEDKAR AKSHAY ANAND	Project Work
367	Civil Engineering	346719110	NARONA H. SHASHIKANT	Project Work
368	Civil Engineering	346719110	SALUNKE ABHISHEK GANESH	Project Work

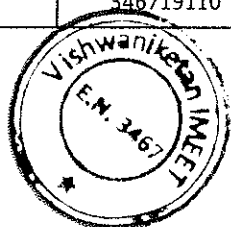

TRUE COPY

[Signature]
Principal
Vishwaniketan's (I) MEET

369	Civil Engineering	346719110	CHAVHAN SWARAJ VISHWAS	Project Work
370	Civil Engineering	346719110	KABURE GAJANAN APPASO	Project Work
371	Civil Engineering	346719110	BELOTE VISHAL PAPPU	Project Work
372	Civil Engineering	346719110	CHAUDHARY SHEFALI HEMANT	Project Work
373	Civil Engineering	346719110	DHEMBRE PRATHMESH APPASAHEB	Project Work
374	Civil Engineering	346719110	KHADE MAYURI DATTATRAY	Project Work
375	Civil Engineering	346719110	BHAGAT SARVESH JAGDISH	Project Work
376	Civil Engineering	346719110	DESHMUKH SHUBHAM SANJAY	Project Work
377	Civil Engineering	346719110	CHOUDHARI DARSHAN ANIL	Project Work
378	Civil Engineering	346719110	KAMBLE VIVEK SUNIL	Project Work
379	Civil Engineering	346719110	BATHIJA KUNAL R.	Project Work
380	Civil Engineering	346719110	DANDEKAR NIKHIL JAYENDRA	Project Work
381	Civil Engineering	346719110	FERNANDES ALVES	Project Work
382	Civil Engineering	346719110	KUMAVAT KIRAN DAGA	Project Work
383	Civil Engineering	346719110	SOY ANAND NANDLAL	Project Work
384	Civil Engineering	346719110	PATIL RONAK SANJIVAN	Project Work
385	Civil Engineering	346719110	PAREKH RUSHABH MILAN	Project Work
386	Civil Engineering	346719110	PATEL VEENA DHANJI	Project Work
387	Civil Engineering	346719110	HAJARE VAIBHAV SURESH	Project Work
388	Civil Engineering	346719110	GURAV NIKHIL UDAY	Project Work
389	Civil Engineering	346719110	HANDE RUSHIKESH RAMCHANDRA	Project Work
390	Civil Engineering	346719110	GAWADE VAIBHAV SUBHASH	Project Work
391	Civil Engineering	346719110	PATIL SAHILEE PARSHURAM	Project Work
392	Civil Engineering	346719110	SHAIKH FAIYYAZ SAYYAD	Project Work
393	Civil Engineering	346719110	SHAIKH SAAD ARSHAD	Project Work
394	Civil Engineering	346719110	WARKE SHWETA SUDHAKAR	Project Work
395	Civil Engineering	346719110	MHATRE PRATIKESH SHANKAR	Project Work
396	Civil Engineering	346719110	MAHADIK ADITYA KASHINATH	Project Work
397	Civil Engineering	346719110	MANDAVKAR MANSI SUDHAKAR	Project Work
398	Civil Engineering	346719110	NAIK KETAN PADAJI	Project Work
399	Civil Engineering	346719110	MHATRE PRANAV VILAS	Project Work

TRUE COPY



[Signature]
Principal
Vishwaniketan's (I) MEET

400	Civil Engineering	346719110	NANDGAONKAR RUTUJA SANTOSH	Project Work
401	Civil Engineering	346719110	WANALEKAR VARSHA HANUMANTRAO	Project Work
402	Civil Engineering	346719110	MULLA SAJADA SHAFAHATAHAMAD	Project Work
403	Civil Engineering	346719110	KUMAVAT KARAN ANAND	Project Work
404	Civil Engineering	346719110	NIVALE BALKRUSHNA LAXMAN	Project Work
405	Civil Engineering	346719110	KHANDALKAR ADITYA BALKRISHNA	Project Work
406	Civil Engineering	346719110	PAWAR ASHUTOSH SHIVAJI	Project Work
407	Civil Engineering	346719110	KATRODIA MITANSHU MANISH	Project Work
408	Civil Engineering	346719110	KOLEKAR PRATIK NAMDEO	Project Work
409	Civil Engineering	346719110	ACHARYA VARUN GANPAT	Project Work
410	Civil Engineering	346719110	PATRIKAR SHASHWAT VINOD	Project Work
411	Civil Engineering	346719110	PATIL PREETI SANTOSH	Project Work
412	Civil Engineering	346719110	GUJAR SHUBHAM ANIL	Project Work
413	Civil Engineering	346719110	PATIL PARAMVIR PANDURANG	Project Work
414	Civil Engineering	346719110	PATIL OMKAR SARYAKANT	Project Work
415	Civil Engineering	346719110	PUNYARTHI RUSHIKESH SADANAND	Project Work
416	Civil Engineering	346719110	BORKAR ADITYA PRADEEP	Project Work
417	Civil Engineering	346719110	MULEY PRANAY TEJRAO	Project Work
418	Civil Engineering	346719110	MHATRE NISHANT MANOHAR	Project Work
419	Civil Engineering	346719110	TEMBARE SIMRAN NANASAHEB	Project Work
420	Civil Engineering	346719110	GOSAVI HRUSHIKESH SHRIRAM	Project Work
421	Civil Engineering	346719110	THAKUR SAHIL MANOHAR	Project Work
422	Civil Engineering	346719110	SURVE CHAITANYA SANJAY	Project Work
423	Civil Engineering	346719110	GHADGE SANDESH RAJENDRA	Project Work
424	Civil Engineering	346719110	PAWAR SANJAY SOMA	Project Work
425	Civil Engineering	346719110	SHAIKH IJMAMUL JAKIR	Project Work
426	Civil Engineering	346719110	SAUNDALKAR AKSHAY SAKHARAM	Project Work
427	Civil Engineering	346719110	JADHAV SHIVRAJ SHAHAJI	Project Work
428	Civil Engineering	346719110	NIMBALKAR SUPRIYA GANPAT	Project Work
429	Civil Engineering	346719110	KHADAKBAN SUYOG VAIBHAV	Project Work
430	Civil Engineering	346719110	DEVYANI BARASKAR	Project Work



TRUE COPY

J.P.
Principal
Vishwaniketan's (I MEET)

431	Civil Engineering	346719110	MADAKE ROSHANI SURESH	Project Work
432	Civil Engineering	346719110	PATIL SANJANA SANDESH	Project Work
433	Civil Engineering	346719110	SAWANT VIJAY SUNIL	Project Work
434	Civil Engineering	346719110	PAWAR DHANANJAY DILIP	Project Work
435	Civil Engineering	346719110	GAVATE HITESH JANARDAN NILIMA	Project Work
436	Civil Engineering	346719110	GHADI NIKHIL PRAMOD	Project Work
437	Civil Engineering	346719110	JADHAV SARVESH SANDEEP	Project Work
438	Civil Engineering	346719110	DHUMAL GANESH RAJENDRA	Project Work
439	Civil Engineering	346719110	KHALOKAR SUSHANT AJAY	Project Work
440	Civil Engineering	346719110	DESHMUKH PRATHMESH NARESH	Project Work
441	Civil Engineering	346719110	PANDEY NEERAJ RAMCHANDRA	Project Work
442	Civil Engineering	346719110	PANDEY ARVIND RAMSAGAR	Project Work
443	Civil Engineering	346719110	DAMARE RITESH TANAJI	Project Work
444	Civil Engineering	346719110	JADHAV NIKHIL KAILAS	Project Work
445	Civil Engineering	346719110	DHAWALE GITANJLI GOVIND	Project Work
446	Civil Engineering	346719110	BEDSE JAYESH DIPAK	Project Work
447	Civil Engineering	346719110	BASARE SHRADDHA	Project Work
448	Civil Engineering	346719110	CHAVARE TANVI	Project Work
449	Civil Engineering	346719110	GURAO GAYATRI ANKUSH	Project Work
450	Civil Engineering	346719110	PATIL KAJAL DILIP	Project Work
451	Civil Engineering	346719110	GAWAND DIVYA DINANATH	Project Work
452	Civil Engineering	346719110	KOR GANESH SHANTARAM	Project Work
453	Civil Engineering	346719110	MOKAL MINAL JAYARAM	Project Work
454	Civil Engineering	346719110	MHATRE NISHITA YASHVANT	Project Work
455	Civil Engineering	346719110	BHUJBAL MEGHA DINKAR	Project Work
456	Civil Engineering	346719110	DESHMUKH ANKITA VIKAS	Project Work
457	Civil Engineering	346719110	BHORING SAGAR MANUBHAI	Project Work
458	Civil Engineering	346719110	GAIKWAD KALPESH LAXMAN	Project Work
459	Civil Engineering	346719110	GARDI OMKAR NARENDRA	Project Work
460	Civil Engineering	346719110	JADHAV RAHUL SHANKAR	Project Work
461	Civil Engineering	346719110	DHOKALE BALAJI DADASAHEB	Project Work



TRUE COPY

[Signature]
Principal
Vishwaniketan's (I MEEET)

462	Civil Engineering	346719110	BHAGAT DHAVAL DINESH	Project Work
463	Civil Engineering	346719110	JADHAV AKSHAY RAMESH	Project Work
464	Civil Engineering	346719110	JADHAV SHIVANI ANANT	Project Work
465	Civil Engineering	346719110	JOSHI SIDDHANT GANESH	Project Work
466	Civil Engineering	346719110	KOLAMBE TUSHAR BHAGWAN	Project Work
467	Civil Engineering	346719110	GHARAT VRUSHALI SHIRISH	Project Work
468	Civil Engineering	346719110	PATIL GITANJALI JAYAWANT	Project Work
469	Civil Engineering	346719110	PATIL AKASH GANESH	Project Work
470	Civil Engineering	346719110	MHATRE RAHUL ASHOK	Project Work
471	Civil Engineering	346719110	AHIRRAO SNEHA RAJARAM	Project Work
472	Civil Engineering	346719110	GHARAT DIWANGI MANOJ	Project Work
473	Civil Engineering	346719110	WAGHMARE ANKITA ASHOK	Project Work
474	Civil Engineering	346719110	GAIKWAD ANKITA ASHOK	Project Work
475	Civil Engineering	346719110	TAMBOLI SUSHANT MADHUKAR	Project Work
476	Civil Engineering	346719110	SALEKAR LAUKIK BHARAT	Project Work
477	Civil Engineering	346719110	TAMBADE GOPINATH RAJENDRA	Project Work
478	Civil Engineering	346719110	PAWAR OMKAR	Project Work
479	Civil Engineering	346719110	WAGH SAURABH MADHUKAR	Project Work
480	Civil Engineering	346719110	KOTIWALE AVISHKAR IRAPPA	Project Work
481	Civil Engineering	346719110	KACHARE VIVEK	Project Work
482	Civil Engineering	346719110	MHATRE TEJASVI	Project Work
483	Civil Engineering	346719110	JAIWAR PRANSHU RAMLAL	Project Work
484	Civil Engineering	346719110	KHARATMOL SAGAR PANDURANG	Project Work
485	Civil Engineering	346719110	BHAGAT PRANAY	Project Work
486	Civil Engineering	346719110	MAHANUR SURAJ	Project Work
487	Civil Engineering	346719110	KARANJKAR AKASH RAJEBHAU	Project Work
488	Civil Engineering	346719110	BUGADE SACHIN TANAJI	Project Work
489	Civil Engineering	346719110	JADHAV NILESH MURALI	Project Work
490	Civil Engineering	346719110	SHIRSAT ABHAY VITHOBA	Project Work
491	Civil Engineering	346719110	MHATRE SAMIR SANJAY	Project Work
492	Civil Engineering	346719110	SHETYE RIDDHI ASHISH MANSI	Project Work



TRUE COPY

[Signature]
Principal
Vishwaniketan's (I MBET)

493	Civil Engineering	346719110	SALAVI DARSHAN MANOHAR	Project Work
494	Civil Engineering	346719110	PATIL JAYESH MOHAN	Project Work
495	Civil Engineering	346719110	KOLEKAR AMOL JAGANNATH	Project Work
496	Civil Engineering	346719110	MANE PRASAD VIKAS	Project Work
497	Civil Engineering	346719110	PAWAR CHAITANYA MILIND	Project Work
498	Civil Engineering	346719110	KODAG AKASH GORAKH	Project Work
499	Civil Engineering	346719110	KARDE SHUBHAM PRAKASH	Project Work
500	Civil Engineering	346719110	BHAT WASEEM	Project Work
501	Civil Engineering	346719110	MAHALE KIRAN HARISH	Project Work
502	Civil Engineering	346719110	MASKE VIKAS	Project Work
503	Civil Engineering	346719110	GAWALI PRASHANT ARJUN	Project Work
504	Civil Engineering	346719110	YADAV ANIKET MAHENDRA	Project Work
505	Civil Engineering	346719110	JADHAV RAJKUMAR SUNIL	Project Work
506	Civil Engineering	346719110	JAGDALE SAGAR	Project Work
507	Civil Engineering	346719110	JEURGI PRATIK	Project Work
508	Civil Engineering	346719110	GAIKWAD SARTHAK	Project Work
509	Civil Engineering	346719110	AMANE PRADYUMN	Project Work
510	Civil Engineering	346719110	PARDESHI RUSHIKESH	Project Work
511	Civil Engineering	346719110	INARKAR ANKUSH	Project Work
512	Civil Engineering	346719110	PANDHARE AKSHAY	Project Work
513	Civil Engineering	346719110	KUNDALE SWAPNIL	Project Work
514	Civil Engineering	346719110	SHINDE NIKHIL	Project Work
515	Civil Engineering	346719110	MOTE TEJAS	Project Work
516	Civil Engineering	346719110	MHATRE ADITYA	Project Work
517	Civil Engineering	346719110	KAMBLE ANKUR	Project Work
518	Civil Engineering	346719110	MASANE KAPIL	Project Work
519	Civil Engineering	346719110	THAKUR VAIBHAV	Project Work
520	Civil Engineering	346719110	MALKAR ROHIT	Project Work
521	Civil Engineering	346719110	PATIL TUSHAR	Project Work
522	Civil Engineering	346719110	YADAV NIRANJAN	Project Work
523	Civil Engineering	346719110	PANDIT ADITYA DAYANAND	Project Work



TRUE COPY

[Signature]
Principal
Vishwaniketan's (I MEET)

524	Civil Engineering	346719110	POOJARY SAMANTH SUDHAKAR	Project Work
525	Civil Engineering	346719110	PALVE NITESH GANGARAM	Project Work
526	Civil Engineering	346719110	GHARAT ANVAY RAVINDRA	Project Work
527	Civil Engineering	346719110	PATIL ABHIRAJ MAHENDRA	Project Work
528	Civil Engineering	346719110	MHATRE DARSHAN MANOHAR	Project Work
529	Civil Engineering	346719110	MHATRE AAKASH GANGARAM	Project Work
530	Civil Engineering	346719110	MHATRE NITESH GANESH	Project Work
531	Civil Engineering	346719110	MORE AISHWARYA MILIND	Project Work
532	Civil Engineering	346719110	TERDE HIMANSHU PRAKASH	Project Work
533	Civil Engineering	346719110	DAREKAR PRATHAM ANIL	Project Work
534	Civil Engineering	346719110	PAWAR RUTUJA RAJENDRA	Project Work
535	Civil Engineering	346719110	SHIRKE JAYESH RAMDAS	Project Work
536	Civil Engineering	346719110	JADHAV SURAJ VENKAT	Project Work
537	Civil Engineering	346719110	AVHAD DNYANESHWAR DIGAMBAR	Project Work
538	Civil Engineering	346719110	SURYAVANSHI PRATHMESH SHIVAJI	Project Work
539	Civil Engineering	346719110	SORATHIA ALFAIEZ IQBAL	Project Work
540	Civil Engineering	346719110	KAMBLE SIDDHIRAJ GAUTAM	Project Work
541	Civil Engineering	346719110	THORAT TANMAY	Project Work
542	Civil Engineering	346719110	ABDAR SWAPNIL DEVIDAS	Project Work
543	Civil Engineering	346719110	AMBEKAR ROHIT SURESH	Project Work
544	Civil Engineering	346719110	BADE AVINASH VIJAY	Project Work
545	Civil Engineering	346719110	BHILARE SIDDHANT SANJAY	Project Work
546	Civil Engineering	346719110	BHOIR SANKET GANGARAM	Project Work
547	Civil Engineering	346719110	DHAMALE SUSHIL SUNIL	Project Work
548	Civil Engineering	346719110	GAIKWAD AKASH VASANT	Project Work
549	Civil Engineering	346719110	GAIKWAD RHEA SUNIL	Project Work
550	Civil Engineering	346719110	GAVAND TANMAY KESHVINATH	Project Work
551	Civil Engineering	346719110	GAWAND DURVAL GAJANAN	Project Work
552	Civil Engineering	346719110	GUPTA RAJESH UTTAM	Project Work
553	Civil Engineering	346719110	JADHAV ANAND DILIP	Project Work
554	Civil Engineering	346719110	JADHAV ANIKET DEVRAM	Project Work

TRUE COPY



[Signature]
Principal
Vishwaniketan's (I) MEET

555	Civil Engineering	346719110	JADHAV RAJENDRA PANDURANG	Project Work
556	Civil Engineering	346719110	KARDAK SIDDHANT SHYAM	Project Work
557	Civil Engineering	346719110	KHADE VISHAL BALIRAM	Project Work
558	Civil Engineering	346719110	KOHINOORKAR RAJESH DEVINDRA	Project Work
559	Civil Engineering	346719110	LIGAM AAKASH CHANDRAKANT	Project Work
560	Civil Engineering	346719110	MHATRE ANIKET CHANDRAKANT	Project Work
561	Civil Engineering	346719110	MUNDHE KSHITIJ BHARAT	Project Work
562	Civil Engineering	346719110	PALKAR AKSHAY KAILAS	Project Work
563	Civil Engineering	346719110	PALRECHA PRAJWAL INDARAMAL	Project Work
564	Civil Engineering	346719110	PATIL KALPESH PRABHAKAR	Project Work
565	Civil Engineering	346719110	PATIL SHRUTEESUDHAKAR	Project Work
566	Civil Engineering	346719110	PAWAR PRANAV GIRISH	Project Work
567	Civil Engineering	346719110	PINGALA PRIYANKA KRUSHNA	Project Work
568	Civil Engineering	346719110	SATVE YASH CHANDRAKANT	Project Work
569	Civil Engineering	346719110	SHID MAHESH RAMESH	Project Work
570	Civil Engineering	346719110	TALKAR SURAJ SUDHAKAR	Project Work
571	Civil Engineering	346719110	UGHADA NANA KAMALU	Project Work
572	Civil Engineering	346719110	GADAGE DEEPAK KONDIBA	Project Work
573	Civil Engineering	346719110	BIRADAR ABHIJEET SHANTKUMAR	Project Work
574	Civil Engineering	346719110	SANKPAL GAURAV SANTOSH	Project Work
575	Electrical Engineering	346729310	Sonali Khopkar	Internship
576	Electrical Engineering	346729310	Deshmukh Saurab	Internship
577	Electrical Engineering	346729310	Tanmay Khandekar	Internship
578	Electrical Engineering	346729310	Sandesh Nimbale	Internship
579	Electrical Engineering	346729310	Preshit Ghadge	Internship
580	Electrical Engineering	346729310	Prathmesh Mhatre	Internship
581	Electrical Engineering	346729310	Anuja ladge	Internship
582	Electrical Engineering	346729310	Vijay Shivaji Gaikwad	Internship
583	Electrical Engineering	346729310	Ravi kumar Gupta	Internship
584	Electrical Engineering	346729310	Aniket Shirke	Internship
585	Electrical Engineering	346729310	Jay Gaikar	Internship

TRUE COPY



[Signature]
Principal
Vishwaniketan's (I MEET)

586	Electrical Engineering	346729310	Divyesh Koli	Internship
587	Electrical Engineering	346729310	Aditya Shingare	Internship
588	Electrical Engineering	346729310	Saurab Deshmukh	Internship
589	Electrical Engineering	346729310	Sidheish Deepak Borrse	Internship
590	Electrical Engineering	346729310	Soham Salunkhe	Internship
591	Electrical Engineering	346729310	Bangar Akash Arjun	Project Work
592	Electrical Engineering	346729310	Bendre Aniket Pratap	Project Work
593	Electrical Engineering	346729310	Bhagat Anushka Vinod	Project Work
594	Electrical Engineering	346729310	Bhoir Narayan Pundlik	Project Work
595	Electrical Engineering	346729310	Chakraborty Nishant	Project Work
596	Electrical Engineering	346729310	Chavan Omkar Laxman	Project Work
597	Electrical Engineering	346729310	Choudhari Sayali Sunil	Project Work
598	Electrical Engineering	346729310	Dahimbekar Tejal Anil	Project Work
599	Electrical Engineering	346729310	Dale Rohan Rajesh	Project Work
600	Electrical Engineering	346729310	Dalvi Sayali Ramesh	Project Work
601	Electrical Engineering	346729310	Darekar Avinash Subhash	Project Work
602	Electrical Engineering	346729310	Deshmukh Tushar Vijay	Project Work
603	Electrical Engineering	346729310	Dhapate Swapnil Chandrasen	Project Work
604	Electrical Engineering	346729310	Dhuri Yogita Kamalakar	Project Work
605	Electrical Engineering	346729310	Dube Rashika Vilas	Project Work
606	Electrical Engineering	346729310	Gaikwad Vijay Shivaji	Project Work
607	Electrical Engineering	346729310	Ghanvat Amit Maruti	Project Work
608	Electrical Engineering	346729310	Gharat Vinaya Sandesh	Project Work
609	Electrical Engineering	346729310	Ghorpade Abhijeet Sambhaji	Project Work
610	Electrical Engineering	346729310	Ghume Shreenivas Balaji	Project Work
611	Electrical Engineering	346729310	Goyal Pruthvi Shivram	Project Work
612	Electrical Engineering	346729310	Huke Supraj Subodh	Project Work
613	Electrical Engineering	346729310	Jadhav Mayur Manoj	Project Work
614	Electrical Engineering	346729310	Jadhav Omkar Maruti	Project Work
615	Electrical Engineering	346729310	Jadhav Suraj Sunil	Project Work
616	Electrical Engineering	346729310	Joshi Shruti Sudhir	Project Work



TRUE COPY

J.P.
Principal
Vishwaniketan's (i) MBET

617	Electrical Engineering	346729310	Karde Yuvraj Bhalchandra	Project Work
618	Electrical Engineering	346729310	Kasare Sagar Dilip	Project Work
619	Electrical Engineering	346729310	Ladge Anuja Dhananjay	Project Work
620	Electrical Engineering	346729310	Landge Shraddha Bhaskar	Project Work
621	Electrical Engineering	346729310	Madan Pallavi Baburao	Project Work
622	Electrical Engineering	346729310	Mahato Krishna Sanat	Project Work
623	Electrical Engineering	346729310	Mali Harshali Prabhakar	Project Work
624	Electrical Engineering	346729310	Mhatre Diksha Mahadev	Project Work
625	Electrical Engineering	346729310	Mhatre Siddhesh Devidas	Project Work
626	Electrical Engineering	346729310	Mishra Karunanand Manoj	Project Work
627	Electrical Engineering	346729310	Mokal Nishant Krishna	Project Work
628	Electrical Engineering	346729310	Narayankar, Rishabh, Bhaskar	Project Work
629	Electrical Engineering	346729310	Nhavkar Niranjan Namdev	Project Work
630	Electrical Engineering	346729310	Ovhal Pratik Prabhakar	Project Work
631	Electrical Engineering	346729310	Padalkar Pratik Pandurang	Project Work
632	Electrical Engineering	346729310	Pandit Shreelesh	Project Work
633	Electrical Engineering	346729310	Parthe Vaibhav Vijay	Project Work
634	Electrical Engineering	346729310	Pathare Darshan Suresh	Project Work
635	Electrical Engineering	346729310	Patil Ajay Dilip	Project Work
636	Electrical Engineering	346729310	Patil Asmit Kailas	Project Work
637	Electrical Engineering	346729310	Patil Harshal Sadanand	Project Work
638	Electrical Engineering	346729310	Patil Jayesh Sanjay	Project Work
639	Electrical Engineering	346729310	Patil Mahendra Chhotulal	Project Work
640	Electrical Engineering	346729310	Patil Nayan Gopinath	Project Work
641	Electrical Engineering	346729310	Patil Nihar Sanjay	Project Work
642	Electrical Engineering	346729310	Patil Sahil Sopan	Project Work
643	Electrical Engineering	346729310	Patil Shraddha Ramesh	Project Work
644	Electrical Engineering	346729310	Patil Shubham Haribhau	Project Work
645	Electrical Engineering	346729310	Patil Siddhesh Kesarinath	Project Work
646	Electrical Engineering	346729310	Patil Vishant Devidas	Project Work
647	Electrical Engineering	346729310	Pawar Nitesh	Project Work



TRUE COPY

[Signature]
Principal
Vishwaniketan's (i MEET)

648	Electrical Engineering	346729310	Phadke Ameya Anand	Project Work
649	Electrical Engineering	346729310	Sable Omkar Pravin	Project Work
650	Electrical Engineering	346729310	Salunkhe Suraj Subhash	Project Work
651	Electrical Engineering	346729310	Salunkhe Tejas Hanumant	Project Work
652	Electrical Engineering	346729310	Shelke Ravi Kanu	Project Work
653	Electrical Engineering	346729310	Shirke Kalpesh Ankrish	Project Work
654	Electrical Engineering	346729310	Sutar Nikhil Kishor	Project Work
655	Electrical Engineering	346729310	Sutar Shubham Shashikant	Project Work
656	Electrical Engineering	346729310	Tandel Pankaj Dhanaji	Project Work
657	Electrical Engineering	346729310	Taru Amey Ravindra	Project Work
658	Electrical Engineering	346729310	Thakur Akhil Vidyadhar	Project Work
659	Electrical Engineering	346729310	Thakur Bhavana Dhanaji	Project Work
660	Electrical Engineering	346729310	Thakur Rahul Ramesh	Project Work
661	Electrical Engineering	346729310	Thale Shreyas Shrikant	Project Work
662	Electrical Engineering	346729310	Thale Tejal Vikas	Project Work
663	Electrical Engineering	346729310	Todankar Vipresh Digambar	Project Work
664	Electrical Engineering	346729310	Toraskar Tejashri Dasharath	Project Work
665	Electrical Engineering	346729310	Tupe Bhagyashree Kashinath	Project Work
666	Electrical Engineering	346729310	Ubhare Shreya Sanjay	Project Work
667	Electrical Engineering	346729310	Vaghare Swagat Manohar	Project Work
668	Electrical Engineering	346729310	Vartak Akash Kishor	Project Work
669	Electrical Engineering	346729310	Wadal Paras Dattatrey	Project Work
670	Electrical Engineering	346729310	Wasave Suraj Bhima	Project Work
671	Electrical Engineering	346729310	Adagale Rugved Mugutrao Usha	Project Work
672	Electrical Engineering	346729310	Balkawade Deep Sandeep Shweta	Project Work
673	Electrical Engineering	346729310	Bangal Jagruti Santosh Simantini	Project Work
674	Electrical Engineering	346729310	Bhagat Ajinkya Mohan Mohini	Project Work
675	Electrical Engineering	346729310	Bhoir Sanchit Bhaskar Sangita	Project Work
676	Electrical Engineering	346729310	Bhosale Abhishek Harishchandra Manda	Project Work
677	Electrical Engineering	346729310	Bhosale Aniruddha Pratap Manasi	Project Work
678	Electrical Engineering	346729310	Borrse Sidheish Deepak Suvarna	Project Work



TRUE COPY

[Signature]
Principal
Vishwaniketan's (I) MBET

679	Electrical Engineering	346729310	Chaulkar Rohit Vilas Shweta	Project Work
680	Electrical Engineering	346729310	Dalvi Nayan Nagesh Surekha	Project Work
681	Electrical Engineering	346729310	Ghodvinde Rohan Sunil Rekha	Project Work
682	Electrical Engineering	346729310	Gopale Pravin Kisan Nutan	Project Work
683	Electrical Engineering	346729310	Jadhav Ashish Anand Asha	Project Work
684	Electrical Engineering	346729310	Jambekar Kunal Madhukar Mamata	Project Work
685	Electrical Engineering	346729310	Kamble Rohan Deepak Reshma	Project Work
686	Electrical Engineering	346729310	Kende Vaishali Bhau Lilam	Project Work
687	Electrical Engineering	346729310	Khaire Aniket Arvind Ankita	Project Work
688	Electrical Engineering	346729310	Kulkarni Mrunmayee Sanjay Vijaya	Project Work
689	Electrical Engineering	346729310	Lokhande Rajratna Yashavant Vijaya	Project Work
690	Electrical Engineering	346729310	Mali Anurag Sanjiv Anita	Project Work
691	Electrical Engineering	346729310	Manchekar Pratik Chandrakant Chaitali	Project Work
692	Electrical Engineering	346729310	Mhatre Geeta Vishwanath Vijaya	Project Work
693	Electrical Engineering	346729310	Mhatre Kaustubh Jitendra Vijaya	Project Work
694	Electrical Engineering	346729310	Mhatre Pravin Vishnu Sarita	Project Work
695	Electrical Engineering	346729310	Mishra Aditya Anup Archana	Project Work
696	Electrical Engineering	346729310	Mokal Mayur Mohan Manisha	Project Work
697	Electrical Engineering	346729310	Nadkar Roshan Santosh Manisha	Project Work
698	Electrical Engineering	346729310	Nagaonkar Prathamesh Kishor Karuna	Project Work
699	Electrical Engineering	346729310	Nivate Roshan Gangaram Gitanjali	Project Work
700	Electrical Engineering	346729310	Patil Dipesh Haridas Revati	Project Work
701	Electrical Engineering	346729310	Patil Pratik Sunil Varsha	Project Work
702	Electrical Engineering	346729310	Patil Vishal Prabhakar Sujata	Project Work
703	Electrical Engineering	346729310	Patil Yash Sunil Sarika	Project Work
704	Electrical Engineering	346729310	Pawar Vivek Vitthal Bharati	Project Work
705	Electrical Engineering	346729310	Pingale Rahul Ramesh Kalpana	Project Work
706	Electrical Engineering	346729310	Raut Aditya Vishwas Asha	Project Work
707	Electrical Engineering	346729310	Raut Vaibhav Tanaji Lata	Project Work
708	Electrical Engineering	346729310	Sajekar Tejas Anil Anita	Project Work
709	Electrical Engineering	346729310	Shaikh Sufiya Munaf Naeema	Project Work



TRUE COPY

[Signature]
Principal
Vishwaniketan's (i) MBET

710	Electrical Engineering	346729310	Shinde Shreyas Rajesh Rashmi	Project Work
711	Electrical Engineering	346729310	Singh Divyam Sanjay Ritu	Project Work
712	Electrical Engineering	346729310	Singh Sachinkumar Akhileshprasad Lalitadevi	Project Work
713	Electrical Engineering	346729310	Singh Sarani Arvind Renu	Project Work
714	Electrical Engineering	346729310	Thakare Prathamesh Dinesh Lata	Project Work
715	Electrical Engineering	346729310	Thakare Prem Ganesh Manisha	Project Work
716	Electrical Engineering	346729310	Thakur Aditya Ajit Arati	Project Work
717	Electrical Engineering	346729310	Waghmare Mayuri Bibhishan Chhababai	Project Work
718	Electrical Engineering	346729310	Yadav Suraj Arun Sonam	Project Work
719	Electrical Engineering	346729310	Yede Pawan Pandit Savita	Project Work
720	Electrical Engineering	346729310	Zore Sandip Sayaji Banabai	Project Work
721	Electronics and Telecommunication Engineering	346737210	Ashish Ahire Nitin	Internship
722	Electronics and Telecommunication Engineering	346737210	Pingale Kedar sunil	Internship
723	Electronics and Telecommunication Engineering	346737210	Bhosale Kiran Sanjeev	Internship
724	Electronics and Telecommunication Engineering	346737210	Mane Pratiksha Ajit	Internship
725	Electronics and Telecommunication Engineering	346737210	Daksh Maan Kushalpal	Internship
726	Electronics and Telecommunication Engineering	346737210	Patil Vineet Vasant	Internship
727	Electronics and Telecommunication Engineering	346737210	Mokal Swagat Anil	Internship
728	Electronics and Telecommunication Engineering	346737210	Mhatre Rupali Shailesh	Internship
729	Electronics and Telecommunication Engineering	346737210	Nemade Gaurav Santosh	Internship
730	Electronics and Telecommunication Engineering	346737210	Sonawale Ajinkya Subhash	Internship
731	Electronics and Telecommunication Engineering	346737210	Bhopi Mayuresh Mohan	Internship
732	Electronics and Telecommunication Engineering	346737210	Deshmukh Rutuja Kishor	Internship
733	Electronics and Telecommunication Engineering	346737210	More Pratiksha Dilip	Internship
734	Electronics and Telecommunication Engineering	346737210	Deshmukh Shweta sunil	Internship
735	Electronics and Telecommunication Engineering	346737210	Pandit Sandesh Prakash	Internship
736	Electronics and Telecommunication Engineering	346737210	Thakare Tejasvi Ganesh	Internship
737	Electronics and Telecommunication Engineering	346737210	Kumbhar Kunal Shashikant	Internship
738	Electronics and Telecommunication Engineering	346737210	Thombare Shraddha Gajendra	Internship
739	Electronics and Telecommunication Engineering	346737210	Lote Mansi Vinayak	Internship
740	Electronics and Telecommunication Engineering	346737210	Bhosale Dhanashree Manohar	Internship

TRUE COPY



[Signature]
Principal
Vishwaniketan's (i MEET)

741	Electronics and Telecommunication Engineering	346737210	More Nihar Sandeep	Internship
742	Electronics and Telecommunication Engineering	346737210	Daswadkar Milind Janardan	Internship
743	Electronics and Telecommunication Engineering	346737210	Bhalerao Shubham sanjay	Internship
744	Electronics and Telecommunication Engineering	346737210	Sutar Sharvari Kishor	Internship
745	Electronics and Telecommunication Engineering	346737210	Pawar Sanket Babu	Internship
746	Electronics and Telecommunication Engineering	346737210	Kadam Omkar Arvind	Internship
747	Electronics and Telecommunication Engineering	346737210	Patil Nikita Babasaheb	Internship
748	Electronics and Telecommunication Engineering	346737210	Shahane Sakshi Atul	Internship
749	Electronics and Telecommunication Engineering	346737210	Patil Jaydip Prakash	Internship
750	Electronics and Telecommunication Engineering	346737210	Ashish Ahire Nitin	Internship
751	Electronics and Telecommunication Engineering	346737210	Pingale Kedar sunil	Internship
752	Electronics and Telecommunication Engineering	346737210	Bhosale Kiran Sanjeev	Internship
753	Electronics and Telecommunication Engineering	346737210	Mane Pratiksha Ajit	Internship
754	Electronics and Telecommunication Engineering	346737210	Daksh Maan Kushalpal	Internship
755	Electronics and Telecommunication Engineering	346737210	Patil Vineet Vasant	Internship
756	Electronics and Telecommunication Engineering	346737210	Mokal Swagat Anil	Internship
757	Electronics and Telecommunication Engineering	346737210	Mhatre Rupali Shailesh	Internship
758	Electronics and Telecommunication Engineering	346737210	Nemade Gaurav Santosh	Internship
759	Electronics and Telecommunication Engineering	346737210	Sonawale Ajinkya Subhash	Internship
760	Electronics and Telecommunication Engineering	346737210	Bhopi Mayuresh Mohan	Internship
761	Electronics and Telecommunication Engineering	346737210	Deshmukh Rutuja Kishor	Internship
762	Electronics and Telecommunication Engineering	346737210	More Pratiksha Dilip	Internship
763	Electronics and Telecommunication Engineering	346737210	Deshmukh Shweta sunil	Internship
764	Electronics and Telecommunication Engineering	346737210	Pandit Sandesh Prakash	Internship
765	Electronics and Telecommunication Engineering	346737210	Thakare Tejasvi Ganesh	Internship
766	Electronics and Telecommunication Engineering	346737210	Kumbhar Kunal Shashikant	Internship
767	Electronics and Telecommunication Engineering	346737210	Thombare Shraddha Gajendra	Internship
768	Electronics and Telecommunication Engineering	346737210	Lote Mansi Vinayak	Internship
769	Electronics and Telecommunication Engineering	346737210	Bhosale Dhanashree Manohar	Internship
770	Electronics and Telecommunication Engineering	346737210	More Nihar Sandeep	Internship
771	Electronics and Telecommunication Engineering	346737210	Daswadkar Milind Janardan	Internship

TRUE COPY



[Signature]
Principal
Vishwaniketan's (I MBET)

772	Electronics and Telecommunication Engineering	346737210	Bhalerao Shubham sanjay	Internship
773	Electronics and Telecommunication Engineering	346737210	Sutar Sharvari Kishor	Internship
774	Electronics and Telecommunication Engineering	346737210	Pawar Sanket Babu	Internship
775	Electronics and Telecommunication Engineering	346737210	Kadam Omkar Arvind	Internship
776	Electronics and Telecommunication Engineering	346737210	Patil Nikita Babasaheb	Internship
777	Electronics and Telecommunication Engineering	346737210	Shahane Sakshi Atul	Internship
778	Electronics and Telecommunication Engineering	346737210	Patil Jaydip Prakash	Internship
779	Electronics and Telecommunication Engineering	346737210	Abdul Farhan Abdul Karim Saman	Internship
780	Electronics and Telecommunication Engineering	346737211	Bagayatkar Yash Abhas	Internship
781	Electronics and Telecommunication Engineering	346737212	Bhoir Ishika Ravindra	Internship
782	Electronics and Telecommunication Engineering	346737213	Dabir Sakshi Padmakar	Internship
783	Electronics and Telecommunication Engineering	346737214	Deshpande Apurva Vidyadhar	Internship
784	Electronics and Telecommunication Engineering	346737215	Deshpande Prathama Vidyadhar	Internship
785	Electronics and Telecommunication Engineering	346737216	Dhanawade Prathamesh Jitendra	Internship
786	Electronics and Telecommunication Engineering	346737217	Gharat Mrunal Sandeep	Internship
787	Electronics and Telecommunication Engineering	346737218	Gharat Prajakta Dattatray	Internship
788	Electronics and Telecommunication Engineering	346737219	Godse Vedant Shrikant	Internship
789	Electronics and Telecommunication Engineering	346737220	Joshi Nikhil Janardan	Internship
790	Electronics and Telecommunication Engineering	346737221	Joshi Sujaldev Sunil	Internship
791	Electronics and Telecommunication Engineering	346737222	Kazi Zayan Shabbir Shainaz	Internship
792	Electronics and Telecommunication Engineering	346737223	Kokane Rushikesh Bhanudas	Internship
793	Electronics and Telecommunication Engineering	346737224	Koli Ashish Manoj	Internship
794	Electronics and Telecommunication Engineering	346737225	Kushwaha Akhilesh Gopal	Internship
795	Electronics and Telecommunication Engineering	346737226	Mane Mruganayani Vinod	Internship
796	Electronics and Telecommunication Engineering	346737227	Mhatre Swati Sunil	Internship
797	Electronics and Telecommunication Engineering	346737228	Mohite Komal Mandar	Internship
798	Electronics and Telecommunication Engineering	346737229	Pande Ravikumar Dayanand	Internship
799	Electronics and Telecommunication Engineering	346737230	Panditpautra Vriksh Kalpesh	Internship
800	Electronics and Telecommunication Engineering	346737231	Patil Akanksha Hemant	Internship
801	Electronics and Telecommunication Engineering	346737232	Patil Nitish Manoj	Internship
802	Electronics and Telecommunication Engineering	346737233	Patil Om Rajendra	Internship



TRUE COPY

[Signature]
Principal
Vishwaniketan's (I MBET)

803	Electronics and Telecommunication Engineering	346737234	Patil Piyush Baliram	Internship
804	Electronics and Telecommunication Engineering	346737235	Patil Vishal Rajendra	Internship
805	Electronics and Telecommunication Engineering	346737236	Phadtare Abhishek Hanumant	Internship
806	Electronics and Telecommunication Engineering	346737237	Rane Manish Dattaram	Internship
807	Electronics and Telecommunication Engineering	346737238	Shajol V. Shaji Joilymma	Internship
808	Electronics and Telecommunication Engineering	346737239	Sharma Richa Gianeshwar	Internship
809	Electronics and Telecommunication Engineering	346737240	Shinde Ashwini Deepak	Internship
810	Electronics and Telecommunication Engineering	346737241	Shinde Vishwajeet Dattatray	Internship
811	Electronics and Telecommunication Engineering	346737242	Sonawale Saurabh Subhash	Internship
812	Electronics and Telecommunication Engineering	346737243	Varekar Mayuri Bhagavatrao	Internship
813	Electronics and Telecommunication Engineering	346737244	Verma Shashank Rameshankar	Internship
814	Electronics and Telecommunication Engineering	346737245	Wadkar Vinay Anil	Internship
815	Electronics and Telecommunication Engineering	346737246	Wagh Rushabh Sanjay	Internship
816	Electronics and Telecommunication Engineering	346737247	Yagnik Riddhi	Internship
817	Electronics and Telecommunication Engineering	346737247	Khushwaha Akhilesh	Internship
818	Electronics and Telecommunication Engineering	346737248	Vriksh Panditpautra	Internship
819	Electronics and Telecommunication Engineering	346737249	Rushikesh Kokane	Internship
820	Electronics and Telecommunication Engineering	346737250	Pande Ravikumar	Internship
821	Electronics and Telecommunication Engineering	346737251	Ishika Bhoir	Internship
822	Electronics and Telecommunication Engineering	346737252	Prathama Deshpande	Internship
823	Electronics and Telecommunication Engineering	346737253	Apurva Deshpande	Internship
824	Electronics and Telecommunication Engineering	346737254	Ishika Bhoir	Internship
825	Electronics and Telecommunication Engineering	346737255	Mrunal Gharat	Internship
826	Electronics and Telecommunication Engineering	346737256	Akanksha Patil	Internship
827	Electronics and Telecommunication Engineering	346737257	Ashwini Shinde	Internship
828	Electronics and Telecommunication Engineering	346737258	Sakshi Padmakar Dabir	Internship
829	Electronics and Telecommunication Engineering	346737259	Mrugnayani vinod mane	Internship
830	Electronics and Telecommunication Engineering	346737260	Shajol V. Shaji	Internship
831	Electronics and Telecommunication Engineering	346737261	VINAY.A.WADKAR	Internship
832	Electronics and Telecommunication Engineering	346737262	Shashank Verma	Internship
833	Electronics and Telecommunication Engineering	346737263	Ashish Manoj Koli	Internship



TRUE COPY

[Signature]
Principal
Vishwaniketan's (I) MEET

834	Electronics and Telecommunication Engineering	346737264	Nikita Bharat Gharat	Internship
835	Computer Engineering	346724510	Shah Anish Ankush	Internship
836	Computer Science & Engineering (AIML)	346791110	Jadhav Yash Bharat	Internship
837	Computer Science & Engineering (AIML)	346791110	Deshpande Harsh Ashutosh	Internship
838	Computer Engineering	346724510	Patil Vishwajeet Ashokrao	Internship
839	Computer Engineering	346724510	Patil Anushka Anant	Internship
840	Computer Science & Engineering (AIML)	346791110	Gadiwale Shifa Mustaq Mohammed	Internship
841	Computer Science & Engineering (AIML)	346791110	Patil Shreyas Nitin	Internship
842	Electrical Engineering	346729310	Vaidya Mayuresh Satish	Internship
843	Computer Science & Engineering (AIML)	346791110	Peerzade Sahebraju Noorpasha	Internship
844	Computer Science & Engineering (AIML)	346791110	Asabe Aditya Navanath	Internship
845	Computer Science & Engineering (AIML)	346791110	Chavan Shreepad Ravindra	Internship
846	Computer Science & Engineering (AIML)	346791110	Jadhav Manish Prabhakar	Internship
847	Computer Science & Engineering (AIML)	346791110	Jadhav Mohini Prabhakar	Internship
848	Computer Science & Engineering (AIML)	346791110	Valsetwar Rohit Raju	Internship
849	Computer Science & Engineering (AIML)	346791110	Thakur Atul Muneem Singh	Internship
850	Computer Science & Engineering (AIML)	346791110	Ganesh Sapani	Internship
851	Computer Science & Engineering (AIML)	346791110	Kumar Om Prabhakar Upendra	Internship
852	Computer Science & Engineering (AIML)	346791110	Yele Hanumantrao Tukaram	Internship
853	Computer Science & Engineering (AIML)	346791110	Patil Abhinav Prakash	Internship
854	Computer Science & Engineering (AIML)	346791110	Navaneeth Harivikas Kommu	Internship
855	Computer Science & Engineering (AIML)	346791110	Gangadri T	Internship
856	Computer Engineering	346724510	Sneha Surendra Mhatre	Internship
857	Computer Science & Engineering (AIML)	346791110	B Ravikishor	Internship
858	Computer Engineering	346724510	Chavan Yashraj Prabhakar	Internship
859	Computer Engineering	346724510	Chaudhari Ayush Sunil	Internship
860	Computer Engineering	346724510	Sayyad Aaman Javed	Internship
861	Computer Engineering	346724510	Singh Yash Vijay	Internship
862	Computer Engineering	346724510	Bhoir Prachi Mahesh	Internship
863	Computer Science & Engineering (AIML)	346791110	Kumari Priyal	Internship
864	Electrical Engineering	346729310	Khare Aditya Ajay	Internship

TRUE COPY



[Signature]
Principal
Vishwaniketan's (i MEET)

865	Computer Science & Engineering (AIML)	346791110	Nayak Surajkumar Sushantkumar	Internship
866	Computer Engineering	346724510	Dudam Tanvi Suresh	Internship
867	Computer Engineering	346724510	Prasad Sagarkumar Krishna	Internship
868	Computer Science & Engineering (AIML)	346791110	Singh Aashu Rabindra	Internship
869	Computer Science & Engineering (AIML)	346791110	Bombe Kunal Dilip	Internship
870	Computer Engineering	346724510	Shreyash Bhesare	Internship
871	Computer Engineering	346724510	Mhatre Yash Keshav	Internship
872	Computer Engineering	346724510	Mokal Manish Prabhakar	Internship
873	Computer Science & Engineering (AIML)	346791110	Patil Pradnyesh Bhushan	Internship
874	Computer Engineering	346724510	Patil Piyush Naresh	Internship
875	Computer Science & Engineering (AIML)	346791110	Mokal Shubham Nandkishor	Internship
876	Computer Engineering	346724510	Malligawad Gagan	Internship
877	Computer Science & Engineering (AIML)	346791110	Mokal Abhinandan Alankar	Internship
878	Computer Engineering	346724510	Salunke Shubham Sanjay	Internship
879	Computer Engineering	346724510	Yash Umesh Thakur	Internship
880	Computer Engineering	346724510	Sumant Jadhav	Internship
881	Computer Science & Engineering (AIML)	346791110	Ulde Mayida Yaseen	Internship
882	Computer Science & Engineering (AIML)	346791110	Atharv Varshanand Patil	Internship
883	Electronics & Telecommunication Engineering	346737210	Kurde Mrunali Ganpat	Internship
884	Computer Science & Engineering (AIML)	346791110	Shingare Omkar Machindra	Internship
885	Computer Science & Engineering (AIML)	346791110	Singh Aditya Rajesh	Internship
886	Computer Science & Engineering (AIML)	346791110	Pawar Shivam Deepak	Internship
887	Computer Science & Engineering (AIML)	346791110	Dnyane Siddhant	Internship
888	Computer Engineering	346724510	Singh Rahul Kumar Vinay	Internship
889	Electronics & Telecommunication Engineering	346737210	Bhoir Mahima Vishwanath	Internship
890	Computer Science & Engineering (AIML)	346791110	Kulkarni Vaishnavi	Internship
891	Electronics & Telecommunication Engineering	346737210	Bhoir Vicky Satish	Internship
892	Computer Engineering	346724510	Dubai Omkar Baburao	Internship
893	Computer Engineering	346724510	Wala Paras Purshottam	Internship
894	Computer Science & Engineering (AIML)	346791110	Mhatre Mihir Shekhar	Internship
895	Computer Engineering	346724510	Gavandi Nihal Santosh	Internship



TRUE COPY

[Signature]
Principal
Vishwaniketan's (i MEET)

896	Computer Engineering	346724510	Chitnis Shreyas Girish	Internship
897	Computer Engineering	346724510	Patil Rashmi Sambhaji	Internship
898	Mechanical Engineering	346761210	Shinde Sanket Dipak	Internship
899	Computer Science & Engineering (AIML)	346791110	Jadhav Chinmay Santosh	Internship
900	Computer Engineering	346724510	Jha Jaya Shailesh Kumar	Internship
901	Computer Science & Engineering (AIML)	346791110	Patil Rohan Rajendra	Internship
902	Mechanical Engineering	346761210	Baikar Rohit Gopal	Internship
903	Computer Engineering	346724510	Shelke Sneha Mahendra	Internship
904	Computer Engineering	346724510	Khutle Swapnali Subhash	Internship
905	Computer Engineering	346724510	Nikhil Choudhary	Internship
906	Mechanical Engineering	346761210	Rohit Sharma	Internship
907	Computer Engineering	346724510	Aman Singh	Internship
908	Computer Engineering	346724510	Pradeep Singh	Internship
909	Computer Science & Engineering (AIML)	346791110	Yash Chorghe	Internship
910	Computer Science & Engineering (AIML)	346791110	Jayesh Thatte	Internship
911	Electrical Engineering	346729310	Rinky Maithy	Internship
912	Computer Science & Engineering (AIML)	346791110	Bandal Shubham Santosh	Internship
913	Mechanical Engineering	346761210	Dhotre Ravi Ajay	Internship
914	Mechanical Engineering	346761210	Saqlain bubere	Internship
915	Electrical Engineering	346729310	Dalvi Rohan Gangaram	Internship
916	Civil Engineering	346719110	Gophan shravan anil	Internship
917	Mechanical Engineering	346761210	Kengar Shreyas madhukar	Internship
918	Computer Science & Engineering (AIML)	346791110	Verma Vivek	Internship
919	Civil Engineering	346719110	Mali pranit prakash	Internship
920	Civil Engineering	346719110	Adhikari swamini shridhar	Internship
921	Mechanical Engineering	346761210	Mhatre suyog Shankar	Internship
922	Civil Engineering	346719110	PATIL JAYESH ANANTA	Internship
923	Mechanical Engineering	346761210	PATIL SAHIL SUNIL	Internship
924	Computer Science & Engineering (AIML)	346791110	Thakur Yash Dipak	Internship
925	Civil Engineering	346719110	Gite JHANVI PRATAP	Internship
926	Computer Engineering	346724510	Mandhare Rohan Rajendra	Internship

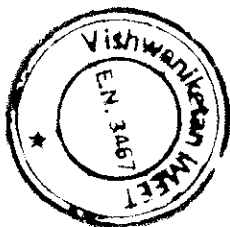

TRUE COPY

[Signature]
Principal
Vishwaniketan's (i) MEET

927	Computer Engineering	346724510	Inamdar Yashwini Santosh	Internship
928	Electrical Engineering	346729310	Mene Rutik Rajesh	Internship
929	Computer Engineering	346724510	Nilawar Sheetal Vitthalrao	Internship
930	Computer Engineering	346724510	Deshmukh Rohit Dattatrey	Internship
931	Mechanical Engineering	346761210	Bhagat Adarsh Abhiman	Internship
932	Mechanical Engineering	346761210	Natikar Aditya Babu	Internship
933	Computer Engineering	346724510	Shelke Aditya Sanjay	Internship
934	Computer Engineering	346724510	Zavare Swaraj Dilip	Internship
935	Computer Engineering	346724510	Kamble Sayali Vikas	Internship
936	Computer Science & Engineering (AIML)	346791110	Anushka Uday Sarge	Internship
937	Civil Engineering	346719110	Pawar Sushant Subhash	Internship
938	Computer Engineering	346724510	Mantri Samved Rajesh	Internship
939	Computer Science & Engineering (AIML)	346791110	Patil Aman Prashant	Internship
940	Computer Science & Engineering (AIML)	346791110	Sawant Komal Kailash	Internship
941	Computer Science & Engineering (AIML)	346791110	Shingare Vaibhavi shingare	Internship
942	Computer Engineering	346724510	Nagvekar Sayali Hemant	Internship
943	Electrical Engineering	346729310	Parab Vanshita Ganesh	Internship
944	Electronics & Telecommunication Engineering	346737210	Suyash Santosh Tambade	Internship
945	Computer Engineering	346724510	Kasare Yash Ganesh	Internship
946	Mechanical Engineering	346761210	Gaikar Harsh	Internship
947	Civil Engineering	346719110	Jangam Akshay Anant	Internship
948	Computer Engineering	346724510	Patil Saurabh Sukhdeo	Internship
949	Civil Engineering	346719110	Pawar Sairaj Sandeep	Internship
950	Computer Science & Engineering (AIML)	346791110	Kale Aditya Dipak	Internship
951	Mechanical Engineering	346761210	Khot Shubham Shailesh	Internship
952	Mechanical Engineering	346761210	Kulkarni Atharva Mahesh	Internship
953	Computer Science & Engineering (AIML)	346791110	Gunjan Khushi Tigga	Internship
954	Computer Engineering	346724510	Dabir Sanika Jayendra	Internship
955	Electrical Engineering	346729310	Kedari Rutuksha Suresh	Internship
956	Computer Engineering	346724510	Bhangale Yogeshwar Nitin	Internship
957	Electrical Engineering	346729310	Saruk Dnyaneshwar Dilip	Internship



TRUE COPY

[Signature]
Principal

958	Mechanical Engineering	346761210	Singh Shivam Santosh	Internship
959	Electrical Engineering	346729310	Pardhi Abhijeet Prabhakar	Internship
960	Electrical Engineering	346729310	Bankar Abhishek Narayan	Internship
961	Civil Engineering	346719110	Kokate Aryan Hiranman	Internship
962	Electrical Engineering	346729310	Rane Devarsh Krushna	Internship
963	Computer Science & Engineering (AIML)	346791110	Tatkare Siddhesh Prashant	Internship
964	Mechanical Engineering	346761210	Mali Hitesh Govind	Internship
965	Computer Engineering	346724510	Vaidya Aditya Atul	Internship
966	Mechanical Engineering	346761210	Yadav Abhishek Sanjay	Internship
967	Computer Engineering	346724510	Hivale Shreyas Ravindra	Internship
968	Computer Science & Engineering (AIML)	346791110	Ganesh Sapani	Internship
969	Computer Science & Engineering (AIML)	346791110	Ganesh Sapani	Internship
970	Computer Engineering	346724510	Yogeshwar Bhangale	Internship
971	Computer Engineering	346724510	Yash Singh	Internship
972	Computer Science & Engineering (AIML)	346791110	Atul Thakur	Internship
973	Computer Science & Engineering (AIML)	346791110	Atul Thakur	Internship
974	Computer Engineering	346724510	Shubham Salunke	Internship
975	Computer Engineering	346724510	Shubham Salunke	Internship
976	Electrical Engineering	346729310	Aditya Khare	Internship
977	Computer Science & Engineering (AIML)	346791110	Suraj Nayak	Internship
978	Computer Engineering	346724510	Yashraj Chavan	Internship
979	Computer Science & Engineering (AIML)	346791110	Rohit Valsetvar	Internship
980	Computer Science & Engineering (AIML)	346791110	Rohit Valsetvar	Internship
981	Computer Engineering	346724510	Abhang Shruti Tanaji	Internship
982	Computer Engineering	346724510	Bhadane Gaurav Bhayyasaheb	Internship
983	Computer Engineering	346724510	Bhagat Siddhi Ramakant	Internship
984	Computer Engineering	346724510	Bhalerao Pratik Pandurang	Internship
985	Computer Engineering	346724510	Bhoir Jayesh Ramakant	Internship
986	Computer Engineering	346724510	Bhole Yash Vilas	Internship
987	Computer Engineering	346724510	Bhosale Anuraj Chandrakant	Internship
988	Computer Engineering	346724510	Burange Poonam Govind	Internship

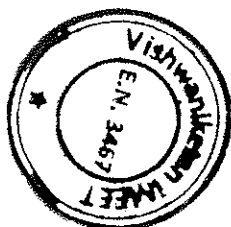

TRUE COPY

[Signature]
Principal
Vishwaniketan's (i) MEET

989	Computer Engineering	346724510	Deshmukh Pratik Dnyaneshwar	Internship
990	Computer Engineering	346724510	Deshpande Sutej Sunil	Internship
991	Computer Engineering	346724510	Dhakane Sachin Sanjay	Internship
992	Computer Engineering	346724510	Dongre Krishnam Akshay	Internship
993	Computer Engineering	346724510	Gawade Samruddhi Santosh	Internship
994	Computer Engineering	346724510	Ghadge Rachana Jeevan	Internship
995	Computer Engineering	346724510	Gurav Samiksha Mahesh	Internship
996	Computer Engineering	346724510	Hegde Sudeep Deepak	Internship
997	Computer Engineering	346724510	Hindlekar Hrishikesh Vijay	Internship
998	Computer Engineering	346724510	Jape Supriya Baban	Internship
999	Computer Engineering	346724510	Joshi Venkatesh Arun	Internship
1000	Computer Engineering	346724510	Juikar Riya Hemant	Internship
1001	Computer Engineering	346724510	Kadam Pranali Dilip	Internship
1002	Computer Engineering	346724510	Kalbhor Sumit Subhash	Internship
1003	Computer Engineering	346724510	Kanse Kiran Mahadev	Internship
1004	Computer Engineering	346724510	Kapse Ajinkya Chandrakant	Internship
1005	Computer Engineering	346724510	Kawale Swagata Nitesh	Internship
1006	Computer Engineering	346724510	Khopade Swaraj Shridhar	Internship
1007	Computer Engineering	346724510	Kolpe Hrishikesh Jitendra	Internship
1008	Computer Engineering	346724510	Kunte Harsh Deepak	Internship
1009	Computer Engineering	346724510	Mahto Diya Dineshkumar	Internship
1010	Computer Engineering	346724510	Malkar Manasi Dinesh	Internship
1011	Computer Engineering	346724510	Mhatre Rashmi Upendra	Internship
1012	Computer Engineering	346724510	Mhatre Upasana Shivdas	Internship
1013	Computer Engineering	346724510	Mistry Jyoti Debidas	Internship
1014	Computer Engineering	346724510	Mokal Karishma Gajanan	Internship
1015	Computer Engineering	346724510	Mokal Vaishnavi Prabhakar	Internship
1016	Computer Engineering	346724510	Mourya Ankita Hira	Internship
1017	Computer Engineering	346724510	Nalage Chaitanya Ganpat	Internship
1018	Computer Engineering	346724510	Nandgaonkar Sharvari Rajendra	Internship
1019	Computer Engineering	346724510	Parange Shubham Rajendra	Internship

TRUE COPY



[Signature]
Principal
Vishwaniketan's (i) MEET

1020	Computer Engineering	346724510	Patel Naresh Kanaram	Internship
1021	Computer Engineering	346724510	Patil Dhanashree Subhash	Internship
1022	Computer Engineering	346724510	Patil Jayesh Hiralal	Internship
1023	Computer Engineering	346724510	Patil Purnima Rajendra	Internship
1024	Computer Engineering	346724510	Patil Siddhesh Sambhaji	Internship
1025	Computer Engineering	346724510	Patole Nutan Uttam	Internship
1026	Computer Engineering	346724510	Pawar Mansi Jayawant	Internship
1027	Computer Engineering	346724510	Pawar Sonika Sampat	Internship
1028	Computer Engineering	346724510	Pranjal Bhosekar	Internship
1029	Computer Engineering	346724510	Raut Neha Anil	Internship
1030	Computer Engineering	346724510	Rawate Aashutosh Kailas	Internship
1031	Computer Engineering	346724510	Ray Apratim Achintya	Internship
1032	Computer Engineering	346724510	Salvi Akshay Nandkumar	Internship
1033	Computer Engineering	346724510	Sapane Akshay Prakash	Internship
1034	Computer Engineering	346724510	Sasane Dakshata Sanjay	Internship
1035	Computer Engineering	346724510	Sathe Suchitra Suresh	Internship
1036	Computer Engineering	346724510	Shaikh Rahat Hamid	Internship
1037	Computer Engineering	346724510	Shelar Najuka Dinesh	Internship
1038	Computer Engineering	346724510	Shelke Ajay Manohar	Internship
1039	Computer Engineering	346724510	Shukla Vishal Anjani	Internship
1040	Computer Engineering	346724510	Singh Roshni Firnath	Internship
1041	Computer Engineering	346724510	Singh Samiksha Pratap	Internship
1042	Computer Engineering	346724510	Somwanshi Aniket Ashok	Internship
1043	Computer Engineering	346724510	Thale Srushti Nayan	Internship
1044	Computer Engineering	346724510	Thale Vaishnavi Dinesh	Internship
1045	Computer Engineering	346724510	Thorat Pratiksha Yashwant	Internship
1046	Computer Engineering	346724510	Thorat Pratyush Kailas	Internship
1047	Computer Engineering	346724510	Ugale Janhavi Madhukar	Internship
1048	Computer Engineering	346724510	Upadhyay Tirth Jayesh	Internship
1049	Computer Engineering	346724510	Vele Deven Pramod	Internship
1050	Computer Engineering	346724510	Vishwakarma Ajay Ramharsh	Internship



TRUE COPY

[Signature]
Principal
Vishwaniketan's (i.M.B.E.T)

1051	Computer Engineering	346724510	Wakde Shirin Subhash	Internship
1052	Computer Engineering	346724510	Zalte Ravina Vitthal	Internship
1053	Computer Engineering	346724510	Hudgi Gururaj Mallikarjun	Internship
1054	Computer Engineering	346724510	Jadhav Akash Balasaheb	Internship
1055	Computer Engineering	346724510	Mishra Neha Digvijay	Internship
1056	Computer Engineering	346724510	Telange Aditya Prafull	Internship
1057	Computer Engineering	346724510	Mokal Varun Vikas	Internship
1058	Computer Engineering	346724510	Solanki Akshay Mukesh	Internship
1059	Computer Engineering	346724510	Tandel Aatish Prakash	Internship
1060	Computer Engineering	346724510	Amrale Prathmesh Sanjay	Internship
1061	Computer Engineering	346724510	Dalvi Nivedita Yashwant	Internship
1062	Computer Engineering	346724510	Deshmukh Punyak Manoj	Internship
1063	Computer Engineering	346724510	Dhanawade Dhanashree Hanamant	Internship
1064	Computer Engineering	346724510	Gaikar Prabodh Namdev	Internship
1065	Computer Engineering	346724510	Gajre Abhijeet Amrut	Internship
1066	Computer Engineering	346724510	Jadhav Tanmay Sanjay	Internship
1067	Computer Engineering	346724510	Kasle Vedant	Internship
1068	Computer Engineering	346724510	Ketkar Shreya Chandrashekhar	Internship
1069	Computer Engineering	346724510	Khaladkar Omkar Sudhir	Internship
1070	Computer Engineering	346724510	Koli Anushri Subhash	Internship
1071	Computer Engineering	346724510	Kulkarni Kirti Rahul	Internship
1072	Computer Engineering	346724510	Mane Rutvij Mahendra	Internship
1073	Computer Engineering	346724510	Mankawle Disha Rajendra	Internship
1074	Computer Engineering	346724510	Mishra Dhruvkumar Anusuyaprasad	Internship
1075	Computer Engineering	346724510	Mishra Pratik Awadhesh	Internship
1076	Computer Engineering	346724510	Mohite Divyanka	Internship
1077	Computer Engineering	346724510	Mokal Akshaya Namdev	Internship
1078	Computer Engineering	346724510	Mulik Diksha Dilip	Internship
1079	Computer Engineering	346724510	Naik Pragati Gopal	Internship
1080	Computer Engineering	346724510	Narayankar Chaitanya Dudambhai	Internship
1081	Computer Engineering	346724510	Narharshettiwar Atharv Anil	Internship



TRUE COPY

[Signature]
Principal
Vishwaniketan's (I) MBET

1082	Computer Engineering	346724510	Narwade Shyamal Sanjay	Internship
1083	Computer Engineering	346724510	Patil Dhanashree Dhananjay	Internship
1084	Computer Engineering	346724510	Patil Mahesh Balkrishna	Internship
1085	Computer Engineering	346724510	Patil Mamata Sanjay	Internship
1086	Computer Engineering	346724510	Patil Mrunali Baban	Internship
1087	Computer Engineering	346724510	Patil Rutuja Sujitkumar	Internship
1088	Computer Engineering	346724510	Patil Shruti Kishor	Internship
1089	Computer Engineering	346724510	Patil Sourav	Internship
1090	Computer Engineering	346724510	Patil Swapnil Mohandas	Internship
1091	Computer Engineering	346724510	Patil Trupti Pravin	Internship
1092	Computer Engineering	346724510	Pingale Alankar Anil	Internship
1093	Computer Engineering	346724510	Rajadhyaksha Prasad Shantaram	Internship
1094	Computer Engineering	346724510	Raut Aniket	Internship
1095	Computer Engineering	346724510	Raut Raturaj Sanjay	Internship
1096	Computer Engineering	346724510	Sawant Ashutosh Arun	Internship
1097	Computer Engineering	346724510	Shinde Avdhut Shrihari	Internship
1098	Computer Engineering	346724510	Singh Muskan Vijay	Internship
1099	Computer Engineering	346724510	Singh Ritika Pradeep	Internship
1100	Computer Engineering	346724510	Singh Ritu Nagendra	Internship
1101	Computer Engineering	346724510	Tembhe Harshad Ramesh	Internship
1102	Computer Engineering	346724510	Vichare Shruti Sudhir	Internship
1103	Computer Engineering	346724510	Vidwans Ajinkya Dileep	Internship
1104	Computer Engineering	346724510	Watekar Komal	Internship
1105	Computer Engineering	346724510	Wavekar Sujan Sunil	Internship
1106	Computer Engineering	346724510	Bharmbe Jay Anil	Internship
1107	Computer Engineering	346724510	Chaudhari Ayush Suhas	Internship
1108	Computer Engineering	346724510	Choudhari Swapnil Purushottam	Internship
1109	Computer Engineering	346724510	Dhaygude Akshay Sudam	Internship
1110	Computer Engineering	346724510	Dubey Kamal	Internship
1111	Computer Engineering	346724510	Gaonkar Aniketh Narayan	Internship
1112	Computer Engineering	346724510	Gawade Piyush Shrikant	Internship

TRUE COPY



[Signature]
Principal
Vishwaniketan's (i) MEET

1113	Computer Engineering	346724510	Holkar Hitesh Satish	Internship
1114	Computer Engineering	346724510	Joshi Dharmik Rajesh	Internship
1115	Computer Engineering	346724510	Kalel Omkar Rajaram	Internship
1116	Computer Engineering	346724510	Kate Aditya Sunil	Internship
1117	Computer Engineering	346724510	Kulkarni Pavan Govindrao	Internship
1118	Computer Engineering	346724510	Kulkarni Sushil Vijaykumar	Internship
1119	Computer Engineering	346724510	Mane Omkar Arvind	Internship
1120	Computer Engineering	346724510	More Jatin Sunil	Internship
1121	Computer Engineering	346724510	Narendraguru Harikrishnan	Internship
1122	Computer Engineering	346724510	Nidhi Pankaj Santosh	Internship
1123	Computer Engineering	346724510	Patil Sarvesh Pravin	Internship
1124	Computer Engineering	346724510	Pingale Kalyani Rajendra	Internship
1125	Computer Engineering	346724510	Sharma Ritik Devidayal	Internship
1126	Computer Engineering	346724510	Sherkhane Sneha	Internship
1127	Computer Engineering	346724510	Shimpi Shivani Amol	Internship
1128	Computer Engineering	346724510	Shrinagarwar Vaibhav Pravin	Internship
1129	Computer Engineering	346724510	Singh Srijan Santosh Kumar	Internship
1130	Computer Engineering	346724510	Terde Jatin Yogesh	Internship
1131	Computer Engineering	346724510	Uchil Samrudh Sushant	Internship
1132	Computer Engineering	346724510	Bhale Prasad Milind	Internship
1133	Computer Engineering	346724510	Bhandwalkar Payal Uttam	Internship
1134	Computer Engineering	346724510	Borkar Om Sanjay	Internship
1135	Computer Engineering	346724510	Chandan Avinash Anil	Internship
1136	Computer Engineering	346724510	Chaudhari Vipul Atmaram	Internship
1137	Computer Engineering	346724510	Darekar Chaitali Dilip	Internship
1138	Computer Engineering	346724510	Deshmukh Siddhika Umesh	Internship
1139	Computer Engineering	346724510	Dhanawade Shreyash Murlidhar	Internship
1140	Computer Engineering	346724510	Gaurav Anil Khalapurkar	Internship
1141	Computer Engineering	346724510	Gondhali Prachi Vaman	Project Work
1142	Computer Engineering	346724510	Gupta Aakash Mahesh	Project Work
1143	Computer Engineering	346724510	Gupta Ajitkumar Ramhausila	Project Work

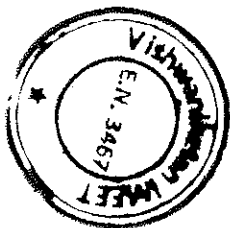

TRUE COPY

[Signature]
Principal
Vishwaniketan's (i) MBET

1144	Computer Engineering	346724510	Jangale Bhagwan Rambhau	Project Work
1145	Computer Engineering	346724510	Jha Ashish Anil Kumar	Project Work
1146	Computer Engineering	346724510	Kadave Pratham Ramesh	Project Work
1147	Computer Engineering	346724510	Kamble Deepak Dattatraya	Project Work
1148	Computer Engineering	346724510	Keni Yash Manoj	Project Work
1149	Computer Engineering	346724510	Khanviikar Prathamesh Mahesh	Project Work
1150	Computer Engineering	346724510	Koli Rahul Laxman	Project Work
1151	Computer Engineering	346724510	Korgaonkar Sakshi Santosh	Project Work
1152	Computer Engineering	346724510	Kulkarni Priya Sanjay	Project Work
1153	Computer Engineering	346724510	Lahane Deep Manohar	Project Work
1154	Computer Engineering	346724510	Lawand Sumit Nandkumar	Project Work
1155	Computer Engineering	346724510	Mahulkar Rasika Rajendra	Project Work
1156	Computer Engineering	346724510	Malekar Nishant Nischal	Project Work
1157	Computer Engineering	346724510	Mishra Utkarsh	Project Work
1158	Computer Engineering	346724510	Mokal Sneha Rajendra	Project Work
1159	Computer Engineering	346724510	Mulgir Eshwar Subhash	Project Work
1160	Computer Engineering	346724510	Negi Rishika Krishna	Project Work
1161	Computer Engineering	346724510	Nikam Parshuram Sanjay	Project Work
1162	Computer Engineering	346724510	Pandey Nimish Ajaykumar	Project Work
1163	Computer Engineering	346724510	Patil Saksham Sachin	Project Work
1164	Computer Engineering	346724510	Patil Swarupa Hemant	Project Work
1165	Computer Engineering	346724510	Patil Vedashree Manojkumar	Project Work
1166	Computer Engineering	346724510	Pawar Digvijay Rajesh	Project Work
1167	Computer Engineering	346724510	Pawar Shyam Ranjeet	Project Work
1168	Computer Engineering	346724510	Pawar Vedant Hanmant	Project Work
1169	Computer Engineering	346724510	Pednekar Sanket Hariram	Project Work
1170	Computer Engineering	346724510	Pednekar Shubham Shamrao	Project Work
1171	Computer Engineering	346724510	Puranik Rohan Anant	Project Work
1172	Computer Engineering	346724510	Rane Nikhil	Project Work
1173	Computer Engineering	346724510	Reddy Annapu Chenna Reddy Venkata Reddy	Project Work
1174	Computer Engineering	346724510	Reejhwani Ritik Brijlal	Project Work



TRUE COPY

[Signature]
Principal
Vishwaniketan's (i) MBEET

1175	Computer Engineering	346724510	Sadake Prathmesh Vijay	Project Work
1176	Computer Engineering	346724510	Salgar Urmila Vijay	Project Work
1177	Computer Engineering	346724510	Sargar Amol Shankar	Project Work
1178	Computer Engineering	346724510	Sawant Pratap Madhukar	Project Work
1179	Computer Engineering	346724510	Shankar Abhijeet Sudhir Kumar	Project Work
1180	Computer Engineering	346724510	Shete Anagha	Project Work
1181	Computer Engineering	346724510	Shinde Amey Bharat	Project Work
1182	Computer Engineering	346724510	Shinde Digvijay Pravin	Project Work
1183	Computer Engineering	346724510	Shinde Rahul Gajendra	Project Work
1184	Computer Engineering	346724510	Shirke Vinayak Dayanand	Project Work
1185	Computer Engineering	346724510	Singh Aditya Ajay	Project Work
1186	Computer Engineering	346724510	Singh Sakshi Sudhanshu	Project Work
1187	Computer Engineering	346724510	Singh Sanjivani Vinod	Project Work
1188	Computer Engineering	346724510	Singh Sukritee Sanjay	Project Work
1189	Computer Engineering	346724510	Sorte Chirag Jeevan	Project Work
1190	Computer Engineering	346724510	Takawade Siddhi Shivprasad	Project Work
1191	Computer Engineering	346724510	Talekar Sarthak Vijay	Project Work
1192	Computer Engineering	346724510	Tandale Shreya Sandeep	Project Work
1193	Computer Engineering	346724510	Thale Riddhi Ramesh	Project Work
1194	Computer Engineering	346724510	Thombare Sakshi Sanjay	Project Work
1195	Computer Engineering	346724510	Turkar Raj Hariprasad	Project Work
1196	Computer Engineering	346724510	Upase Mehul Bhojraj	Project Work
1197	Computer Engineering	346724510	Chatale Amruta Bhausaheb	Project Work
1198	Computer Engineering	346724510	Chikhalkar Manasi Santosh	Project Work
1199	Computer Engineering	346724510	Deshmukh Shreyas Mohan	Project Work
1200	Computer Engineering	346724510	Kumbhar Saurabh Arjun	Project Work
1201	Computer Engineering	346724510	Mulani Amaan Sharif	Project Work
1202	Computer Engineering	346724510	Patil Jayesh Rajendra	Project Work
1203	Computer Engineering	346724510	Patil Pratiksha Hanumant	Project Work
1204	Computer Engineering	346724510	Patil Sarvesh Nandkumar	Project Work
1205	Computer Engineering	346724510	Patil Tejas Subhash	Project Work

TRUE COPY

[Signature]
Principal
Vishwaniketan's



1206	Computer Engineering	346724510	Qureshi Nida Raees	Project Work
1207	Computer Engineering	346724510	Taware Niranjan Umesh	Project Work
1208	Computer Engineering	346724510	Telang Sambhaji Bharat	Project Work

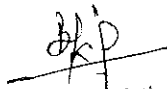

TRUE COPY

Principal
Vishwaniketan's (i MBET)

5

13th July 2021

TO WHOM IT MAY CONCERN

This is to certify that **Ms.Ishika Ravindra Bhoir** bearing code: **IW21HRD-M001349** has successfully completed an internship with **IFORTIS WORLDWIDE** as a **Human Resources Trainee** in the Human Resource Department from **26/05/2021** to **10/07/2021**.

Top Skills Covered:

- Talent Acquisition
- HR Administration & Shared services
- Communication
- Talent Management & Development
- Employee Relations & Risk Management
- HR Information Management

Besides showing high comprehension capacity, managing assignments with the utmost expertise and exhibiting maximal efficiency, he/she has also maintained an outstanding professional demeanor and showcased excellent moral character throughout the internship period.

We hereby certify that the candidate's overall work is **good** to the best of our knowledge.

Wishing the candidate all the best for his/her future endeavors.

For **IFORTIS WORLDWIDE**,



Chief Executive Officer

AMERICAN RULER PRIVATE LIMITED
No.704, Kuruvikulam KN, Sankarankovil,
Tirunelveli, Tamilnadu,
INDIA - 627 754.

TRUE COPY

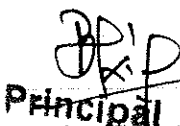

Principal

Vishwaniketan's (iMEET) | No.704, Kuruvikulam KN, Sankarankovil TK, Tirunelveli, Tamilnadu - 627754 (INDIA)
CIN: U1109TN2021PTC143811 | GSTIN: 33AAVCA2781N1Z1



Head of Department
Electronics & Tele-communication Engineering
Vishwaniketan's iMEET



Internship Letter

Date: 4th December 2021

To Whom It May Concern

This letter is to certify that Vriksh Panditpautra has successfully completed his internship program of 11 months with Unbox Innovations. His internship tenure was from December 29th 2020 to November 30th 2021. He was working with the Technical team as a full stack developer and worked on both the backend and front end part and was actively & diligently involved in the projects and tasks assigned to him.

During the span, we found him to be a punctual and hardworking person. His learning powers are good and he picks up swiftly. His feedback and evaluation proved that he learned keenly. Moreover, his interpersonal and communication skills are brilliant.

We wish him a bright future.

Sincerely,

Khushboo Ray
HR, Unbox Innovation

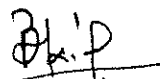
Principal
Vishwaniketan's (I MEET)

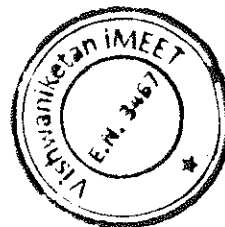



Head of Department
Electronics & Tele-communication Engineering
Vishwaniketan's IMEET

TRUE COPY

Authorized Signatory

Name of company : Unbox innovations



Principal
Vishwaniketan's (I MEET)



Head of Department
Electronics & Tele-communication Engineering
Vishwaniketan's iMEET

TRUE COPY



→ Acknowledgement - Copy

BOMBAY DYEING & MANUFACTURING CO. LTD.

Communications to be addressed to :

POLYESTER DIVISION

A-1, PATALGANGA INDL. AREA, P. O. BOX NO.: 5,

PATALGANGA, RAIGAD - 410 220 (MS), INDIA

PHONE: +91 02192 251096, FAX: +91 02192 250263

E-MAIL polyester@bombaydyeing.com

E-MAIL someshwar.kale@bombaydyeing.com

CIN : L17120MH1879PLC000037

June 22, 2021.

To,
Dr. B. R. Patil,
Principal,
Vishwaniketan's
Institute of Management Entrepreneurship & Engineering Technology (IMEET)
Survey No.:52, Khumbhivali, Near Khalapur Toll Naka,
Off Mumbai-Pune Expressway, Tal.: Khalapur,
Dist.: Raigad - 410 202.

Dear Sir,

With reference to your Letter Ref.: ViMEET/ - / - / 2021-22 dated 21st June, 2021 we would like to inform you that we can allow your student Mr. Aniket H. Shirke studying in 3rd Year B.E. - Electrical for Summer Training from for Internship from 1st July to 30th July, 2021 (one month) in our Organization / Plant. His timing will be from 11:00 hrs to 16:00 hrs.

Please note, our Company does not have the policy of paying stipend to Summer Training Students. He is not allowed to use Company Transport as well Canteen facility.

Photography is strictly prohibited in the Plant, hence please instruct your student not to use mobile phone for photography in the Plant. Violation will lead to seizure of phone and they will not allow continuing the training further.

Thanking you,

Yours Faithfully,
For THE BOMBAY DYEING & MANUFACTURING CO. LTD.

SOMESHWAR KALE
DY. GENERAL MANAGER - P. & A.

Copy → Mr. A. H. Shirke, Student.
Mr. PC Panda, GM - Engineering,
Fire & Safety Dept.
Security Dept. - for Paper pass
In-plant Trainee File

Received
28/07/2021
Principal
Vishwaniketan's (I MEET)



BOMBAY REALTY



Bombay Dyeing & Manufacturing Co. Ltd.

The Bombay Dyeing & Mfg. Co. Ltd. - 1, Wacha International Centre (Bombay Dyeing & Manufacturing Co. Ltd.), Pandurang Budhkar Marg, Worli.
H/MCAPPRENTICE-TRADEUN-PLANT, RAIGAD-410220 (MS) India. Phone: +91 2192 251096 - Fax: +91 2192 250263

Regd. Office: Navjee House, J.N. Herod Road, Mumbai - 400 001.

CIN : L17120MH1879PLC000037 Email: polyester@bombaydyeing.com

Website: www.bombaydyeing.com

TRUE COPY

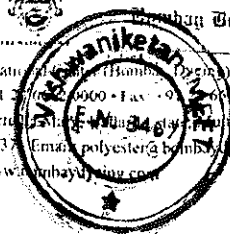

Principal
Vishwaniketan's (I MEET)



BOMBAY DYEING

All Communications to be addressed to :
POLYESTER DIVISION

A-1, PATALGANGA INDL AREA, P. O. BOX NO.: 5,
PATALGANGA, RAIGAD - 410 220. (MS), INDIA
PHONE: +91 02192 258346, FAX: +91 02192 250283
E-MAIL: chandrashekhar.shende@bombaydyeing.com
CIN: L17120MH1879PLC000037

August 2, 2021.

TO WHOMSOEVER IT MAY CONCERN

This is to certify that Mr. Aniket H. Shirke, studying in 3rd Year B.E. – Electrical student of Vishwaniketan's Institute of Management Entrepreneurship & Engineering Technology (IMEET) Tal.: Khalapur, Dist.: Raigad – 410 202 has successfully completed the In-Plant Training from 1st July to 30th July, 2021 (one month) in Electrical Department under the guidance of Mr. R. C. Thakur, Asst. General Manager – Electrical in our Company.

We wish him success in his future studies.

For THE BOMBAY DYEING & MANUFACTURING CO. LTD.

SOMESHWAR KALE
DY. GENERAL MANAGER – P. & A.

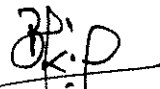

Principal
Vishwaniketan's (I MEET)



BOMBAY REALTY

Bombay Bureau

TRUE COPY

राष्ट्रीय केमिकल्स एण्ड फर्टिलाइजर्स लिमिटेड



साथ बड़े समृद्धि की ओर

मानव संसाधन विकास केंद्र

थळ इकाई, अलिबाग-रायगड-402 208

प्रमाणपत्र / Certificate

Name : Anuja Dhananjay Ladge

Institution : Vishwaniketan Institute of Management & Entrepreneurship & Engineering College, Khalapur

Branch : B.E. (Electrical)

Period of Training : 31 days, from 22/01/2021 to 20/02/2021

Leave taken during Training : 00 days

Off days & Holidays : 05 days

Nature of Training : Intensive Training in "Electrical Workshop & Electrical Engineering Services"

REPORT OF TRAINING

	Excellent	Very Good	Good	Average
1. Conduct	✓			
2. Punctuality	✓			
3. Knowledge				
4. Interview Rating			✓	
5. Report Rating		✓		



Principal

Vishwaniketan's (I MEE)

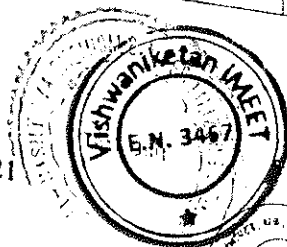
Date : 20/02/2021

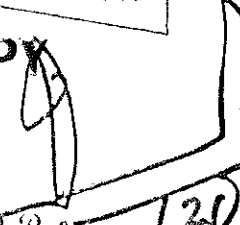

TRUE COPY

For and on Behalf of R. C. F. Ltd.

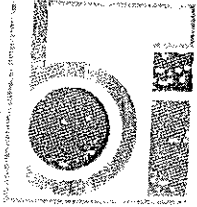
20/2/21



Brite Industries

Air Conditioning Engineers, Licensed Electrical Contractors & Dealers For Refrigerant Gases

Regd. Office : 67-A, Hafizali Bahadur Khan Marg, Suryaji Compound, Behind Khatau Mills, Byculla (W), Mumbai - 400 011.
Tel. : 2301 2145 • Telefax : 2301 2146 • E-mail : brite.inds@hotmail.com

Uran Office : 1st Floor, Sagar Apts., Opp. DSC Lines, Uran-Mora Road, Uran Dist. Raigad - 400 702. • Tel. : 2722 3415

Issue dated: 31th October 2020

CERTIFICATE OF INTERNSHIP

TO WHOMSOEVER IT MAY CONCERN

This is to certify that Mr. Shardul Shekhar Gatare bearing aadhar no. 3836 8144 2669, student of **Mechanical Engineering** from Vishwaniketan's IMEET College (Khalapur). He has done his internship successfully completed for the three months in Brite Industries, Mumbai from (11th July 2020 to 17th October 2020).

During the internship, Mr. Shardul Shekhar Gatare has worked of **Air Conditioning & Refrigeration**. He demonstrated goods in installing, servicing and repairs with a self-motivated attitude to learn new things. His performance exceeded expectations and was able to complete the project successfully on time.

We wish him all the best for his future endeavours.

For Brite Industries.

Signature

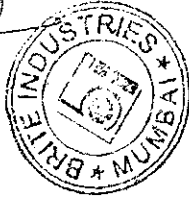

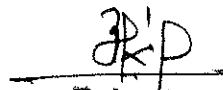
Principal
Vishwaniketan's (IMEET)

TRUE COPY



राष्ट्रीय केमिकल्स एण्ड फर्टिलाइजर्स लिमिटेड



मानव संसाधन विकास केंद्र

मानव संसाधन विकास केंद्र

थळ इकाई, अलिबाग-रायगड-402 208

प्रमाणपत्र / Certificate

Name :- Mr. Nishant Balkrishna Patil

Institution :- Vishwaniketan (IMEET), Khalapur

Branch :- Mechanical Engineering

Period of Training :- 14 days from 01.08.2021 to 14.08.2021

Leave taken during training :- 00 days

Off days & Holidays :- 02 days

Nature of Training :- Intensive Training in 'Mechanical, Auto Workshop'

REPORT OF TRAINING

	Excellent	Very Good	Good	Average
1. Conduct	✓			
2. Punctuality	✓			
3. Knowledge			✓	
4. Interview Rating			✓	
5. Report Rating		✓		

Special Remarks :-

Date :- 14.08.2021

Principal
Vishwaniketan's (IMEET)



For and on Behalf of R. C. F. Ltd.

TRUE COPY

राष्ट्रीय केमिकल्स एण्ड फर्टिलाइजर्स लिमिटेड



विश्वनिकेतन, अलिबाग, रायगड, महाराष्ट्र

मानव संसाधन विकास केंद्र

थळ इकाई, अलिबाग-रायगड-402 208

प्रमाणपत्र / Certificate

Name :- Mr. Pritesh Shanmukh Pingale

Institution :- Vishwaniketan, IMEET, Khalapur

Branch :- Mechanical Engineering

Period of Training :- 15 days from 16.07.2021 to 30.07.2021

Leave taken during training :- 00 days

Off days & Holidays :- 02 days

Nature of Training :- Intensive Training In 'Bagging Plant'

REPORT OF TRAINING

	Excellent	Very Good	Good	Average
1. Conduct	✓			
2. Punctuality	✓			
3. Knowledge			✓	
4. Interview Rating			✓	
5. Report Rating		✓		

Special Remarks :- _____

Date :- 30.07.2021

For and on Behalf of C. F. Ltd.

THE DIRECTOR OF INDUSTRIES
RAJYALAYA, PUNE (M. S.)
MAHARASHTRA GOVERNMENT
PUNE-411 004

TRUE COPY



Principal

Vishwaniketan's (I MEET)



Let us grow together

Rashtriya Chemicals and Fertilizers Limited.

Training Centre, Thal Unit, Tal. -Alibag, Dist- Raigad -402208 (MS)-India

Phone No. :- (02141) 238012 - 2080/9820560222/2195/8888722255

Ref No : Thal/TRG/AGM/VT- Mech./JSM-Alibag/June-21/(149)

Date : 07/7/2021

To,

Prof. Kishor V. Mane, Industry Internship Co-ordinator
Dept. of Mechanical Engg.
ViMEET, Khalapur
Survey No.-52, Kumbhivali, Near Khalapur Toll Naka,
Off Mumbai Pune Expressway
Tal.- Khalapur, Dist.- Raigad-410202 (MS)-India

SUB.:- In-plant training to Vocational Trainees (Deg- Mech. Engg.)

REF.: - Your letter/e.mail

Ref. No.:-ViMEET/Mech./IIT/08/20210630,0705 Dated- 30/06/21,5/7.

Dear Sir,

1. With reference to your letter/e-mail above, we would be happy to provide In-plant Training/Industrial Training/Internship facility to following 04 student/s from Deg. Mech. Engg. on acceptance of the terms and conditions mentioned below for 16/07/21 to 30/07/21 (15 days/2 weeks) 6 days a week & timing is 8 am to 5 pm.
(1) Mr. V.R. Mhatre (2) Mr. S.S.Wavekar (3) Mr. A.M.Patil (4) Mr. P.S. Pingale

Terms and Conditions

2. Training Charges Rs.1200/- (inclusive 18 % GST) per student up to one month by Demand Draft drawn only in favour of R. C. F. Ltd, payable at SBI Thal-Vaishet or Alibag.
3. Student/s must comply with the rules, regulations, discipline and timings stipulated during the training period by the company.
4. No stipend will be paid to the student/s & no availability of accommodation in RCF Guest House/Township.
5. We will extend our help to get an accommodation @ Rs.100/- per day per student in Holiday Homes on 5 to 6 students in one room basis (if required).
6. Student/s will bear medical charges if they receive medical treatment during their period with us.
7. Student/s should bring In-plant training/Industrial Training requirements to facilitate learning.
8. Student/s should bring three (3) passport size photograph & his /her/ their college Identity Card, while coming for training for the temporary gate pass arrangement.
9. Student/s should wear safety shoes during training period and bring umbrella & water bottle.
10. No camera or mobile camera is allowed in the factory premises during training period.
11. Student/s must follow the Government norms applicable in the present situation.

The above terms and conditions should be conveyed to the respective student/s before coming for the training.

Thanking You

Yours Faithfully

Principal
Vishwaniketan's (I MEET)

S/D.
(Dharmendra M. Ramteke)
Asst. General Manager (HRD)



TRUE COPY



Let us grow together

Rashtriya Chemicals and Fertilizers Limited.
Training Centre, Thal Unit, Tal. -Alibag, Dist- Raigad -402208 (MS)-India
Phone No. :- (02141) 238012 - 2080/9820560222/2195/8888722255

Ref No : Thal/HRD/AGM/VT- Mech..Engg./ViMEET-Khalapur/Dec-20/(34)

Date : 17/12/2020

To,

Prof. Sagar A. Dhotare
Internship Co-ordinator , Dept. of Mech. Engg.
ViMEET, Khalapur, Campus- Survey No.-52
Kumbhivali, Near Khalapur Toll Naka,
off Mumbai Pune Expressway, Tal.- Khalapur,
Dist- Raigad 410202 (MS)-India

SUB:- In-plant training to Vocational Trainees (Deg-Mech. Engg.)

REF:- Your letter/e.mail Ref. No.: ViMEET/AGM-5 /HRD/2020 21/11/220, dated 11/12/20

Dear Sir,

1. With reference to your letter/e-mail above, we would be happy to provide In-plant Training/Industrial Training/Internship facility to following **01 student/s** from Deg. in Chem. Engg. on acceptance of the terms and conditions mentioned below for **01/01/21 to 15/01/21** (15 days/2 Weeks) 6 days a week & timing is 8 am to 5 pm.

(1) Mr. Saurabh Sandip Salvi , BE-Mech.

Terms and Conditions

2. Training Charges **Rs.1200/-** (inclusive 18 % GST) per student upto one month by Demand Draft drawn only in favour of **R. C. F. Ltd, payable at SBI Thal-Vaishet or Alibag.**
3. Student/s must comply with the rules, regulations, discipline and timings stipulated during the training period by the company.
4. No stipend will be paid to the student/s & no availability of accommodation in RCF Guest House/Township.
5. We will extend our help to get an accommodation @ Rs.100/- per day per student in Holiday Homes on 5 to 6 students in one room basis (if required).
6. Student/s will bear medical charges if they receive medical treatment during their period with us.
7. Student/s should bring In-plant training/Industrial Training requirements to facilitate learning.
8. Student/s should bring three (3) passport size photograph & his /her/ their college Identity Card, while coming for training for the temporary gate pass arrangement.
9. Student/s should wear safety shoes during training period and bring umbrella & water bottle.
10. No camera or mobile camera is allowed in the factory premises during training period.
11. Student/s must follow the Government norms applicable in the present situation.

The above terms and conditions should be conveyed to the respective student/s before coming for the training.

Thanking You

Vishwaniketan's Institute of Management,
Entrepreneurship & Engineering Technology,

Inward No. 2116

Date: 19/12/2020

Yours Faithfully

(Dharmendra M. Kanteke)
Asst. General Manager (HRD)

Principal

Vishwaniketan's (I MEET)

To
Mr. Sagar Dhotare

18/12/2020

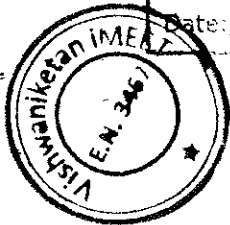

TRUE COPY



VISHWANIKETAN'S
Institute of Management Entrepreneurship & Engineering Technology [iMEET]

Affiliated to University of Mumbai, Approved by AICTE, New Delhi

DTE CODE NO. EN: 3467

Survey No. 52, Khumbhivali, Near Khalapur Toll Naka, off. Mumbai-Pune Expressway, Tal. - Khalapur,
Dist - Raigad - Pin - 410 202 Telephone - 02192 - 274 206/07/08/10 Fax - 02192 - 274 210

Dr. Ramjee Prasad
Hon Chairman

Mr. Sunil Bangar
Secretary

Dr. B. R. Patil
Principal

Ref. No. : ViMEET /IV/ CE/ 3187/2018-19

Date: 06/09/2018

To,

Subject: Permission for visit the Water treatment plant at Khopoli for
Academic Purpose.

Respected Sir,

We would hereby like to arrange an educational visit of our T.E. (A&B) Civil Engineering student to the Water treatment plant at Khopoli for study various technical things of Environmental engineering. The purpose of visit is purely academic. The total number of students visiting the site will be 130 and they will be accompanied by 4 faculty.

Vishwaniketan is a public trust established by professionals drawn from the industry, education and administration with excellent experience in the respective fields. The campus has been located near Navi Mumbai, at Khalapur on Mumbai- Pune expressway. This has created platform for students, teachers, researchers and professionals to adopt excellent teaching - learning practices based on project Based Learning (PBL). This will encourage entrepreneurship and finally support product-development through start-ups and empower teachers and the society by technology-solutions.

Please kindly Grant permission for visit.

Thanking you.

Accepted
Approved on
Monday
Dt. 10.9.18
Shivaji

शशि सुरेश जयवंत,
कोषी नगरपालिका,
Head

Department of Civil Engg

Head of Department

Civil Engineering

Vishwaniketan's iMEET



Principal
Vishwaniketan's (iMEET)

Principal
Principal (Dr. B. R. Patil)
VI-MEET

Principal
Vishwaniketan's (iMEET)

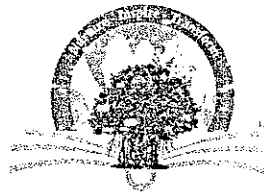

VISHWANIKETAN'S

Institute of Management Entrepreneurship & Engineering Technology [iMEET]

Affiliated to University of Mumbai, Approved by AICTE, New Delhi

DTE CODE NO. EN:3467

Survey No. 52, Khumbhivali, Near Khalapur Toll Naka, off. Mumbai-Pune Expressway, Tal. - Khalapur,
Dist - Raigad - Pin - 410 202 Telephone - 02192 - 274 206/07/08/10 Fax - 02192 - 274 210

Dr. Ramjee Prasad
Hon. Chairman

Mr. Sunil Bangar
Secretary

Dr. B. R. Patil
Principal

Ref. No. : ViMEET / Thanks / 3154 / 2018-19

Date: 10/09/2018

To,
Water department
Nagarपालिका
Rhapoli
410203

Subject: Thanking letter.

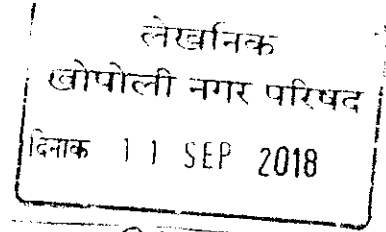

Respected Sir,

We are very grateful for sparing your valuable time for guiding our Third Year students of Civil Engineering at your water treatment plant. This will definitely provide right path towards the goal. Your resourceful interaction with the Civil Engineering students will definitely prove increase in their Knowledge.

We thank you once again for your full co-operation. Look forward for more such interactions in future.

Thanking you.

HOD
Civil Dept.
Head of Department
Civil Engineering
Vishwaniketan's iMEET



Head of Department
Civil Engineering
Vishwaniketan's iMEET

Principal
Vishwaniketan's iMEET

Principal
Vishwaniketan's iMEET

VISHWANIKETAN'S Institute of Management
& Engineering Technology
T.E.(CIVIL) Sem VI- (2018-19)
SUBMISSION SHEET

Subject : FE-II

Dr. Heens Jain

Sr. No.	Roll Call	Student Name	Signature
1	B01	MHATRE PRATIK BHANUDAS	<u>[Signature]</u>
2	B02	MOHITE MANSEE MOHAN	<u>[Signature]</u>
3	B03	MOKAL HARSHADA VISHVANATH	<u>[Signature]</u>
4	B04	MOKAL PRAJWAL SUNIL	<u>[Signature]</u>
5	B05	MOKAL SHUBHAM SANTOSH	<u>[Signature]</u>
6	B06	MOTE TEJAS CHANDRAKANT	<u>[Signature]</u>
7	B07 D	MUJAWAR SALMAN TASLIM	<u>[Signature]</u>
8	B08	MUKKU PRASANTHA KUMAR V REDDY	<u>[Signature]</u>
9	B09	MULEY PRANAY TEJRAO	<u>[Signature]</u>
10	B10	NAGDIVE NIVESH SUDHIR (VAP) TPO	<u>[Signature]</u>
11	B11	NAIK JAYESH CHANDRAKANT	<u>[Signature]</u>
12	B12	NARANGIKAR HARSHADA	<u>[Signature]</u>
13	B13	NAVALE SANJEEVANI SURYAKANT	<u>[Signature]</u>
14	B14	OJHA SANJEEV KUMAR	<u>[Signature]</u>
15	B15	OSWAL DUSHANT MANISH (VAP)	<u>[Signature]</u>
16	B16	PADWANKAR SAURABH SANJAY	<u>[Signature]</u>
17	B17	PANDHARE RUSHIKESH DNYANDEV TPO	<u>[Signature]</u>
18	B18	PATIL AARTI PRALHAD	<u>[Signature]</u>
19	B19	PATIL JAYESH MOHAN	<u>[Signature]</u>
20	B20	PATIL KEDAR SHARAD	<u>[Signature]</u>
21	B21	PATIL OMKAR KISHOR	<u>[Signature]</u>
22	B22	PATIL OMKAR MADHUKAR	<u>[Signature]</u>
23	B23	PATIL PRATIKSHA	<u>[Signature]</u>
24	B24 D	PATIL RAHUL SURESH TPO	<u>[Signature]</u>
25	B25	PATIL RATNESH RAMKANT	<u>[Signature]</u>
26	B26	PATIL SAYLI ANIL	<u>[Signature]</u>

Head of Department
Civil Engineering
Vishwaniketan's iMEET

Principal
Vishwaniketan's (iMEET)





Sr. No.	Roll Call	Student Name	Signature
27	B27	PATIL SAYLI KISHOR	
28	B28	PATIL SHUBHAM MOHAN	
29	B29	PATIL TEJAL VASUDEV	
30	B30	PATIL TEJASWINI VIKAS	
31	B31	PATIL UMANG DHANAJI	
32	B32	PAWAR ASHUTOSH SHIVAJI TPO	
33	B33	PETHE ANIKIT R.	
34	B34	PINGALE ROHINI SANTOSH	
35	B35	POKHARKAR NILESH RAMDAS	
36	B36	PUNYARTHI RUSHIKESH SADANAND	
37	B37	RANGARI VIPUL DEVENAND	
38	B38	SAITAWADEKAR SAURABH RAMESH	
39	B39	SALAVI DARSHAN MANOHAR	
40	B40	SALVI PRASENJIT RAJESH	
41	B41	SANAP ABHISHEK SHAILESH	
42	B42	SAPKAL PIYUSH RAJESH	
43	B43	SATVE AKASHAY ANANTA	
44	B44	SAVALE BHUPESH HIMMTRAO	
45	B45	SAWANT CHIRAG DEEPAK (VAP)	
46	B46	SAWANT PRATIK JAGDISH	
47	B47	SHAH VISHESH SANDEEP	
48	B48	SHARMA VIKASH MANOJ	
49	B49	SHETYE RIDDHI ASHISH MANSI	
50	B50	SHINDE ANKITA	
51	B51	SHINDE NIKHIL RAMESH TPO	
52	B52	SHINDE VISHAL PRAKASH	
53	B53	SHIRKE ASHITOSH SURESH	
54	B54	SINGHI SANJU ARUNKUMAR	
55	B55	SURYAWANSHI SIDDHANT BANDOPANT (TPO)	
56	B56	THAKUR ABHISHEK ANIL	
57	B57	THAKUR OMKAR ANAND (VAP)	

Head of Department
Civil Engineering
Vishwaniketan's iMEET

Principal
Vishwaniketan's (iMEET)

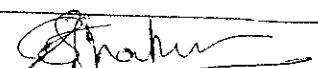
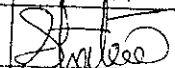
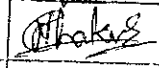
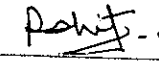
3

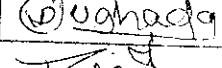
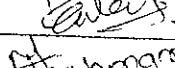
CGSA

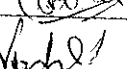
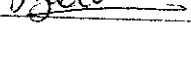
Sr. No.	Roll Call	Student Name	Signature
58	B58	THAKUR SARVESH CHANDRASHEKHAR	
59	B59	THAKUR SHILPA NARAYAN	
60	B60	THAKUR VAIBHAV PURUSHOTTAM	
61	B61	THORAT ROHIT KISHOR	
62	B62	THUBE PRATIKSHA GITARAM	
63	B63	UGHADA VILAS DURGADAS	
64	B64	WAGH PANKAJ BALU	
65	B65	WAGHMARE BHAGYASHRI MOHAN	
66	B66	WAKADE SNEHAL PRADEEP	
67	B67	WANALEKAR VARSHA HANUMANTRAO	
68	B68	YADAV NIRANJAN VITTHAL	

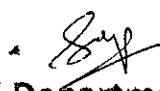
Head of Department
 Civil Engineering
 Vishwaniketan's iMEET

Principal
 Vishwaniketan's (iMEET)



12

VISHWANIKETAN'S
Institute of Management Entrepreneurship & Engineering Technology [i MEET]
Affiliated to University of Mumbai, Approved by AICTE, New Delhi

DTE CODE NO. EN: 3467

Survey No. 52, Khumbhivali, Near Khalapur Toll Naka, off. Mumbai-Pune Expressway, Tal. - Khalapur,
Dist - Raigad - Pin - 410 202 Telephone - 02192 - 274 206/07/08/10 Fax - 02192 - 274 210

Dr. Ramjee Prasad
Hon Chairman

Mr. Sunil Bangar
Secretary

Dr. B. R. Patil
Principal

Ref. No. : ViMEE 1 / Visit / CE -452/2019-20

Date : 17/09/2019

To,
Sub. Engineer,
Madhuban Dam,
Silvassa.

Subject: Permission for Madhuban Dam.

Respected Sir,

We would hereby like to request you to give permission for the visit of our Third Year Civil Engineering Students to the Madhuban Dam on 20th, 21st Sept. 2019. This visit surely will be beneficial to our students to increase their knowledge and to get practical approach of subject.

Vishwaniketan is a public trust established by professionals drawn from the industry, education and administration with excellent experience in the respective fields. The campus has been located near Navi Mumbai, at Khalapur on Mumbai- Pune expressway. This has created platform for students, teachers, researchers and professionals to adopt excellent teaching – learning practices based on project Based Learning (PBL). This will encourage entrepreneurship and finally support product-development through start-ups and empower teachers and the society by technology-solutions.

Thanking you.

Prof. Pallavi Dongare
Subject Coordinator

Prof. Shilpa Deshpande
H.O.D Civil Dept
Head of Department
Civil Engineering
Vishwaniketan's iMEET

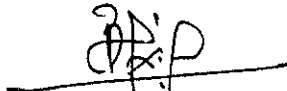
Dr. B.R. Patil
Principal, ViMEET



TRUE COPY



Date- 13/09/2019

To,
The Principal,
ViMEET, Khalapur

Subject- Permission letter for Site Visit

Respected Sir,

As you know Site visits are the integral part of curriculum, I am writing this letter to you for getting your permission to conduct site visit under the subject of Applied Hydraulics of TE Civil (A & B) to Madhuban dam, Silvasa.

We are planning this site visit on 20 & 21 Sept 2019 with approx. 100 students and concern 4 teaching faculties.

Please give us permission and do the needful for the same.

Thank you in anticipation.

Yours faithfully,

~~Prof. Pallavi Dongare~~
13/9/19
Asst. professor,
Civil Department
ViMEET

forwarded to principal sir

8/9
13/9/19



permitted

(Dr. B. R. Patil)

TRUE COPY

Dr. P

Vishwaniketan
Institute of Management Entrepreneurship and
Department : Civil Engineering
Class : BE Semester : VII (2019-20)

Sr No.	Name of Students	sign
A01	AMBADE VISHAKHA VINOD	
A02	AWALE SUPRIYA SITARAM	
A03	BENDRE BHAGYASHREE RAVINDRA	
A04	BHASE PRANAL RAMBHAJI	
A05	BHILARE SURAJ PRAKASH	
A06	BHOIR SHUBHAM HEMANT	
A07	BHOPI ROHAN RAGHUNATH	
A08	CHAVAN SANKET SURESH	
A09	CHAVAN VIKAS NAMDEV PURLABAI	
A10	CHIMANE SANKET SANTOSH	
A11	CHITTE GAURAV VIKAS	
A12	DANDEKAR MILAN LALIT	
A13	DEOKAR YOGESH PITAMBAR	
A14	DESAI MANGESH PANDURANG	
A15	DESHMUKH MAYURI SANJAY.	
A16	DESHMUKH SANKET BAPURAO	
A17	DHENDE MAYUR SIDDHARTH	
A18	GADGE AKASH BABAJI	
A19	GAIKWAD HARSHADA POPAT	
A20	GAVHANE RUSHIKESH NAMDEO	
A21	GAWADE ROHIT DEVAPPA	
A22	GAWAND NINAD RAVINDRA	
A23	GAWANDE SANJANA SHAILESH	
A24	GHANATE HARSHAL BABURAO	
A25	GHANGHAV HARSHVARDHAN MUKUND	
A26	GHARAT PRADNYA YASHAVANT	
A27	GODE ABHISHEK JAYDEEP	
A28	GURAV ADITYA ADESH	
A29	HEKRE SNEHAL SHARAD	
A30	JADHAV AKASH ARUN	
A31	JADHAV ANIKET SATISH	
A32	JADHAV SAMEER RAJENDRA	
A33	JADHAV SWARAJ JAYANT	
A34	JOSHI UDAY MAHESH	
A35	KADAM NIKHIL RAMA	
A36	KALE PRADEEP RAMCHANDRA	
A37	KANTHALE SHUBHAM	
A38	KARNUK VRUSHALI RAMBHAJI	

TRUE COPY

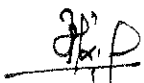

 Principal
 Vishwaniketan's (I MEET)

A39	KAVALE SAURABH SURESH	
A40	KHAN SAJID AFZAL	
A41	KHEDEKAR SANKALP SHARAD	
A42	KHUTLE PRATIKESH	
A43	KOKARE VISHAL BALU	
A44	KOLI ROHAN JANGAN	
A45	KOTHEKAR JANHAVI DATTATRAY	
A46	KULKARNI KAUSTUBH SACHIN	
A47	KULKARNI PARAG ANANT	
A48	KULKARNI SAMEER MAHESH	
A49	KURANGALE KIRAN KRUSHNA	
A50	MADANE NANDINI DILIP	
A51	MADHAVI CHAITANYA KISHOR	
A52	MADHAVI TANMAY DNYANE	
A53	MADKE DARSHAN BHARAT	
A54	MADKE MRUNAL MALHARI	
A55	MAHABALE SATYAVAN VISHWANATH	
A56	MAHADIK CHAITANYA CHANDRAKANT	
A57	MAHARNUR SURAJ ARUN	
A59	MALI SAGAR SANTOSH	
A61	MHATRE BHUSHAN VISHWANATH	
A62	MHATRE DIKSHITA BALIRAM	
B01	MAGAR PRADNESH	
B02	MHATRE NISHANT CHANDRASHEKHAR	
B03	MHATRE PRATIK BHANUDAS	
B04	MHATRE SIDDHANT SANJAY	
B05	MHATRE VIPUL SHRIPAT	
B06	MOHITE MANSEE MOHAN	
B07	MOKAL HARSHADA VISHVANATH	
B08	MOKAL PRAJWAL SUNIL	
B09	MOKAL SHUBHAM SANTOSH	
B10	MORE PRADEEP SHRIRAM	
B11	MUJAWAR SALMAN TASLIM	
B12	MUKKU PRASANTHA KUMAR V REDDY	
B13	NAGDIVE NIVESH SUDHIR	
B14	NAIK JAYESH CHANDRAKANT	
B15	NARANGIKAR HARSHADA	
B16	NAVALE SANJEEVANI SURYAKANT	
B17	OJHA SANJEEV KUMAR	
B18	OSWAL DUSHANT MANISH	
B19	PADWANKAR SAURABH SANJAY	
B20	PANDHARE RUSHIKESH DNYANDEV	
B21	PATIL AARTI PRALHAD	
B22	PATIL HARSHAD RAMDAS 0	

TRUE COPY



[Signature]
Principal
Vishwaniketan's (I) MEET

B23	PATIL KEDAR SHARAD	
B24	PATIL OMKAR KISHOR	
B25	PATIL OMKAR MADHUKAR	
B26	PATIL PRATIK NARAYAN	
B27	PATIL PRATIKSHA YASHVANT	
B28	PATIL RATNESH RAMKANT	
B29	PATIL SAYLI ANIL	
B30	PATIL SAYLI KISHOR	
B31	PATIL SHUBHAM MOHAN	
B32	PATIL TEJAL VASUDEV	
B33	PATIL TEJASWINI VIKAS	
B34	PATIL UMANG DHANAJI	
B35	PETHE ANIKIT RAJENDRA	
B36	PINGALE ROHINI SANTOSH	
B37	POKHARKAR NILESH RAMDAS	
B38	RANGARI VIPUL DEVENAND	
B39	SAITAWADEKAR SAURABH RAMESH	
B40	SALUNKHE SWAPNIL RAJU	
B41	SALVI PRASENJIT RAJESH	
B42	SANAP ABHISHEK SHAILESH	
B43	SAPKAL PIYUSH RAJESH	
B44	SARDESAI DIGVIJAY	
B45	SATVE AKASHAY ANANTA	
B46	SAVALE BHUPESH HIMMTRAO	
B47	SAWANT CHIRAG DEEPAK	
B48	SAWANT PRATIK JAGDISH	
B49	SHAH VISHESH SANDEEP	
B50	SHAIKH REHMAN SAB	
B51	SHARMA VIKASH MANOJ	
B52	SHETE NIKHIL NIVIN	
B53	SHINDE ANKITA PRASHANT	
B54	SHINDE VISHAL PRAKASH	
B55	SHIRKE ASHITOSH SURESH	
B56	SINGH SANJU ARUNKUMAR	
B57	SURYAWANSHI SIDDHANT BANDOPANT	
B58	THAKUR ABHISHEK ANIL	
B59	THAKUR OMKAR ANAND	
B60	THAKUR SARVESH CHANDRASHEKHAR	
B61	THAKUR SHILPA NARAYAN	
B62	THAKUR VAIBHAV PURUSHOTTAM	
B63	THAKUR VRUSHAL RAJESH	
B64	THUBE PRATIKSHA GITARAM	
B65	THUBE ANIKET ANANTA	
B66	UGHADA VILAS DURGADAS	

TRUE COPY



[Handwritten Signature]

Principal
Vishwaniketan's (I) MEET

Vishwaniketan
Institute of Management Entrepreneurship and
Department : Civil Engineering
Class : BE Semester : VII (2019-20)

Sr No.	Name of Students	sign
A01	AMBADE VISHAKHA VINOD	<u>V Ambade</u>
A02	AWALE SUPRIYA SITARAM	<u>S Awale</u>
A03	BENDRE BHAGYASHREE RAVINDRA	<u>B Bendre</u>
A04	BHASE PRANAL RAMBHAJI	<u>B Bhasre</u>
A05	BHILARE SURAJ PRAKASH	<u>B Bhilare</u>
A06	BHOIR SHUBHAM HEMANT	A
A07	BHOPI ROHAN RAGHUNATH	A
A08	CHAVAN SANKET SURESH	<u>S Chavan</u>
A09	CHAVAN VIKAS NAMDEV PURLABAI	A
A10	CHIMANE SANKET SANTOSH	<u>Chimane</u>
A11	CHITTE GAURAV VIKAS	A
A12	DANDEKAR MILAN LALIT	<u>M Dandekar</u>
A13	DEOKAR YOGESH PITAMBAR	A
A14	DESAI MANGESH PANDURANG	<u>M Desai</u>
A15	DESHMUKH MAYURI SANJAY.	A
A16	DESHMUKH SANKET BAPURAO	A
A17	DHENDE MAYUR SIDDHARTH	<u>May Dende</u>
A18	GADGE AKASH BABAJI	A
A19	GAIKWAD HARSHADA POPAT	A
A20	GAVHANE RUSHIKESH NAMDEO	A
A21	GAWADE ROHIT DEVAPPA	<u>Gawade</u>
A22	GAWAND NINAD RAVINDRA	A
A23	GAWANDE SANJANA SHAIKESH	A
A24	GHANATE HARSHAL BABURAO	A
A25	GHANGHAV HARSHVARDHAN MUKUND	A
A26	GHRAT PRADNYA YASHAVANT	<u>Gharat</u>
A27	GODE ABHISHEK JAYDEEP	A
A28	GURAV ADITYA ADESH	A
A29	HEKRE SNEHAL SHARAD	A
A30	JADHAV AKASH ARUN	A
A31	JADHAV ANIKET SATISH	<u>A Jadhav</u>
A32	JADHAV SAMEER RAJENDRA	A
A33	JADHAV SWARAJ JAYANT	A
A34	JOSHI UDAY MAHESH	<u>Joshi</u>
A35	KADAM NIKHIL RAMA	A
A36	KALE PRADEEP RAMCHANDRA	<u>Kale</u>
A37	KANTHALE SHUBHAM	A
A38	KARNUK VRUSHALI RAMBHAJI	<u>V Karnuk</u>

TRUE COPY



Principal
Principal
Vishwaniketan (IMET)

B67	WAGH PANKAJ BALU	
B68	WAGHMARE BHAGYASHRI MOHAN	
B69	WAKADE SNEHAL PRADEEP	
B70	THORAT ROHIT KISHOR	

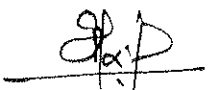

TRUE COPY

Vishwaniketan's (iMEET)

B67	WAGH PANKAJ BALU	<i>Pankaj</i>
B68	WAGHMARE BHAGYASHRI MOHAN	<i>Bhagyan</i>
B69	WAKADE SNEHAL PRADEEP	A
B70	THORAT ROHIT KISHOR	A



TRUE COPY

[Signature]
Principal
Vishwaniketan's (i MEET)

B23	PATIL KEDAR SHARAD	Patil
B24	PATIL OMKAR KISHOR	Omkar
B25	PATIL OMKAR MADHUKAR	Omkar
B26	PATIL PRATIK NARAYAN	Pratik
B27	PATIL PRATIKSHA YASHVANT	Pratiksha
R28	PATIL RATNESH RAMKANT	Ratnesh
B29	PATIL SAYLI ANIL	Sayli
B30	PATIL SAYLI KISHOR	Sayli
B31	PATIL SHUBHAM MOHAN	Shubham
B32	PATIL TEJAL VASUDEV	Tejal
B33	PATIL TEJASWINI VIKAS	Tejashini
B34	PATIL UMANG DHANAJI	Umang
B35	PETHE ANIKIT RAJENDRA	Pethe
B36	PINGALE ROHINI SANTOSH	Pingale
B37	POKHARKAR NILESH RAMDAS	Nilesh
B38	RANGARI VIPUL DEVENAND	Vipul
B39	SAITAWADEKAR SAURABH RAMESH	Saitawadekar
B40	SALUNKHE SWAPNIL RAJU	Swapnil
B41	SALVI PRASENJIT RAJESH	Salvi
B42	SANAP ABHISHEK SHAILESH	A
B43	SAPKAL PIYUSH RAJESH	A
B44	SARDESAI DIGVIJAY	Sardesai
B45	SATVE AKASHAY ANANTA	A
B46	SAVALE BHUPESH HIMMTRAO	A
B47	SAWANT CHIRAG DEEPAK	Sawant
B48	SAWANT PRATIK JAGDISH	A
B49	SHAH VISHESH SANDEEP	A
B50	SHAIKH REHMAN SAB	Shah
B51	SHARMA VIKASH MANOJ	A
B52	SHETE NIKHIL NIVIN	A
B53	SHINDE ANKITA PRASHANT	A
B54	SHINDE VISHAL PRAKASH	Shinhal
B55	SHIRKE ASHITOSH SURESH	A
B56	SINGH SANJU ARUNKUMAR	A
B57	SURYAWANSHI SIDDHANT BANDOPANT	Suryawanshi
B58	THAKUR ABHISHEK ANIL	A
B59	THAKUR OMKAR ANAND	A
B60	THAKUR SARVESH CHANDRASHEKHAR	A
B61	THAKUR SHILPA NARAYAN	Shilpa
B62	THAKUR VAIBHAV PURUSHOTTAM	A
B63	THAKUR VRUSHAL RAJESH	Vrushal
B64	THUBE PRATIKSHA GITARAM	A
B65	THUBE ANIKET ANANTA	A
B66	UGHADA VILAS DURGADAS	Ughada



TRUE COPY

[Signature]

Principal

Vishwaniketan's (M.E.E.T)

A39	KAVALE SAURABH SURESH	Saurabh
A40	KHAN SAJID AFZAL	A
A41	KHEDEKAR SANKALP SHARAD	A
A42	KHUTLE PRATIKESH	SANKALP
A43	KOKARE VISHAL BALU	A
A44	KOLI ROHAN JANGAN	A
A45	KOTHEKAR JANHAVI DATTATRAY	A
A46	KULKARNI KAUSTUBH SACHIN	A
A47	KULKARNI PARAG ANANT	Parag
A48	KULKARNI SAMEER MAHESH	A
A49	KURANGALE KIRAN KRUSHNA	A
A50	MADANE NANDINI DILIP	Nandani
A51	MADHAVI CHAITANYA KISHOR	A
A52	MADHAVI TANMAY DNYANE	Tanmay
A53	MADKE DARSHAN BHARAT	A
A54	MADKE MRUNAL MALHARI	A
A55	MAHABALE SATYAVAN VISHWANATH	A
A56	MAHADIK CHAITANYA CHANDRAKANT	Mahadik
A57	MAHARNUR SURAJ ARUN	A
A59	MALI SAGAR SANTOSH	Sagar
A61	MHATRE BHUSHAN VISHWANATH	A
A62	MHATRE DIKSHITA BALIRAM	A
B01	MAGAR PRADNESH	A
B02	MHATRE NISHANT CHANDRASHEKHAR	A
B03	MHATRE PRATIK BHANUDAS	A
B04	MHATRE SIDDHANT SANJAY	A
B05	MHATRE VIPUL SHRIPAT	Vipul
B06	MOHITE MANSEE MOHAN	A
B07	MOKAL HARSHADA VISHVANATH	A
B08	MOKAL PRAJWAL SUNIL	Mokal
B09	MOKAL SHUBHAM SANTOSH	Mokal
B10	MORE PRADEEP SHRIRAM	More
B11	MUJAWAR SALMAN TASLIM	Salman
B12	MUKKU PRASANTHA KUMAR V REDDY	A
B13	NAGDIVE NIVESH SUDHIR	Nagdi
B14	NAIK JAYESH CHANDRAKANT	Naik
B15	NARANGIKAR HARSHADA	A
B16	NAVALE SANJEEVANI SURYAKANT	A
B17	OJHA SANJEEV KUMAR	Ojha
B18	OSWAL DUSHANT MANISH	Dosway
B19	PADWANKAR SAURABH SANJAY	A
B20	PANDHARE RUSHIKESH DNYANDEV	A
B21	PATIL AARTI PRALHAD	Aarti
B22	PATIL HARSHAD RAMDAS	A



TRUE COPY

[Signature]
Principal
Vishwaniketan's (I) MEET



VISHWANIKETAN'S
Institute of Management Entrepreneurship & Engineering Technology [i MEET]
Affiliated to University of Mumbai, Approved by AICTE, New Delhi

DTE CODE NO. EN: 3467

Survey No. 52, Khumbhivali, Near Khalapur Toll Naka off, Mumbai-Pune Expressway, Tal. - Khalapur,
Dist - Raigad - Pin - 410 202 Telephone - 02192 - 274 206/07/08/10 Fax - 02192 - 274 210

Dr. Ramjee Prasad
Hon Chairman

Mr. Sunil Bangar
Secretary

Dr. B. R. Patil
Principal

ViMEET/Civil Engineering/IV/234/2017-18

Date: 07th Feb2018

To,

Mr. Sanjay Nadgeri
Deputy General Manager,
J.M. Mhatre Infrastructure. Pvt.Ltd.
Indapur (NAHI), Panvel
Maharashtra -410206

Subject: Permission for visit of Retaining structure & Bridge Design.

Respected Sir,

We would hereby like to arrange an educational visit for our T.E.Civil Engineering student to **RETAINING STRUCTURE & BRIDGE DESIGN** at Indapur (NHAI) section NH-17 Panvel location to study various technical things of reinforcement details and construction of prestressed structure as per syllabus of TRPC & Geotechnical Engineering. The total number of students visiting the site will be 110 and they will be accompanied by 4 faculty.

Vishwaniketans is a public trust established by professionals drawn from the industry, education and administration with excellent experience in the respective fields. The campus has been located near Navi Mumbai, at Khalapur on Mumbai- Pune expressway. This has created platform for students, teachers, researchers and professionals to adopt excellent teaching – learning practices based on project Based Learning (PBL).This will encourage entrepreneurship and finally support product-development through start-ups and empower teachers and the society by technology-solutions.

Please kindly Grant permission for visit.

Thanking you.

HOD

Department of Civil Engg



Principal

TRUE COPY

Vishwaniketans
Institute of Management Entrepreneurship
& Engineering Technology (iMEET)

Principal



U

VISHWANIKETAN'S
Institute of Management Entrepreneurship & Engineering Technology [i MEET]
Affiliated to University of Mumbai, Approved by AICTE, New Delhi

DTE CODE NO. EN: 3467

Survey No. 52, Khumbhivali, Near Khalapur Toll Naka, off. Mumbai-Pune Expressway, Tal. - Khalapur,
Dist - Raigad - Pin - 410 202 Telephone - 02192 - 274 206/07/08/10 Fax - 02192 - 274 210

Dr. Ramjee Prasad
Hon Chairman

Mr. Sunil Bangar
Secretary

Dr. B. R. Patil
Principal

ViMEET / Civil /2343/2017-18

Date : 07/02/2018

To,
Mr. Sanjay Nadgeri
Deputy General Manager,
J.M. Mhatre Infrastructure. Pvt.Ltd.
Indapur (NAHI), Panvel
Maharashtra -410206

Respected Sir,

We are very grateful for sparing your valuable time for guiding the Third year students of civil Engineering at your site. This will definitely provide right path towards the goal. Your resourceful interaction with the Civil Engineering students, on 8th Feb, 2018, will definitely prove valuable, in fulfilment in their Knowledge.

We thank you once again for your full co-operation. Look forward for more such interactions.

Thanking you.

Principal

Vishwaniketan's i-MEET
Principal
Vishwaniketan's
Institute of Management Entrepreneurship
& Engineering Technology (iMEET)

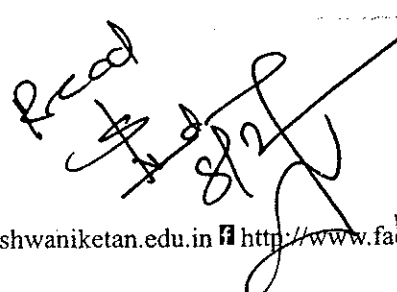

TRUE COPY

Recd
8/2/18



Principal

Faculty Name :

Sr. No.	NAME OF THE STUDENT	1	2	3	4	5	6	7	8	9	10	11
A01	AUTADE KUNAL BHAUSAHEB VIDYA											
A02	BADE ASHWINI AJNATH PRAVARA	Aswini	Aswini									
A03	BADE ROSHAN JAGDISH MEERA											
A04	BHOIR SHUBHAM HEMANT											
A05	BHOITE VARSHA NATHA SUMAN	Varsha	Varsha									
A06	CHAUDHARI BHARAT SUNIL KIRTI	Bharat	Bharat									
A07	CHAVAN GOVIND SUBHASH MUNNI	G.S.C	G.S.C									
A08	CHOWDHARI CHINMAY PRAMOD	C.P.C	C.P.C									
A09	DESHMANE SAHITYA RATANLAL RAJANI											
A10	DESHMUKH SANKET BAPURAO SARIKA	Sanket	Sanket									
A11	DHENDE MAYUR	Mayur	Mayur									
A12	DHONGADE SANDEHYA DHANANJAY	Sandhya	Sandhya									
A13	DUDUSKAR ROHAN SURESH SUCHITA	Rohan	Rohan									
A14	GAIKWAD HARSHADA POPAT	Harshada	Harshada									
A15	GANDAGE SHANKAR	Shankar	Shankar									
A16	GHARAT KUNAL JAYDEV	Kunal	Kunal									
A17	GHARAT VIKRAM SUBHASH	Vikram	Vikram									
A18	HEKRE SNEHAL	Snehal	Snehal									
A19	INGOLE VIJAY DASHRATH	Vijay	Vijay									
A20	JADHAV AKSHAY ASHOK MEENAKSHI	Akshay	Akshay									
A21	JADHAV AKSHAY BABURAO											
A22	JADHAV JIVAN KRISHNA JAYSHREE	Jivan	Jivan									
A23	JADHAV NISHANT SHANTARAM JAYSHREE	Nishant	Nishant									
A24	JAGDALE AMIT LAHURAJ	Amit	Amit									

TRUE COPY



[Signature]
 Principal
 Vishwaniketan's (A) DEPT

Sr. No.	NAME OF THE STUDENT	1	2	3	4	5	6	7	8	9	10	11
A25	JAIHWAL VIJAYLAXMI RAMANAND ASHA	<i>Jaiwal</i>	<i>Jaiwal</i>									
A26	JHA DEEPAK SUSHILKUMAR											
A27	JONDHALE SOHAM SHAIENDRA	<i>Sonahale</i>	<i>Sonahale</i>									
A28	KAMBLE KRUTIKA											
A29	KARANDE MAHESH NANDKUMAR SNEHA											
A30	KASHID PRADIP SHIVAJI MEENA											
A31	KHARSAMBALE SONIYA HEMNATH MINAXI	<i>Soniya</i>	<i>Soniya</i>									
A32	KIRVE PRATHAMESH SUNIL RAJASHREE											
A33	KOLI SATYAJEET HARIDAS ROHINI	<i>Koli</i>	<i>Koli</i>									
A34	KURANKAR ANKITA SHREEDHAR	<i>Ankita</i>	<i>Ankita</i>									
A35	MAGAR PRADNESH PRAFULL	<i>Prad</i>	<i>Prad</i>									
A36	MALI SAGAR											
A37	MANE SUMIT	<i>Mane</i>	<i>Mane</i>									
A38	MASANE KAPIL MANGAL	<i>Kapil</i>	<i>Kapil</i>									
A39	MATHE PRACHI SUNIL	<i>Prachi</i>	<i>Prachi</i>									
A40	MHATRE CHHAYA SUBHASH SHUBHANGI	<i>Chhaya</i>	<i>Chhaya</i>									
A41	MHATRE NIKHIL KAILASH	<i>Nikhil</i>	<i>Nikhil</i>									
A42	MHATRE PRAJKATA PRABHAKAR	<i>Pra</i>	<i>Pra</i>									
A43	MHATRE SAMIR SANJAY											
A44	MORE PRADIP SHRIRAM	<i>Pradip</i>	<i>Pradip</i>									
A45	MORE VISHAKHA RAMCHANDRA UJWALA											
A46	PATIL ANIKET ARUN NANDA	<i>Aniket</i>	<i>Aniket</i>									
A47	PATIL DIPIL VIJAY	<i>Dipil</i>	<i>Dipil</i>									
A48	PATIL NAMRATA	<i>Namr</i>	<i>Namr</i>									
A49	PATIL NIVRUTTI ANKUSH	<i>Nivp</i>	<i>Nivp</i>									
A50	PATIL PRACHIT PRAMOD											
A51	PATIL PRANAV PRABHAKAR	<i>P.P.P</i>	<i>P.P.P</i>									
A52	PATIL RAHUL TUKARAM											
A53	PATIL RUPALI VASUDEV	<i>Rupali</i>	<i>Rupali</i>									

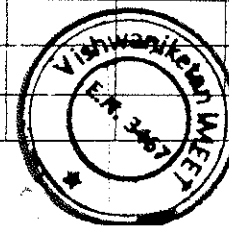

TRUE COPY

[Signature]
Principal
Vishwaniketan's (i MEET)

Sr. No.	NAME OF THE STUDENT	1	2	3	4	5	6	7	8	9	10	11
A54	PATIL SAGAR SANDEEP SMITA	<i>Sagar</i>	<i>Smita</i>									
A55	PAWAR KALYANI DIGAMBAR	<i>Kalyani</i>	<i>Digambar</i>									
A56	RANE VISHWADH PRASHANT MEGHA	<i>Vishwadh</i>	<i>Megha</i>									
A57	RAUT YOGESH RAJENDRA											
A58	REDDY SONIA RAKESH	<i>Sonia</i>	<i>Rakesh</i>									
A59	RUPANVAR AKASH DATTU											
A60	SALUNKHE SWAPNIL	<i>Swapnil</i>										
A61	SANGE SUSHANT SANTOSH SANGEETA	<i>Sushant</i>	<i>Sangeeta</i>									
A62	SHAHASANE DURVESH UDAYKUMAR	<i>Durvish</i>										
A63	SHAIKH RAHEMAN	<i>Rahman</i>										
A64	SHETE NIKHIL NAVIN	<i>Nikhil</i>										
A65	SHINDE SHUBHAM											
A66	SHIRKE KRUTIKA KISAN	<i>Krutika</i>	<i>Kisan</i>									
A67	SONAWANE SHUBHAM HIRALAL											
A68	SURVASE PRATIK DHANRAJ ANITA											
A69	TAMAKHE MANGESH BIRA KAMAL	<i>Mangesh</i>	<i>Kamal</i>									
A70	THAKUR VRUSHAL RAJESH	<i>Vrushal</i>										
A71	TUPE ANIKET ANANTA											
A72	VAGHANI PARTH DEVSHI											
A73	WAGHMARE ABHIJIT SUNIL	<i>Abhijit</i>	<i>Sunil</i>									
A74	WASKAR PRATHAMESH KISHOR											
A75	YADAV RAJ DEEPAK											

TRUE COPY

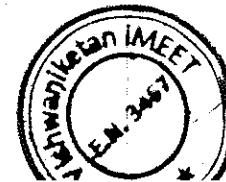

[Signature]
Principal
Vishwaniketan's (I MEET)

To
Vishwaniketan VIMEET
(Estate Dept)
Khalapur

Sub :- Regarding Bus availability for IV
of Civil Students (TE) to JSW
Wadkhal pen

Respected sir,

We got a permission for industrial visit
to JSW Wadkhal pen on 08/02/18. We are
going to pen around 10:00 AM. From VIMEET
campus & return back at 4:00 PM & total
No. of students are around 110 so kindly
arrange the bus facility

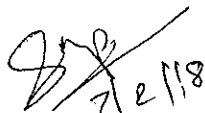
7/2/18
HOD

Civil Department

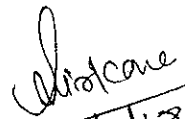

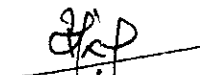
07/2/18
(C.S.P. Hirekane)

(A.R. Patil)

TRUE COPY

PRINCIPAL
VIMEET

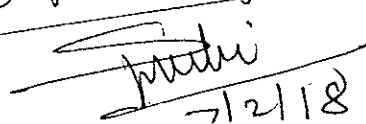

Two buses allowed
to PEN (JSW)

7/2/18

Industrial Visit Feedback Form

(Please specify Industrial Visit information by descriptive statement, tables, sketches, figures i.e., add Extra sheet)

Name of Student **SHIVRAJ C CHAVAN**

Course and Branch **CIVIL ENGRG. / VIth sem.**

Roll No. **10. (B DIV)**

Name and Address of Industrial Visit Organization **VADKHAL - BRIDGE CONSTRUCTION SITE.**

1. State two important experiences that had been gained from the industrial Visit :

1. We had experienced good site knowledge about how actually construction site works.

2. Experienced about safety, detailing, How to read engineering drawing.

Overall good experience

2. Main problems encountered during the industrial Visit:

problem might had occur about safety, but it didn't. So, No any problem encountered.

3. How do you evaluate your overall training Visit?

Excellent



Satisfactory



Not satisfactory



4. Types of exposure given:

Area Interest	Please specified
Design	Detailing about reinforcement
Analysis	
Outdoor work	
Supervision	safety, work, done.
Administration	
Daily work	

Your satisfaction level after Industrial Visit (only tick): (5: highest; 1: lowest)

✓	✓	✓	✓	✓
---	---	---	---	---

Signature with Date

Shivraj C Chavan 25

TRUE COPY

Principal

Principal

Vishwaniketan's (i MEET)



Industrial Visit Feedback Form

(Please specify Industrial Visit information by descriptive statement, tables, sketches, figures i.e., add Extra sheet)

Name of Student Megha Laxman Shandge

Course and Branch En B.E. Civil

Roll No. B-52

Name and Address of Industrial Visit Organization Vadkhal (Pen)

1. State two important experiences that had been gained from the industrial Visit :

Retaining wall
knowledge of prestressed concrete

2. Main problems encountered during the industrial Visit:

In the construction piers obstacle
of reliance gas line

3. How do you evaluate your overall training Visit?

Excellent



Satisfactory



Not satisfactory



4. Types of exposure given:

Area Interest	Please specified
Design	<u>Steel Fe500 (Excellent)</u>
Analysis	<u>Concrete 35</u>
Outdoor work	<u>-</u>
Supervision	<u>-</u>
Administration	<u>J.M. MHATRE</u>
Daily work	<u>Yes</u>

Your satisfaction level after Industrial Visit (only tick): (5: highest; 1: lowest)

<input checked="" type="checkbox"/>	<input type="checkbox"/>	<input type="checkbox"/>	<input type="checkbox"/>	<input type="checkbox"/>
-------------------------------------	--------------------------	--------------------------	--------------------------	--------------------------

M Shandge 6.4.18
Signature with Date

TRUE COPY

J.M. MHATRE
Principal
Vishwaniketan's (I MEET)



Industrial Visit Feedback Form

(Please specify Industrial Visit information by descriptive statement, tables, sketches, figures i.e., add Extra sheet)

Name of Student Varsha D. Patil

Course and Branch Civil Engg.

Roll No. 48

Name and Address of Industrial Visit Organization :- (Wadkhali) Retaining wall & Prestressed concrete.

1. State two important experiences that had been gained from the industrial Visit :

1) We get whole idea about the bridge construction.

2) We get information about prestressed component or beam. How they cast the prestressed beam.

2. Main problems encountered during the industrial Visit:

.....

3. How do you evaluate your overall training Visit?

Excellent Satisfactory Not satisfactory

4. Types of exposure given:

Area Interest	Please specified
Design	Excellent
Analysis	
Outdoor work	
Supervision	
Administration	
Daily work	

Your satisfaction level after Industrial Visit (only tick): (5: highest; 1: lowest)

Patil
 Signature with Date 6/04/18

TRUE COPY

[Signature]
 Principal
 Vishwaniketan's (i MEET)



Industrial Visit Feedback Form

(Please specify Industrial Visit information by descriptive statement, tables, sketches, figures i.e., add Extra sheet)

Name of Student TAMGADGE SNIKET SNIL

Course and Branch THIRD YEAR CIVIL

Roll No. 57

Name and Address of Industrial Visit Organization J. M. MAHATRE INFRA - WADKHAL

1. State two important experiences that had been gained from the industrial Visit :

1. process of whole bridge construction.
2. safety precaution taken at site for various activities.

2. Main problems encountered during the industrial Visit:

1. Hindrance to the project work :
 - ⓐ GAIL - gas line
 - ⓑ Local issues

3. How do you evaluate your overall training Visit?

Excellent



Satisfactory



Not satisfactory



4. Types of exposure given:

Area Interest	Please specified
Design	Excellent
Analysis	
Outdoor work	
Supervision	
Administration	
Daily work	

Your satisfaction level after Industrial Visit (only tick): (5: highest; 1: lowest)

✓	✓	✓	✓	✓
---	---	---	---	---

Signature with Date
[Signature] 06/02/18



TRUE COPY

[Signature]
Principal
Vishwaniketan's (I MEET)

Industrial Visit Feedback Form

(Please specify Industrial Visit information by descriptive statement, tables, sketches, figures i.e., add Extra sheet)

Name of Student Harshada Gajendra patil

Course and Branch CIVIL (T.E)

Roll No. 43

Name and Address of Industrial Visit Organization Retaining wall, prestress bridge ; Vadkhal

1. State two important experiences that had been gained from the industrial Visit :

1) It was certainly a great experience and highly surprising to see all the technical and practical knowledge and study on the retaining wall and prestressed bridge.

2. Main problems encountered during the industrial Visit:

Nothing & in problems but for some local issues created.

3. How do you evaluate your overall training Visit?

Excellent Satisfactory Not satisfactory

4. Types of exposure given:

Area Interest	Please specified
Design	Steel frame (excellent)
Analysis	concrete 35
Outdoor work	—
Supervision	J.M. metatre —
Administration	yes J.M metatre
Daily work	yes

Your satisfaction level after Industrial Visit (only tick): (5: highest; 1: lowest)

Signature with Date



TRUE COPY

 Principal
 Vishwaniketan's (I) MEET

Industrial Visit Feedback Form

(Please specify Industrial Visit information by descriptive statement, tables, sketches, figures i.e., add Extra sheet)

Name of Student - Girish P. Patil

Course and Branch - TE - Civil - B

Roll No. 41

Name and Address of Industrial Visit Organization J.M. Mhatre Construction - Vadkhal

1. State two important experiences that had been gained from the industrial Visit :

1) I got to know about construction of retaining wall for bridge.

2) Procedure of placing girder (Pre-cast)

2. Main problems encountered during the industrial Visit:

Underground gas line of Reliance Industries

3. How do you evaluate your overall training Visit?

Excellent



Satisfactory



Not satisfactory



4. Types of exposure given:

Area Interest	Please specified
Design	-
Analysis	-
Outdoor work	Yes
Supervision	
Administration	J.M. Mhatre
Daily work	Yes

Your satisfaction level after Industrial Visit (only tick): (5: highest; 1: lowest).

			✓	
--	--	--	---	--

G.Patil
6/4/18
Signature with Date



TRUE COPY

G.P.
Principal
Vishwaniketan's (I MEET)



VISHWANIKETAN'S
Institute of Management Entrepreneurship & Engineering Techno.
Affiliated to University of Mumbai, Approved by AICTE, New Delhi

DTE CODE NO. EN: 3467

Survey No. 52, Khumbhivali, Near Khalapur Toll Naka, off. Mumbai-Pune Expressway, Tal. - Kha
Dist - Raigad - Pin - 410 202 Telephone - 02192 - 274 206/07/08/10 Fax - 02192 - 274 210

Dr. Ramjee Prasad
Hon Chairman

Mr. Sunil Bangar
Secretary

Dr. B. R. Patil
Principal

Ref. No. : VIMEET / CE / Ind. Visit 2393 / 2017-18

Date : 09/03/2018

To,
Chief Engineer,
Tata Power Valvan Dam,
Lonavala.

Subject : Regarding Permission for site visit and Survey of Canal.

Respected Sir/Madam,

Vishwaniketan is a public trust established by professionals drawn from the industry, education and administration with excellent experience in the respective fields. The campus has been located near Navi Mumbai, at Khalapur on Mumbai- Pune expressway. This has created platform for students, teachers, researchers and professionals to adopt excellent teaching - learning practices based on project Based Learning (PBL). This will encourage entrepreneurship and finally support product-development through start-ups and empower teachers and the society by technology-solutions.

Under above vision we are committed to provide practical exposure to our students.

We would hereby like to request you to give permission to our Third year Civil Engineering Students for visit and survey of Valvan Dam, Lonavala, Pune. We have two divisions with strength of 60 each, hence we required two days for visit and survey. Any two dates between 15th and 16th March, 2018 are feasible to us. Please confirm any two dates. This visit and survey work surely will be beneficial to our students to increase their knowledge and to get practical approach of subject.

We will obliged if you help in this regards.

Thanking you.

HOD
H.O.D. Civil Dept.

Received

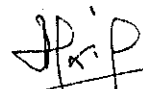

Principal
VIMEET
(Dr. B. R. Patil)



TRUE COPY



VISHWANIKETAN
Institute of Management Entrepreneurship & Engineering Technology [iMEET]
Affiliated to University of Mumbai, Approved by UETE, New Delhi

DTE CODE NO. EN: 3467

Survey No. 52, Khumbhivali, Near Khalapur Toll Naka, off. Mumbai-Pune Expressway, Tal. - Khalapur,
Dist - Raigad - Pin - 410 202 Telephone - 02192 - 274 206/07/08/10 Fax - 02192 - 274 210

Dr. Ramjee Prasad
Hon Chairman

Mr. Sunil Bangar
Secretary

Dr. B. R. Patil
Principal

Ref. No. : ViMEET / Thanks /2354- / 2017-18

Date : 16/03/2018

To,
Chief Engineer,
Tata Power Valvan Dam,
Lonavala.

Subject : Thanking letter.

Respected Sir,

We are very grateful for sparing your valuable time for guiding our Third Year students of Civil Engineering at your Valvan Dam, Lonavala, Pune. This will definitely provide right path towards the goal. Your resourceful interaction with the Civil Engineering students will definitely prove increase in their Knowledge.

We thank you once again for your full co-operation. Look forward for more such interactions in future.

Thanking you.

HOD
Civil Dept.



Principal
ViMEET

TRUE COPY



VISHWANIKETAN

VISHWANIKETAN'S

INSTITUTE OF MANAGEMENT ENTREPRENEURSHIP AND ENGINEERING TECHNOLOGY

T.E. CIVIL (SEM-VI)

AY 2017-18

(A DIV)

Industrial Visit

16/03/18

ROLL CALL LIST

DEPARTMENT OF CIVIL ENGINEERING

Faculty Name :

16/3/18.

Sr. No.	NAME OF THE STUDENT	1	2	3	4	5	6	7	8	9	10	11
A01	AUTADE KUNAL BHAUSAHEB VIDYA	Kunal										
A02	BADE ASHWINI AJNATH PRAVARA	Ashwini										
A03	BADE ROSHAN JAGDISH MEERA	Roshan										
A04	BHOIR SHUBHAM HEMANT	A										
A05	BHOITE VARSHA NATHA SUMAN	Varsha										
A06	CHAUDHARI BHARAT SUNIL KIRTI	Bharat										
A07	CHAVAN GOVIND SUBHASH MUNNI	Govind										
A08	CHOWDHARI CHINMAY PRAMOD	A										
A09	DESHMANE SAHITYA RATANLAL RAJANI	Sahitya										
A10	DESHMUKH SANKET BAPURAO SARIKA	Sanket										
A11	DHENDE MAYUR	Mayur										
A12	DHONGADE SANDHYA DHANANJAY	Sandhya										
A13	DUDUSKAR ROHAN SUKESH SUCHITA	A										
A14	GAIKWAD HARSHADA POPAT	Harshada										
A15	GANDAGE SHANKAR	Shankar										
A16	GHARAT KUNAL JAYDEV	Kunal										
A17	GHARAT VIKRAM SUBHASH	Vikram										
A18	HEKRE SNEHAL	Snehal										
A19	JINGOLE VIJAY DASHRATH	Vijay										
A20	JADHAV AKSHAY ASHOK MEENAKSHI	Akshay										
A21	JADHAV AKSHAY BABURAO	Akshay										
A22	JADHAV JIVAN KRISHNA JAYSHREE	Jivan										
A23	JADHAV NISHANT SHANTARAM JAYSHREE	Nishant										
A24	JAGDALE AMIT LAHURAJ	Amit										

TRUE COPY



Principal
Vishwaniketan's (IIMFT)

Sr. No.	NAME OF THE STUDENT	1	2	3	4	5	6	7	8	9	10	11
A25	JAISWAL VIJAYLAXMI RAMANAND ASHA	<i>Jaiswal</i>										
A26	JHA DEEPAK SUSHILKUMAR	<i>A</i>										
A27	JONDHALE SOHAM SHAILENDRA											
A28	KAMBLE KRUTIKA	<i>Kamble</i>										
A29	KARANDE MAHESH NANDKUMAR SNEHA	<i>Karan</i>										
A30	KASHID PRADIP SHIVAJI MEENA	<i>Kashid</i>										
A31	KHARSAMBALE SONIYA HEMNATH MINAXI	<i>A</i>										
A32	KIRVE PRATHAMESH SUNIL RAJASHREE	<i>Prathav</i>										
A33	KOLI SATYAJEET HARIDAS ROHINI	<i>Koli</i>										
A34	KURANKAR ANKITA SHREEDHAR	<i>Ankita</i>										
A35	MAGAR PRADNESH PRAFULL	<i>Prad</i>										
A36	MALI SAGAR	<i>Sagar</i>										
A37	MANE SUMIT	<i>Mane</i>										
A38	MASANE KAPIL MANGAL	<i>Kapil</i>										
A39	MATHE PRACHI SUNIL	<i>Prachi</i>										
A40	MHATRE CHHAYA SUBHASH SHUBHANGI	<i>Chhaya</i>										
A41	MHATRE NIKHIL KAILASH	<i>Nikhil</i>										
A42	MHATRE PRAJKATA PRABHAKAR	<i>Prabhakar</i>										
A43	MHATRE SAMIR SANJAY	<i>Samir</i>										
A44	MORE PRADIP SHRIRAM	<i>Pradip</i>										
A45	MORE VISHAKHA RAMCHANDRA UJWALA	<i>Vishakha</i>										
A46	PATIL ANIKET ARUN NANDA	<i>A</i>										
A47	PATIL DIPIL VIJAY	<i>A</i>										
A48	PATIL NAMRATA											
A49	PATIL NIVRUTTI ANKUSH											
A50	PATIL PRACHIT PRAMOD	<i>Nivru</i>										
A51	PATIL PRANAV PRABHAKAR	<i>Prachit</i>										
A52	PATIL RAHUL TUKARAM	<i>A</i>										
A53	PATIL RUPALI VASUDEV	<i>Rupali</i>										



TRUE COPY

[Signature]
Principal

Vishwaniketan's (I MEET)

Sr. No.	NAME OF THE STUDENT	1	2	3	4	5	6	7	8	9	10	11
A54	PATIL SAGAR SANDEEP SMITA	<i>Sagar</i>										
A55	PAWAR KALYANI DIGAMBAR	<i>Kalyani</i>										
A56	RANE VISHWADH PRASHANT MEGHA	<i>Vishwadh</i>										
A57	RAUT YOGESH RAJENDRA	<i>Yogesh</i>										
A58	REDDY SONIA RAKESH	A										
A59	RUPANVAR AKASH DATTU	<i>Rupans</i>										
A60	SALUNKHE SWAPNIL	A										
A61	SANGE SUSIANT SANTOSH SANGEETA	A										
A62	SHAHASANE DURVESH UDAYKUMAR	<i>Durvesh</i>										
A63	SHAIKH RAHEMAN	<i>Raheman</i>										
A64	SHETE NIKHIL NAVIN	<i>Nikhil</i>										
A65	SHINDE SHUBHAM	A										
A66	SHIRKE KRUTIKA KISAN	<i>Krutika</i>										
A67	SONAWANE SHUBHAM HIRALAL	<i>Shubham</i>										
A68	SURVASE PR/ TIK DHANRAJ ANITA	A										
A69	TAMAKHE MANGESH BIRA KAMAL	<i>Mangesh</i>										
A70	THAKUR VRUSHAL RAJESH	A										
A71	TUPE ANIKET ANANTA	A										
A72	VAGHANI PARTH DEVSHI	<i>Parth</i>										
A73	WAGHMARE ABHIJIT SUNIL	<i>Abhijit</i>										
A74	WASKAR PRATHAMESH KISHOR	A										
A75	YADAV RAJ DEEPAK	A										



TRUE COPY

[Signature]
Principal
Vishwaniketan's (I MEET)



39

Industrial Visit

VISHWANIKETAN'S
INSTITUTE OF MANAGEMENT ENTREPRENEURSHIP AND ENGINEERING TECHNOLOGY
T.E. CIVIL (SEM-VI) AY 2017-18 (B DIV)

15/3/18

ROLL CALL LIST

DEPARTMENT OF CIVIL ENGINEERING

BATCH I

Faculty Name :

Sr. No.	NAME OF THE STUDENT	1	2	3	4	5	6	7	8
B01	AHINAVE NIKHIL JALINDAR								
B02	AMIRK HAN ABDUL RASID	A							
B03	AWARGAND VISHAL LAXMAN	✓							
B04	BARASKAR DEVAYANI DNYANESHWAR	✓							
B05	BHAGAT ACHAL VIJAY SARITA	A							
B06	BHALEKAR AKSHAY SUBHASH	✓							
B07	BHANGALE HEMANT PRAMOD	✓							
B08	BHOIR VIJAY JAGANNATH	A							
B09	BIRADAR AMAR SHRIKANT VIDYA	✓							
B10	CHAVAN SHIVRAJ CHANDRAKANT	✓							
B11	CHAVAN UJJWAL PRAKASH	✓							
B12	CHAWAN RAKESH ROHIDAS	✓							
B13	CHEPATE RUSHIKESH GAHININATH	✓							
B14	DESHMUKH SURAJ CHANDRAKANT	✓							
B15	DHAMANE SANDESH SHEKHER	✓							
B16	DHOBLE OMKAR RAMCHANDRA	✓							
B17	GAIKWAD SWAPNIL SURYAKANT	✓							
B18	GAIKWAD SIDDHESH BHARAT	✓							
B19	GAMARE SAGAR SUBHASH	✓							
B20	GHANGHAV HARSHVARDHAN MUKUND	✓							

TRUE COPY

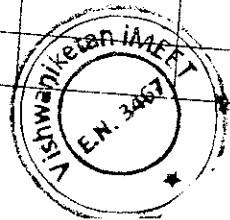

[Signature]
Principal

Vishwaniketan's (iMEET)

GANGAPUR DAM REPORT

Bhatsa Dam, is an earthfill and gravity dam on Bhatsa river near Shahapur, district-thane in the state of Maharashtra in India.

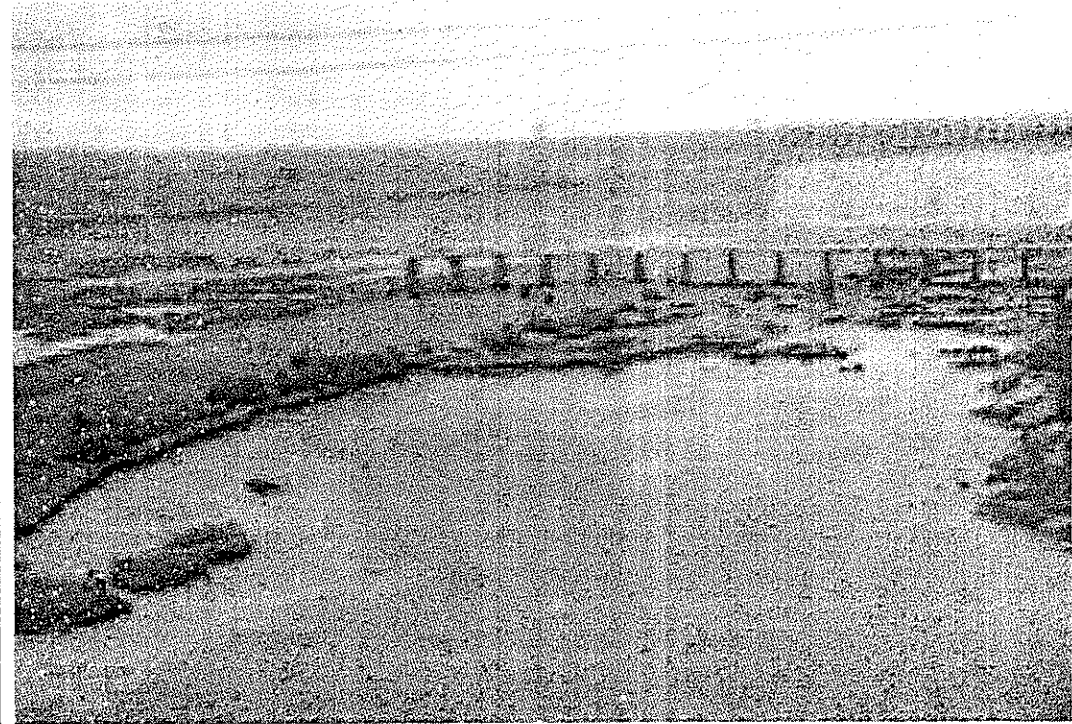
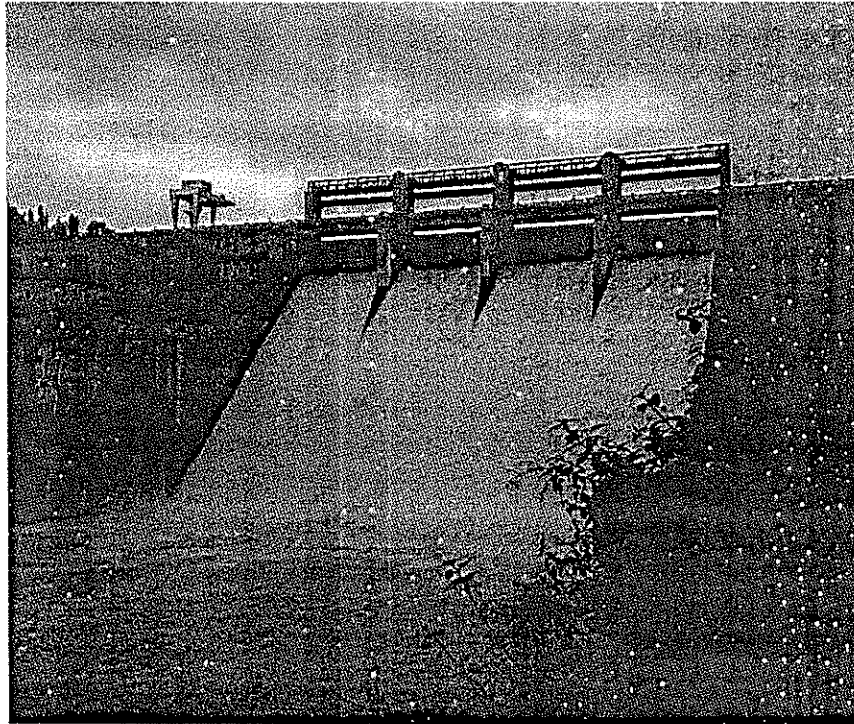

TRUE COPY

J.P.

Principal

GANGAPUR DAM

Official name :- Gangapur dam

Location :- Nashik

Opening date :- 1954

Owner(s) :- Government of maharashtra (india)

Lattitude & Longitude :-20.048 and 73.679

DAMS AND SPILLWAYS

Types of dams :-Earthen dam

Height :-36.59

Lengths :-3,902m

Dam volume :-4612km³

Reservoir

Total capacity :-0.2038km³

surface area :-22,860km²

**TRUE COPY**

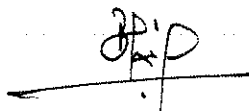
Principal
Vishwaniketan's (i MEET)

SPECIFICATION

The height of the dam above lowest foundation is 36.59m while the length is 3902m (3146ft). The volume content is 4612km³ and gross storage capacity is 0.2038km³ .

gangapur dam was constructed by (MTDC) Maharashtra tourism development corporation

PURPOSE

Gangapur dan also provides irrigation water. hence desilting should be explored seriously. during the current 2012 to 2013 drought, gov. had undertaken denslting of some reseroirs in maharashtra.

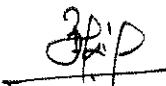

TRUE COPY

Principal
Vishwaniketan's (I MEET)

EARTHEN DAM

Earthen dam is also called as embankment dam or earth fill dam. These dams are constructed with natural materials like clay, gravel, sand & silt. Earthen dams are constructed by compacting successive layer of earth, using the most impervious materials to form a core more permeable substances on upstream & downstream side. Dam is constructed nearly as trapezoidal cross section. Earthen dam resists the forces exerted upon it mainly due to shear strength of soil. Although the weight of the structure also helps resisting forces. Earth dams are built on any type of foundation.

MATERIALS FOR EARTHEN DAM:

Earthen dam requires large quantities of materials. Earthen dam can be designed to fulfill its functions satisfactorily with any type of material available. The following materials are commonly used for construction of earthen dams:

- Sandy materials
- Rock
- Clayed materials
- Sand
- Cement, steel, lime and other building materials are used in small quantities for construction of spillway, outlets etc.

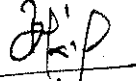

TRUE COPY

Principal
Vishwaniketan's (i MEET)

TYPES OF EARTHEN DAM:

1. HOMOGENEOUS EMBANKMENT TYPE:

A purely homogeneous type earth dam is composed of single kind of material. They are used only for low heights. A purely homogeneous section has been replaced by modified homogeneous section in which in drainage system in the form of horizontal drain filter is provided. This controls action of seepage so as to provide steeper slopes. These dams are composed of impervious or semi-impervious soils to provide an adequate

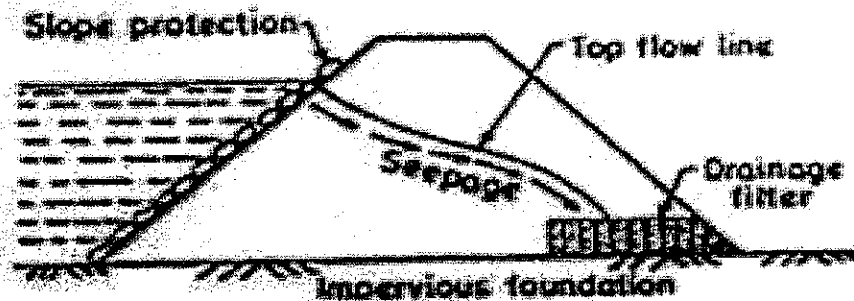

Homogeneous embankment provided with a drainage filter.

2. ZONED EMBANKMENT TYPE:

Zone embankment type earth dam is the one in which the dam is made up of more than one material. The dam is provided with a central impervious core, covered by a pervious transition zone. A suitable drainage system of horizontal drain or rock toe is also provided at downstream side. Outer shells are made of pervious, free draining materials. The shells give stability to the central impervious fill and at the same time distribute load over a larger area of foundation.

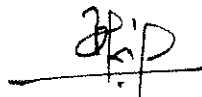

TRUE COPY

Principal
Vishwaniketan's (I) MEET

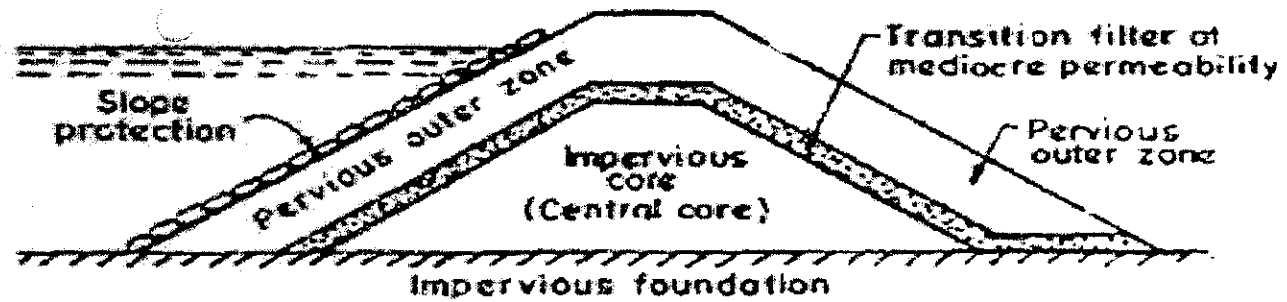

3. DIAPHRAGM EMBANKMENT TYPE:

In diaphragm embankment type, embankment is constructed of pervious material and thin diaphragm of impermeable material is provided to check the seepage. The diaphragm may be of impervious soil, cement concrete, bituminous concrete or any other material and may be placed either central vertical core

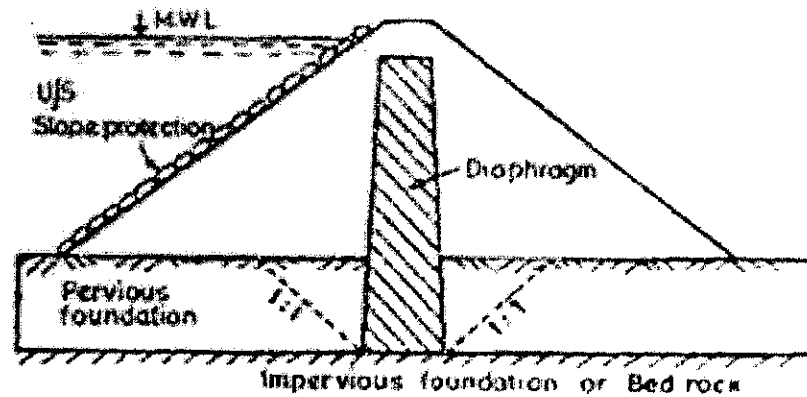

TRUE COPY

[Signature]

Principal
Vishwaniketan's (i MEET)

COMPONENT PARTS OF EARTHEN DAM:

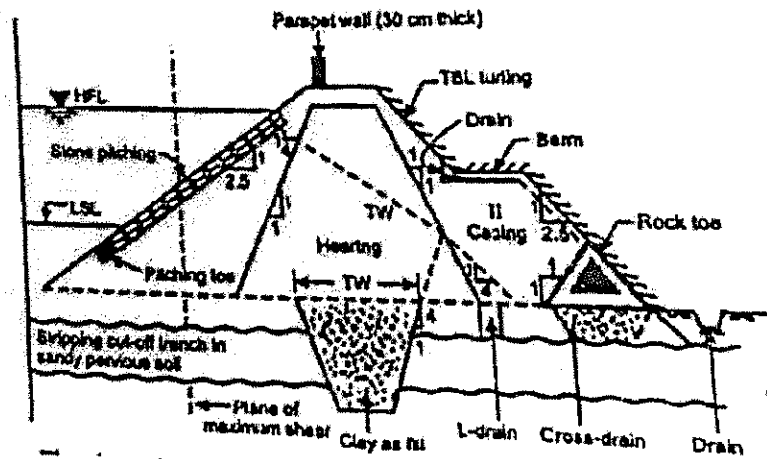

1. **Hearing (core):** It forms the central impervious section built with clayey soil, silt loam, etc. It provides water tightness to the dam and adequate shear resistance against slipping. Controls s body of dam.
2. **Casing:** It forms outer portion of dam built with murum, soft rock or sand & gravel. It provides cover to th protecting it from cracking. Provide stability to dam.
3. **Cut-off trench:** It is excavated below ground level under the hearing zone & filled with clayey soil. Its function is to prevent seepage flow through pervious foundation. It prevents piping of c foundation.
4. **Rock toe:** It is constructed from rock pieces or boulders large than 20cm size. I helps to prevent sloughing of toe due to seepage flow.



TRUE COPY

[Signature]
Principal
Vishwaniketan's (i MEET)

CONDITIONS OF STABILITY OF EARTHEN DAM:

1. The dam should not be overtopped by flood water.
2. The seepage line should be within the downstream face of the dam.
3. The upstream and downstream face should be stable under worst conditions.
4. The foundation shear stresses should be within the safe limit.
5. There should be no opportunity for free flow of water from upstream to downstream.
6. The upstream slope should be protected from wave action.
7. The dam and foundation should be safe against piping.

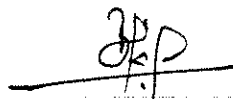

TRUE COPY

Principal
Vishwaniketan's (i MEET)

GRAVITY DAM

A Gravity dam has been defined as a "structure which is designed in such a way that its own weight resists external forces". A gravity dam is a dam constructed from concrete or stone masonry and designed to hold back water by using only the weight of the material and its resistance against the foundation to oppose the horizontal pressure of water pushing against it.

TYPES OF GRAVITY DAM:

Gravity dam are classified according to the material used for constructing them.

- 1. MASONRY DAM:** This type of dam is constructed with masonry which could be either of rubble or coursed masonry.
- 2. CONCRETE DAM:** They are constructed block by block by pouring good quality concrete

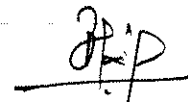

TRUE COPY

Principal

Vishwaniketan's (I) EET

COMPONENT PARTS OF GRAVITY DAM:

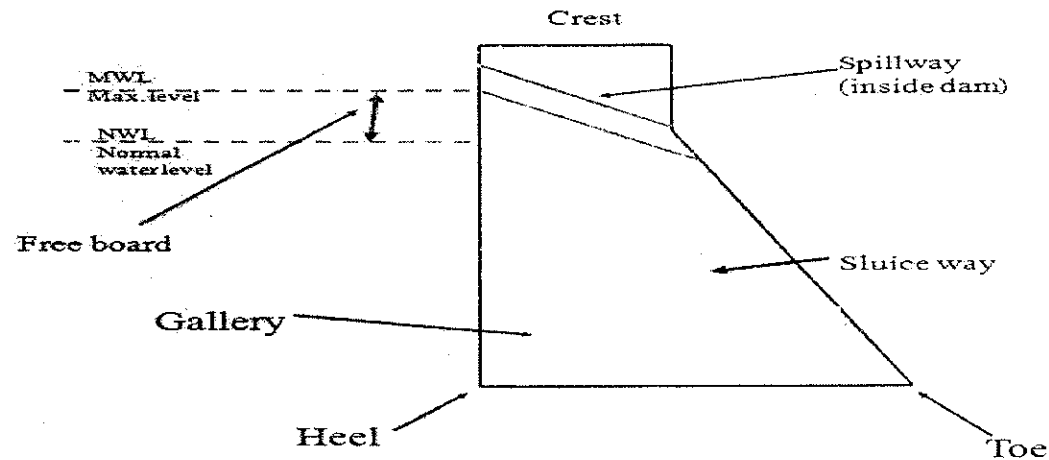

1. Heel-contact with the ground on the upstream side.
2. Toe-contact with the ground on the upstream side
3. Abutment-Sides of the valley on which the structure of the dam rest.
4. Galleries-small rooms like structure left within the dam for checking operations
5. Spillway-It is the arrangement near the top to release the excess water of the reservoir to downstream
6. Sluice Way-An opening in the dam near the ground level, which is used to clear the silt, accumulation reservoir side.
7. Divergen tunnel-Tunnels are constructed for diverting water before the construction of dam. This help the river bed dry.



TRUE COPY

Principal
Vishwaniketan's (IMET)

GANGAPUR DAM REPORT

Bhatsa Dam, is an earthfill and gravity dam on Bhatsa river near Shahapur, district-thane in the state of Maharashtra in India.

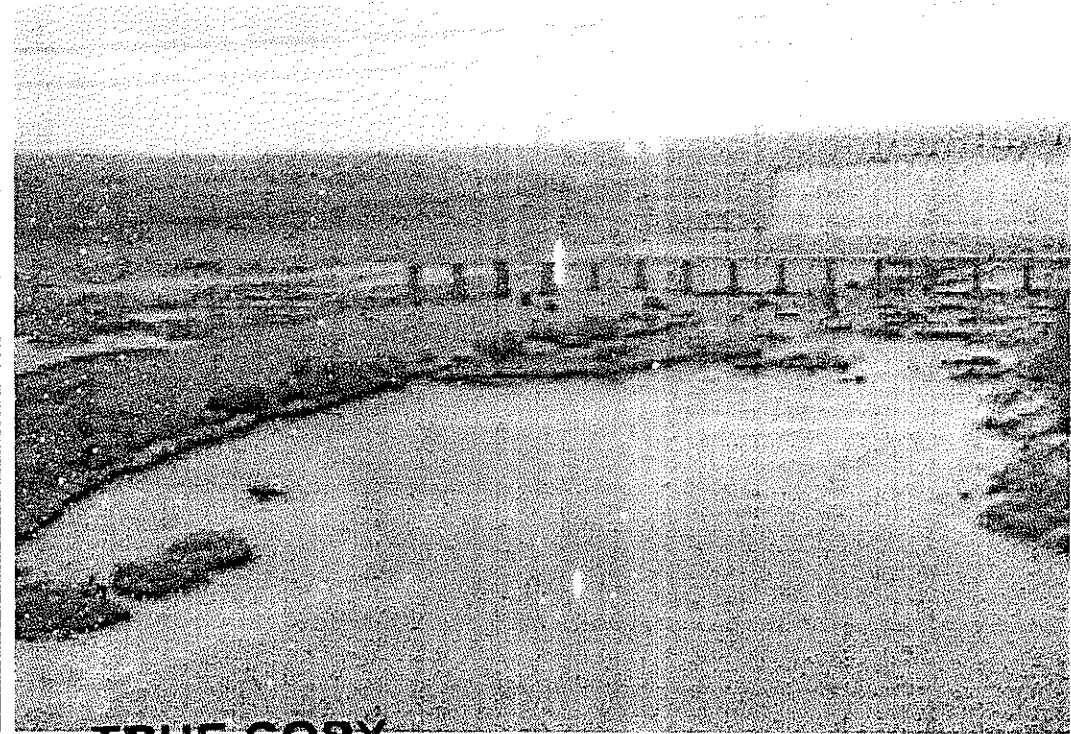
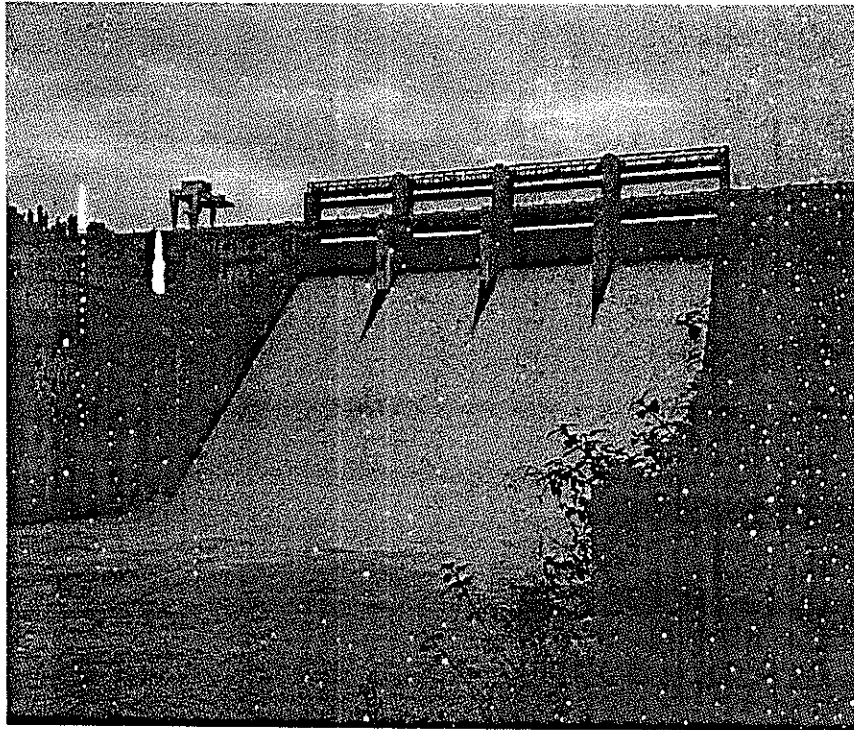

TRUE COPY

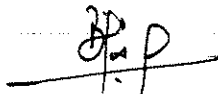

Principal
Vishwaniketan's (i MEET)

GANGAPUR DAM

Official name	:- Gangapur dam
Location	:- Nashik
Opening date	:- 1954
Owner(s)	:- Government of maharashtra (india)
Lattitude & Longitude	:-20.048 and 73.679

DAMS AND SPILLWAYS

Types of dams	:-Earthen dam
Height	:-36.59
Lengths	:-3,902m
Dam volume	:-4612km ³

Reservoir

Total capacity	:-0.2038km ³
surface area	:-22,860km ²

TRUE COPY

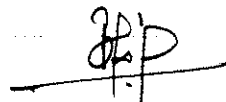

Principal
Vishwaniketan's (i MEET)

SPECIFICATION

The height of the dam above lowest foundation is 36.59m while the length is 3902m (3146ft). The volume content is 4612km³ and gross storage capacity is 0.2038km³ .

gangapur dam was constructed by (MTDC) Maharashtra tourism development corporation

PURPOSE

Gangapur dan also provides irrigation water. hence desilting should be explored seriously. during the current 2012 to 2013 drought, gov. had undertaken denslting of some reseroirs in maharashtra.



TRUE COPY

Principal
Vishwaniketan's (i MEET)

EARTHEN DAM

Earthen dam is also called as embankment dam or earth fill dam. These dams are constructed with natural materials like clay, gravel, sand & silt. Earthen dams are constructed by compacting successive layer of earth, using the most impervious materials to form a core more permeable substances on upstream & downstream side. Dam is constructed nearly as trapezoidal cross section. Earthen dam resists the forces exerted upon it mainly due to shear strength of soil. Although the weight of the structure also helps resisting forces. Earth dams are built on any type of foundation.

MATERIALS FOR EARTHEN DAM:

Earthen dam requires large quantities of materials. Earthen dam can be designed to fulfill its functions satisfactorily with any type of material available. The following materials are commonly used for construction of earthen dams:

- Sandy materials
- Rock
- Clayed materials
- Sand
- Cement, steel, lime and other building materials are used in small quantities for construction of spillway, outlets etc.



TRUE COPY

BR'D
Principal
Vishwaniketan's (i) MEET

TYPES OF EARTHEN DAM:

1.HOMOGENEOUSEMBANKMENT TYPE:

A purely homogeneous type earth dam is composed of single kind of material.They are used only for low heights. A purely homogeneous section has been replaced by modified homogeneous section in which in drainage system inthe form of horizontal drain filter is provided. This controls action of seepage so as to p steeper slopes. These dams are composed of impervious or semi-impervious soils to provide an adequate

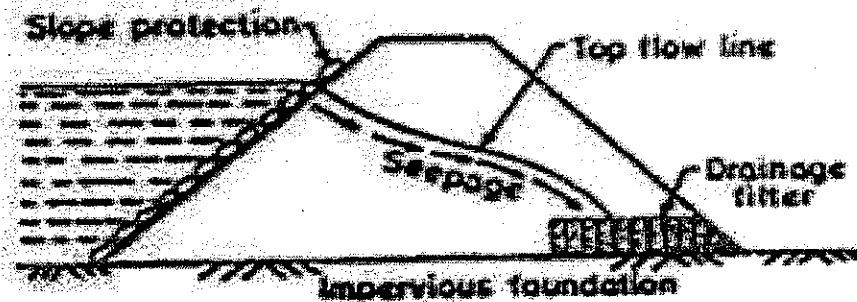

Homogeneous embankment provided with a drainage filter.

2.ZONED EMBANKMENT TYPE:

Zone embankment type earth dam is the one in which the dam is made up of more than one material.The provided with a central impervious core, covered by a pervious transition zone. A suitable drainage system of horizontal drain or rock toe is also provided at downstream side. Outer shells are made of pervious, free draining materials. The shells give stability to the central impervious fill and at the same time distribute lo larger area of foundation.



TRUE COPY

Principal
Vishwaniketan's (i MEET)

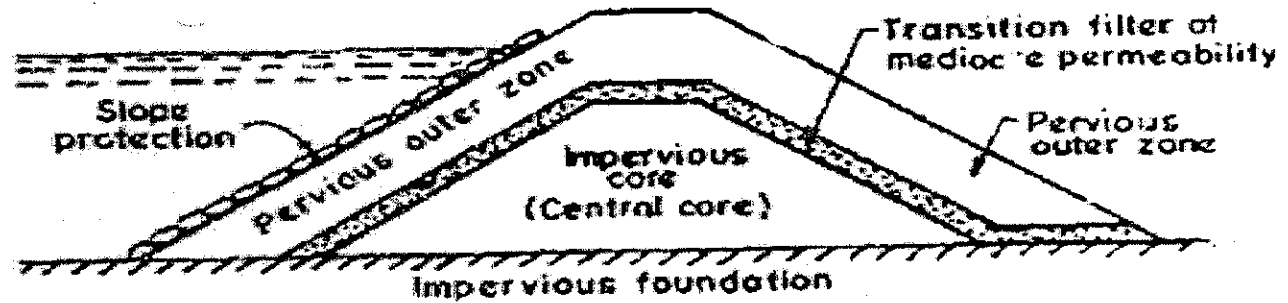

3. DIAPHRAGM EMBANKMENT TYPE:

In diaphragm embankment type, embankment is constructed of pervious material and thin diaphragm of impermeable material is provided to check the seepage. The diaphragm may be of impervious soil, cement concrete, bituminous concrete or any other material and may be placed either central vertical core

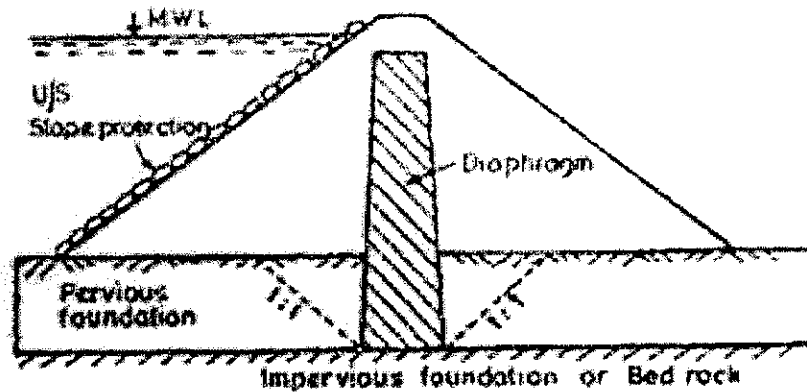

TRUE COPY

[Signature]
Principal
Vishwaniketan's (I) MEET

COMPONENT PARTS OF EARTHEN DAM:

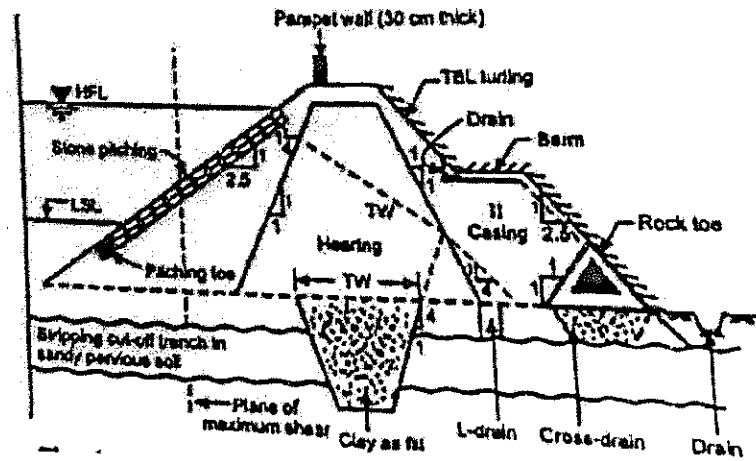

1. **Hearing (core):** It forms the central impervious section built with clayey soil, silt loam, etc. It provides water tightness to the dam and adequate shear resistance against slipping. Controls body of dam.
2. **Casing:** It forms outer portion of dam built with masonry, soft rock or sand & gravel. It provides cover to the hearing, protecting it from cracking. Provide stability to dam.
3. **Cut-off trench:** It is excavated below ground level under the hearing zone & filled with clayey soil. Its function is to prevent seepage flow through pervious foundation. It prevents piping of foundation.
4. **Rock toe:** It is constructed from rock pieces or boulders large than 20cm size. It helps to prevent sloughing of toe due to seepage flow.



TRUE COPY

[Handwritten Signature]

Principal
Vishwaniketan's (I MEET)

CONDITIONS OF STABILITY OF EARTHEN DAM:

1. The dam should not be overtopped by flood water.
2. The seepage line should be within the downstream face of the dam.
3. The upstream and downstream face should be stable under worst conditions.
4. The foundation shear stresses should be within the safe limit.
5. There should be no opportunity for free flow of water from upstream to downstream.
6. The upstream slope should be protected from wave action.
7. The dam and foundation should be safe against piping.



TRUE COPY

A handwritten signature in black ink, appearing to be "J.P." with a horizontal line underneath.

Principal
Vishwaniketan's (JMET)

GRAVITY DAM

A Gravity dam has been defined as a “structure which is designed in such a way that its own weight resists external forces”. A gravity dam is a dam constructed from concrete or stone masonry and designed to hold back water by using only the weight of the material and its resistance against the foundation to oppose the horizontal pressure of water pushing against it.

TYPES OF GRAVITY DAM:

Gravity dam are classified according to the material used for constructing them.

- 1. MASONRY DAM:** This type of dam is constructed with masonry which could be either of rubble or coursed masonry.
- 2. CONCRETE DAM:** They are constructed block by block by pouring good quality concrete

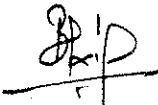

TRUE COPY

Principal
(MEET)

COMPONENT PARTS OF GRAVITY DAM:

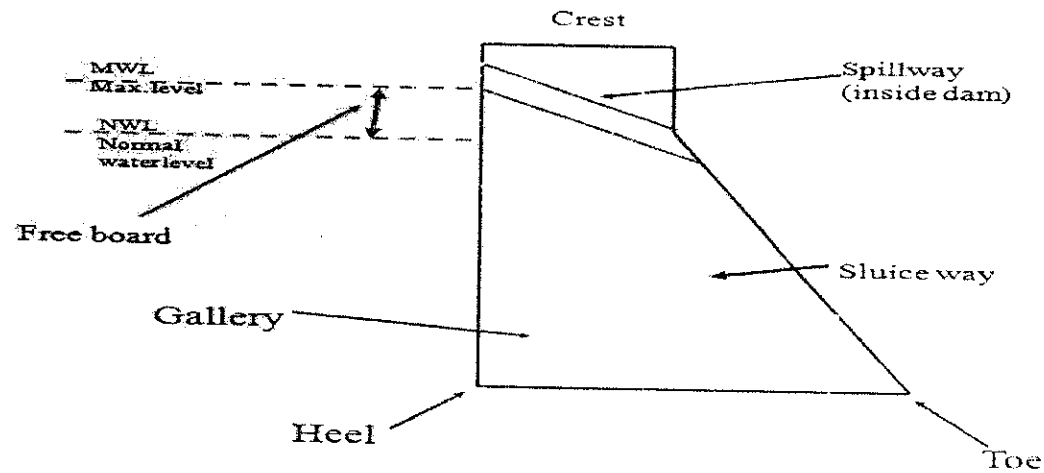

1. Heel-contact with the ground on the upstream side.
2. Toe-contact with the ground on the upstream side
3. Abutement-Sides of the valley on which the structure of the dam rest.
4. Galleries-small rooms like structure left within the dam for checking operations
5. Spillway-It is the arrangement near the top to release the excess water of the reservoir to downstream
6. Sluice Way-An opening in the dam near the ground level, which is used to clear the silt, accumulation reservoir side.
7. Divergen tunnel-Tunnels are constructed for diverting water before the construction of dam. This help the river bed dry.



TRUE COPY

J.P.
Principal

Vishwaniketan's (I) MEET



VISHWANIKETAN

Institute of Management Entrepreneurship & Engineering Technology [iMEET]

Affiliated to University of Mumbai, Approved by AICTE, New Delhi
Survey No.52, Kumbhivali, Near Khalapur Toll Naka, off. Mumbai-Pune Expressway, Tal Khalapur,
Dist - Raigad Pin- 410 202 Telephone - 02192 - 274 206/07/08/10 Fax - 02192 - 274 210

Dr. Ramjee Prasad
Hon. Chairman

Mr. Sunil Bangar
Secretary

Dr. B. R. Patil
Principal

Ref.No.: ViMEET/Visit/CE- /2019-20

Date: 01-03-2019

To,
SAI WORLD CITY,
PALSPE PHATA ON THE OLD
MUMBAI PUNE HIGHWAY
Navi Mumbai.

Subject: Permission for site visit to the paraside group sai world city.

Respected sir.

We would hereby like to request you to give permission for the visit of our third year civil engineering students to sai world city the on 13-3-2019. This visit surely will beneficial to our students to increase their knowledge and to get practical approach of subject

Vishwaniketan is a public trust established by professionals drawn from the industry, education and administration with excellent experience in the respective fields. The campus has been located near Navi Mumbai, at Khalapur on Mumbai- Pune expressway. This has created platform for students, teachers, researchers and professionals to adopt excellent teaching - learning practices based on project Based Learning (PBL). This will encourage entrepreneurship and finally support product-development through start-ups and empower teachers and the society by technology-solutions.

Please do needful, hoping for positive response.

Thank you.

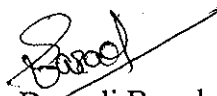
Deepali Barad
Subject coordinator

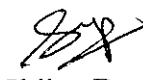
Prof. Shilpa Deshpande
HOD Civil Dept.

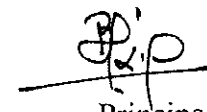
Principal
Vishwaniketan's iMEET



TRUE COPY



VISHWANIKETAN

Institute of Management Entrepreneurship & Engineering Technology [iMEET]

Affiliated to University of Mumbai, Approved by AICTE, New Delhi

Survey No.52, Kumbhivali, Near Khalapur Toll Naka, off. Mumbai-Pune Expressway, Tal Khalapur,

Dist - Raigad Pin- 410 202 Telephone - 02192 - 274 206/07/08/10 Fax - 02192 - 274 210

Dr. Ramjee Prasad
Hon. Chairman

Mr. Sunil Bangar
Secretary

Dr. B. R. Patil
Principal

Ref.No.: ViMEET/Visit/CE- /2019-20

Date: 12-03-2019

To,
SAI WORLD CITY,
PALSPE PHATA ON THE OLD
MUMBAI PUNE HIGHWAY
Navi Mumbai.

Subject: Thanking letter,

Respected sir.

We are very grateful for sparing your valuable time for guiding our third year students of civil engineering at your site. This will definitely provide right path towards the goal. Your resourceful interaction with the civil engineering students will definitely prove increase in their knowledge.

We thank you once again for your full cooperation. Look forward for more such interactions in future.

Thanking you.



Deepali Barad
Subject coordinator

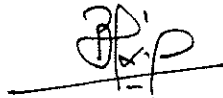

Prof. Shilpa Deshpande
HOD Civil Dept.

Principal
Vishwaniketan's iMEET

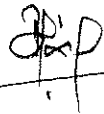

TRUE COPY

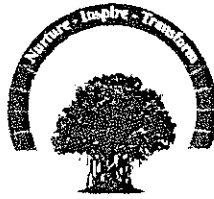



VISHWANIKETAN

ADVANCED CONSTRUCTION EQUIPMENT

INDUSTRIAL VISIT REPORT

Under the guidance of **Prof. Deepali Barad**

OBJECTIVE : Conducting an Industrial Visit on Advanced construction equipment.

PROJECT OVERVIEW :

An industrial visit to the ongoing site of the Paradise Group "Sai World City " located near Palasphata on the old Mumbai-Pune highway .

It is a mega township with themed amenities spread over 42 acres of land constituting of 13 towers 42 Floors each. Each tower 2, 3, 4, BHK apartments.

PRACTICAL OBSERVATION :

Mugging up the things in classrooms is not the right way of studying. This bores the students. A practical approach and giving hands on learning makes life easier and

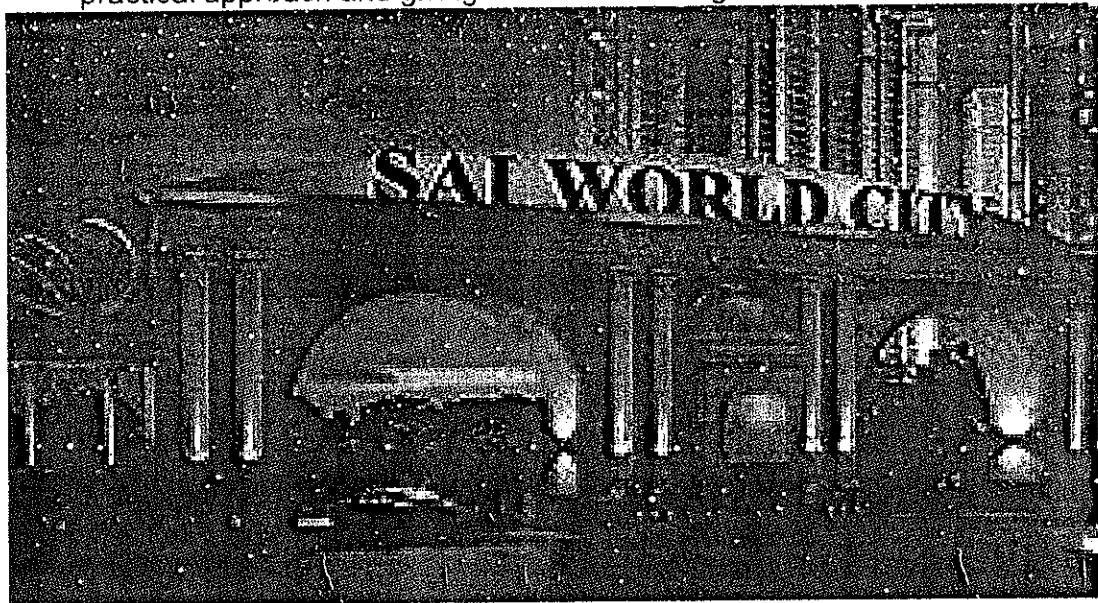

Mugging up the things in classrooms is not the right way of studying. This bores the students. A practical approach and giving hands on learning makes life easier and simpler. The purpose of the visit is to make us all accustomed to working on site in all conditions.

We reached the site at 9 am in the morning. After arriving there first we went to the lobby area where all the booking were going. There was a this proposed model that attracted everyones attention.



TRUE COPY

Principal
Vishwaniketan's (i MEET)

The supervisor of the site Mr. Anil Jadi headed us to the RMC plant. The plant was fully automatic working on weighing batch method. It has a capacity of mixing 0.5 m^3 concrete at a time and can mix $30 \text{ m}^3/\text{hr}$.



The plant has separate cement silos and GGBS silos stored. The operator gives the command from the operating room for the batch needed. The grade of concrete used on the site was M40. The RMC plant cancel out the use of the transit mixer which takes longer time to reach to the site RMC hence is useful in this condition. Batch plants combine a precise amount of rock, sand, water and cement together by weight, allowing specialty concrete mixtures to be developed and implemented on construction sites.

The someof the Construtions equipments we saw at the site are:

Transit Mixer is a piece of equipment that is used for transporting concrete and mortar or ready mix material from a concrete batching plant. This Mixer is a strong well designed piece of equipment meant for transporting concrete from plant directly to the place where it is to be poured.

Conmix Mixers are fitted with a water pump of 400 Ltrs/min. capacity at 3.5 bar pressure. A water tank of capacity 600 Ltrs with a water level indicator is supplied along with the mixer. An oil cooler has been provided in the system for efficient and trouble free working of the mixer.

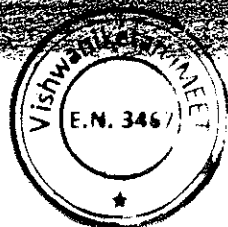
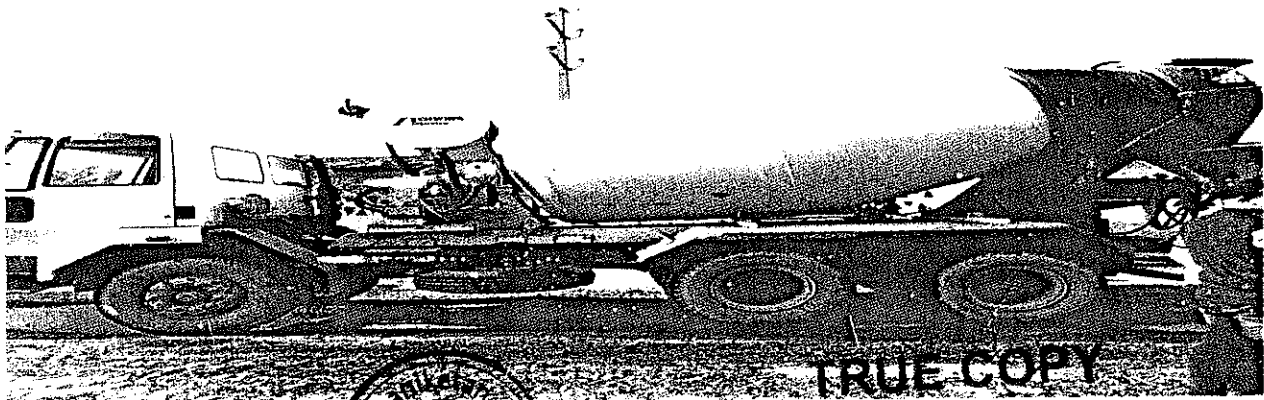

TRUE COPY

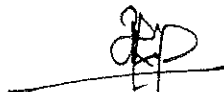
Principal
Vishwaniketan's (i MEET)

A **Backhoe** is a type of excavating equipment, or digger consisting of a digging bucket on the end of a two-part articulated arm. It is typically mounted on the back of a tractor or front loader the latter forming a backhoe loader. The section of the arm closest to the vehicle is known as the boom while the section which carries the bucket is known as the dipper (or dipper-stick), both terms derived from steam shovels. The boom is generally attached to the vehicle through a pivot known as the king-post, which allows the arm to pivot left and right, usually through a total of 180 to 200 degrees.

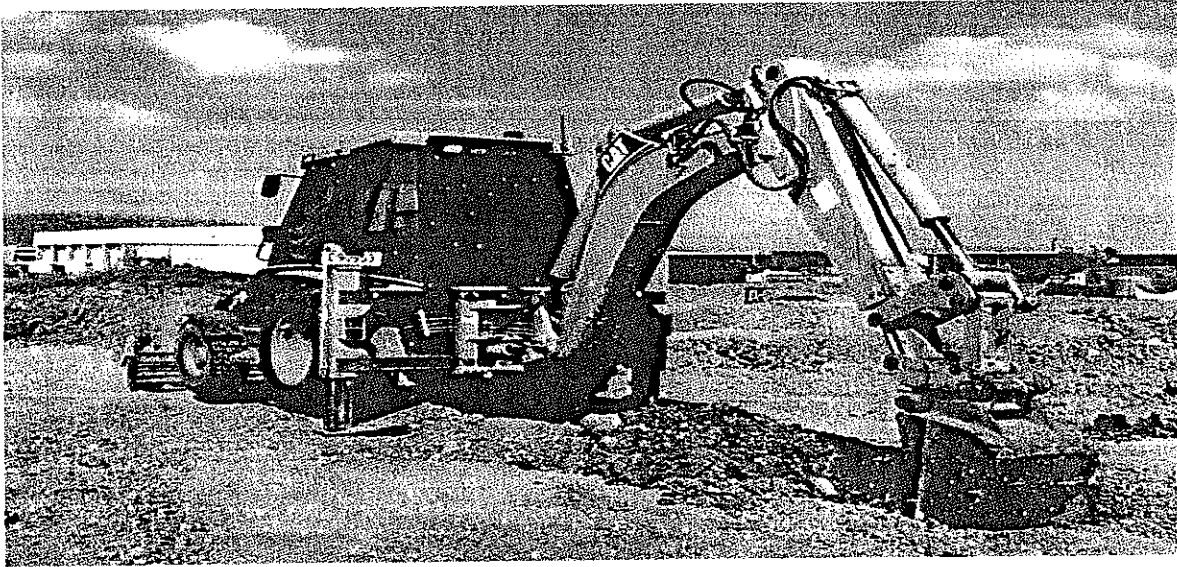

A **Power shovel** is a bucket-equipped machine, usually electrically powered, used for digging and loading earth or fragmented rock and for mineral extraction. Power Shovels are a type of rope/cable excavator, where the digging arm is controlled and powered by winches and steel ropes, rather than hydraulics like in the more common hydraulic excavators. Basics parts of power shovel including the track system, cabin, cables, rack, stick, boom foot-pin, saddle block, boom, boom point sheaves, and bucket. The size of bucket varies from 0.375cu m to 5cu m.

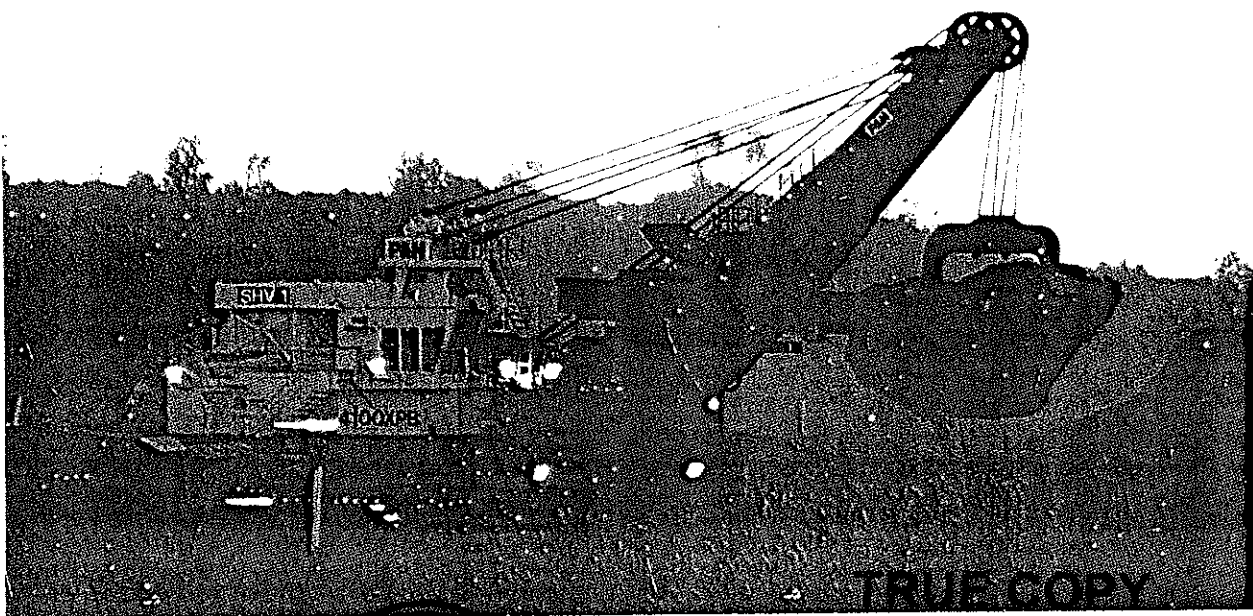

J.P.P.
Principal
Vishwaniketan's (I MEET)

CONCLUSION :

The industrial visit was very helpful and educational for all the students as it showed in a practical way the arrangement of various components and equipment on which makes the construction easier. The students were glad to know all of the things learned in classroom on a practical basis.



TRUE COPY

A handwritten signature in black ink, appearing to be "J.P.", written over a horizontal line.

Principal
Vishwaniketan's (i)MET

Vishwaniketan
Institute of Management Entrepreneurship and
Department : Civil Engineering
Class : BE Semester : VII (2019-20)

Sr No.	Name of Students	sign
A01	AMBADE VISHAKHA VINOD	<i>V Ambade</i>
A02	AWALE SUPRIYA SITARAM	<i>S Awale</i>
A03	BENDRE BHAGYASHREE RAVINDRA	<i>B Bendre</i>
A04	BHASE PRANAL RAMBHAI	<i>P Bhas</i>
A05	BHILARE SURAJ PRAKASH	
A06	BHOIR SHUBHAM HEMANT	
A07	BHOPI ROHAN RAGHUNATH	<i>R Bhoir</i>
A08	CHAVAN SANKET SURESH	
A09	CHAVAN VIKAS NAMDEV PURLABAI	<i>V Chavan</i>
A10	CHIMANE SANKET SANTOSH	
A11	CHITTE GAURAV VIKAS	<i>C Chitte</i>
A12	DANDEKAR MILAN LALIT	
A13	DEOKAR YOGESH PITAMBAR	<i>Y Deokar</i>
A14	DESAI MANGESH PANDURANG	
A15	DESHMUKH MAYUR SANJAY.	<i>M Deshmukh</i>
A16	DESHMUKH SANKET BAPURAO	
A17	DHENDE MAYUR SIDDHARTH	<i>M Dhende</i>
A18	GADGE AKASH BABAJI	
A19	GAIKWAD HARSHADA POPAT	<i>H Gaike</i>
A20	GAVHANE RUSHIKESH NAMDEO	
A21	GAWADE ROHIT DEVAPPA	<i>G Gawade</i>
A22	GAWAND NINAD RAVINDRA	
A23	GAWANDE SANJANA SHAILESH	
A24	GHANATE HARSHAL BABURAO	<i>H Ghanate</i>
A25	GHANGHAV HARSHVARDHAN MUKUND	
A26	GHARAT PRADNYA YASHAVANT	<i>P Gharat</i>
A27	GODE ABHISHEK JAYDEEP	
A28	GURAV ADITYA ADESH	<i>G Gurav</i>
A29	HEKRE SNEHAL SHARAD	
A30	JADHAV AKASH ARUN	
A31	JADHAV ANIKET SATISH	<i>A Jadhav</i>
A32	JADHAV SAMEER RAJENDRA	
A33	JADHAV SWARAJ JAYANT	<i>S Jadhav</i>
A34	JOSHI UDAY MAHESH	
A35	KADAM NIKHIL RAMA	<i>N Kadam</i>
A36	KALE PRADEEP RAMCHANDRA	
A37	KANTHALE SHUBHAM	<i>S Kantale</i>
A38	KARNUK VRUSHALI RAMBHAI	<i>V Karnuk</i>



TRUE COPY

[Signature]

Principal
Vishwaniketan's (i MEET)

A39	KAVALE SAURABH SURESH	
A40	KHAN SAJID AFZAL	
A41	KHEDEKAR SANKALP SHARAD	<u>SANKALP</u>
A42	KHUTLE PRATIKESH	
A43	KOKARE VISHAL BALU	<u>VKokare</u>
A44	KOLI ROHAN JANGAN	
A45	KOTHEKAR JANHAVI DATTATRAY	<u>Rkoti</u>
A46	KULKARNI KAUSTUBH SACHIN	<u>Kulkarni</u>
A47	KULKARNI PARAG ANANT	<u>Kulkarni</u>
A48	KULKARNI SAMEER MAHESH	<u>Kulkarni</u>
A49	KURANGALE KIRAN KRUSHNA	
A50	MADANE NANDINI DILIP	<u>Nandini</u>
A51	MADHAVI CHAITANYA KISHOR	
A52	MADHAVI TANMAY DNYANE	<u>Amallani</u>
A53	MADKE DARSHAN BHARAT	
A54	MADKE MRUNAL MALHARI	<u>MRunali</u>
A55	MAHABALE SATYAVAN VISHWANATH	
A56	MAHADIK CHAITANYA CHANDRAKANT	<u>Amaladi</u>
A57	MAHARNUR SURAJ ARUN	
A59	MALI SAGAR SANTOSH	<u>Smalis</u>
A61	MHATRE BHUSHAN VISHWANATH	
A62	MHATRE DIKSHITA BALIRAM	<u>Dikshita</u>
B01	MAGAR PRADNESH	<u>Magar</u>
B02	MHATRE NISHANT CHANDRASHEKHAR	
B03	MHATRE PRATIK BHANUDAS	
B04	MHATRE SIDDHANT SANJAY	<u>Siddhant</u>
B05	MHATRE VIPUL SHRIPAT	
B06	MOHITE MANSEE MOHAN	<u>Mohite</u>
B07	MOKAL HARSHADA VISHVANATH	
B08	MOKAL PRAJWAL SUNIL	
B09	MOKAL SHUBHAM SANTOSH	<u>Mokalshub</u>
B10	MORE PRADEEP SHRIRAM	
B11	MUJAWAR SALMAN TASLIM	
B12	MUKKU PRASANTHA KUMAR V REDDY	<u>Mukku</u>
B13	NAGDIVE NIVESH SUDHIR	
B14	NAIK JAYESH CHANDRAKANT	<u>Naik</u>
B15	NARANGIKAR HARSHADA	
B16	NAVALE SANJEEVANI SURYAKANT	
B17	OJHA SANJEEV KUMAR	<u>Ojha</u>
B18	OSWAL DUSHANT MANISH	
B19	PADWANKAR SAURABH SANJAY	<u>Saurabh</u>
B20	PANDHARE RUSHIKESH DNYANDEV	<u>Pandhare</u>
B21	PATIL AARTI PRALHAD	<u>Patil</u>
B22	PATIL HARSHAD RAMDAS 0	

TRUE COPY



H.P.
Principal
Vishwaniketan's (I N EET)

B23	PATIL KEDAR SHARAD	
B24	PATIL OMKAR KISHOR	<i>Patil Om</i>
B25	PATIL OMKAR MADHUKAR	
B26	PATIL PRATIK NARAYAN	
B27	PATIL PRATIKSHA YASHVANT	<i>Pratiksha</i>
B28	PATIL RATNESH RAMKANT	
B29	PATIL SAYLI ANIL	
B30	PATIL SAYLI KISHOR	<i>Sayli</i>
B31	PATIL SHUBHAM MOHAN	
B32	PATIL TEJAL VASUDEV	<i>Patil Shubham</i>
B33	PATIL TEJASWINI VIKAS	
B34	PATIL UMANG DHANAJI	<i>Umang</i>
B35	PETHE ANIKIT RAJENDRA	
B36	PINGALE ROHINI SANTOSH	
B37	POKHARKAR NILESH RAMDAS	<i>Pingale</i>
B38	RANGARI VIPUL DEVENAND	
B39	SAITAWADEKAR SAURABH RAMESH	
B40	SALUNKHE SWAPNIL RAJU	<i>Salunkhe</i>
B41	SALVI PRASENJIT RAJESH	
B42	SANAP ABHISHEK SHAILESH	<i>Rajesh Sanap</i>
B43	SAPKAL PIYUSH RAJESH	
B44	SARDESAI DIGVIJAY	
B45	SATVE AKASHAY ANANTA	<i>Ashve</i>
B46	SAVALE BHUPESH HIMMTRAO	
B47	SAWANT CHIRAG DEEPAK	<i>Chirag Sawant</i>
B48	SAWANT PRATIK JAGDISH	
B49	SHAH VISHESH SANDEEP	
B50	SHAIKH REHMAN SAB	<i>Sai</i>
B51	SHARMA VIKASH MANOJ	
B52	SHETE NIKHIL NIVIN	<i>Sharma</i>
B53	SHINDE ANKITA PRASHANT	
B54	SHINDE VISHAL PRAKASH	<i>Shinde</i>
B55	SHIRKE ASHITOSH SURESH	
B56	SINGH SANJU ARUNKUMAR	
B57	SURYAWANSHI SIDDHANT BANDOPANT	<i>Surya</i>
B58	THAKUR ABHISHEK ANIL	
B59	THAKUR OMKAR ANAND	<i>Thakur Om</i>
B60	THAKUR SARVESH CHANDRASHEKHAR	
B61	THAKUR SHILPA NARAYAN	<i>Shilpa</i>
B62	THAKUR VAIBHAV PURUSHOTTAM	<i>Vaibhav</i>
B63	THAKUR VRUSHAL RAJESH	
B64	THUBE PRATIKSHA GITARAM	<i>Pratiksha</i>
B65	TURE ANIKET ANANTA	
B66	UGHADA VILAS DURGADAS	<i>Ughade</i>

TRUE COPY



[Signature]
Principal
Vishwaniketan's (I MEET)

B67	WA	PANKAJ BALU	Waghur
B68	WA	MARE BHAGYASHRI MOHAN	Waghmare
B69	WA	DE SNEHAL PRADEEP	Snehal
B70	THC	T ROHIT KISHOR	Rohit



TRUE COPY

J.P.
Principal
Vishwaniketan's (i MEET)



VISHWANIKETAN'S
Institute of Management Entrepreneurship & Engineering Technology [i MEET]
Affiliated to University of Mumbai, Approved by AICTE, New Delhi

DTE CODE NO. EN: 3467

Survey No. 52, Khumbhivali, Near Khalapur Toll Naka, off. Mumbai-Pune Expressway, Tal. - Khalapur,
Dist - Raigad - Pin - 410 202 Telephone - 02192 - 274 206/07/08/10 Fax - 02192 - 274 210

Dr. Ramjee Prasad
Hon Chairman

Mr. Sunil Bangar
Secretary

Dr. B. R. Patil
Principal

Ref. No. : ViMEET / Visit / CE -457/2019-20

Date: 04/10/2019

To,

Executive Engineer (Hetawane),
5th floor, Raigad bhavan, CBD
Belapur,

Subject: Permission for visit to Water Treatment Plant

Dear Sir,

We would hereby, like to request you to give permission for the visit of our Third year Civil Students to your, Water Treatment Plant, Navi Mumbai. This visit surely will be beneficial to our students to increase their knowledge and to get practical approach of subject.

Vishwaniketan is a public trust established by professionals drawn from the industry, education and administration with excellent experience in the respective fields. The campus has been located near Navi Mumbai, at Khalapur on Mumbai- Pune expressway. This has created platform for students, teachers, researchers and professionals to adopt excellent teaching – learning practices based on project Based Learning (PBL). This will encourage entrepreneurship and finally support product-development through start-ups and empower teachers and the society by technology-solutions.

Thank you.

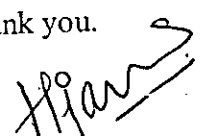
Dr. Heena Jain
Subject Coordinator

Prof. Shilpa Deshpande
H.O.D Civil Dept.
Head of Department
Civil Engineering
Vishwaniketan's iMEET

Dr. B.R. Patil
Principal, ViMEET

TRUE COPY





VISHWANIKETAN'S
INSTITUTE OF MANAGEMENT ENTREPRENEURSHIP AND ENGINEERING TECHNOLOGY

T.E. CIVIL

AY 2018-19

(B DIV)

ROLL CALL LIST SHEET

DEPARTMENT OF CIVIL ENGINEERING

Name of Faculty :

Subject

Sr. No.	NAME OF THE STUDENT	Date: 23/8/18	1	2	3	4	5	6	7	8	9	10
B01	MHATRE NISHANT CHANDRASHEKHAR	<i>[Signature]</i>										
B02	MHATRE NISHANT MANOHAR	<i>[Signature]</i>										
B03	MHATRE PRATIK BHANUDAS											
B04	MHATRE VIPUL SHRI PAT	<i>[Signature]</i>										
B05	MOHITE MANSEE MOHAN											
B06	MOKAL HARSHADA VISHVANATH	<i>[Signature]</i>										
B07	MOKAL PRAJWAL SUNIL	<i>[Signature]</i>										
B08	MOKAL SHUBHAM SANTOSH	<i>[Signature]</i>										
B09	MOTE TEJAS CHANDRAKANT											
B10	MUJAWAR SALMAN TASLIM	<i>[Signature]</i>										
B11	MUKKU PRASANTHA KUMAR V REDDY	<i>[Signature]</i>										
B12	NAGDIVE NIVESH SUDHIR											
B13	NAIK JAYESH CHANDRAKANT	<i>[Signature]</i>										
B14	NARANGIKAR HARSHADA											
B15	NAVALE SANJEEVANI SURYAKANT											
B16	OJHA SANJEEV KUMAR	<i>[Signature]</i>										
B17	OSWAL DUSHANT MANISH											
B18	PADWANKAR SAURABH SANJAY	<i>[Signature]</i>										
B19	PARDHARE AKSHAY KUNDALIK											
B20	PATIL AARTI PRALHAD	<i>[Signature]</i>										

TRUE COPY

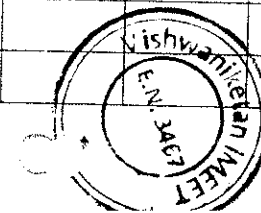

[Signature]
Principal
Vishwaniketan's (I MEET)

Sr. No.	NAME OF THE STUDENT	Date										
		23/8/18	1	2	3	4	5	6	7	8	9	10
B21	PATIL KEDAR SHARAD											
B22	PATIL OMKAR KISHOR	<i>Omkar</i>										
B23	PATIL OMKAR MADHUKAR											
B24	PATIL RAHUL SURESH											
B25	PATIL RATNESH RAMKANT	<i>Ratnesh</i>										
B26	PATIL SAYLI ANIL	<i>Sayli</i>										
B27	PATIL SHUBHAM MOHAN	<i>Shubham</i>										
B28	PATIL TEJAL VASUDEV	<i>Tejal</i>										
B29	PATIL TEJASWINI VIKAS	<i>Tejaswini</i>										
B30	PATIL UMANG DHANAJI	<i>U.D. Patil</i>										
B31	PAWAR ASHUTOSH SHIVAJI											
B32	PINGALE ROHINI SANTOSH	<i>Pingale</i>										
B33	POKHARKAR NILESH RAMDAS											
B34	PUNYARTHI RUSHIKESH SADANAND											
B35	RANGARI VIPUL DEVENAND											
B36	SAITAWADEKAR SAURABH RAMESH	<i>Saurabh</i>										
B37	SALVI PRASENJIT RAJESH											
B38	SANAP ABHISHEK SHAILESH	<i>Sanap</i>										
B39	SAPKAL PIYUSH RAJESH											

TRUE COPY

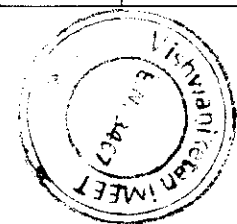

J.P.
Principal
Vishwaniketan's (I) MEET

Sr. No.	NAME OF THE STUDENT	Date													
		23/8/18	1	2	3	4	5	6	7	8	9	10			
B40	SAWANT CHIRAG DEEPAK														
B41	SAWANT PRATIK JAGDISH	<i>Sawant</i>													
B42	SHAH VISHESH SANDEEP	<i>Shah</i>													
B43	SHINDE NIKHIL RAMESH														
B44	SHINDE VISHAL PRAKASH	<i>Shinde</i>													
B45	SHIRKE ASHITOSH SURESH														
B46	SINGH SANJU ARUNKUMAR														
B47	THAKUR ABHISHEK ANIL	<i>Abhi</i>													
B48	THAKUR OMKAR ANAND	<i>Omkar</i>													
B49	THAKUR SARVESH CHANDRASHEKHAR														
B50	THAKUR SHILPA NARAYAN	<i>Shilpa</i>													
B51	THAKUR VAIBHAV PURUSHOTTAM														
B52	THORAT ROHIT KISHOR														
B53	THUBE PRATIKSHA GITARAM														
B54	UGHADA VILAS DURGADAS														
B55	WAGH PANKAJ BALU	<i>Pankaj</i>													
B56	WAGHMARE BHAGYASHRI MOHAN														
B57	WAKADE SNEHAL PRADEEP														
B58	SHINDE ANKITA	<i>Ankita</i>													

TRUE COPY



[Signature]
Principal
Vishwaniketan's (I MEET)

Sl. No.	NAME OF THE STUDENT	Date: 23/8/18												
		1	2	3	4	5	6	7	8	9	10			
B59	MULEY PRANAY TEJRAO (P)													
B60	NANDURKAR SHRUTIKA PRAMOD (P)	<u>S.Nandur</u>												
B61	NIKALJE ABHISHEK PRATAP (P)													
B62	PADWAL SOHAN NAI BHAU (P)													
B63	PANDEY NEERAJ RAMCHNADRA (P)													
B64	PANDHARE RUSHIKESH DNYANDEV (P)	<u>Pandhare</u>												
B65	PARDESHI RUSHIKESH CHANDRAKANT (P)													
B66	PAREKH RUSHABH MILAN (P)													
B67	PATIL JAYESH MOHAN	<u>Jayesh</u>												
B68	PATOLIA ABHISHEK K													
B69	PETHE ANIKIT R.													
B70	PATIL KAJAL DILIP (P)	<u>Kajal</u>												
B71	PATIL KALYAN PRALHAD(P)													
B72	PATIL PRATIKSHA(P)	<u>Pratiksha</u>												
B73	PATIL PRITIKA(P)													
B74	PATIL RONAK SANJIVAN(P)													
B75	PATIL RUTUJA(P)													
B76	PATIL SAGAR RAMESH(P)	<u>Sagar</u>												
B77	PATIL SAMIKSHA (P)													
B78	PATIL SUMIT SHARAD(P)													
B79	PATIL TUSHAR VIJAY(P)	<u>Tushar</u>												
B80	PATIL VINAYA MADAN(P)													
B81	PIMPARKAR SONALI ASHOK (P)													
B82	RAU I MANSOOR HASAN(P)	<u>Mansoor</u>												
B83	SALANI UMESH BALRAM(P)													

TRUE COPY



[Signature]
Principal
Vishwaniketan's (I) MEET

Sr. No.	NAME OF THE STUDENT	Date												
		1	2	3	4	5	6	7	8	9	10			
B84	SATVE AKASHAY ANANTA	<i>Asave</i>												
B85	SALUNKE AKSHAY SURESH (P)	<i>Salunke</i>												
B86	SALAVI DARSHAN MANOHAR													
B87	SAVALE BHUPESH HIMMTRAO (P)	<i>Savale</i>												
B88	SHARMA VIKASH MANOJ (P)													
B89	SHETYE RIDDHI ASH. SH MANSI (P)	<i>Shetye</i>												
B90	SOY ANAND NANDLAL (P)	<i>Soy</i>												
B91	SURYAWANSHI SIDDHANT BANDOPANT (P)													
B92	TANDEL PRAJAKTA HARISHCHANDRA (P)													
B93	THAKUR SURAJ BHARAT (P)	<i>Thakur</i>												
B94	WANALEKAR VARSHA HANUMANTRAO(P)													
B95	WARGE YASH SANJAY(P)	<i>Warge</i>												
B96	YADAV NIRANJAN VITTHAL (P)													

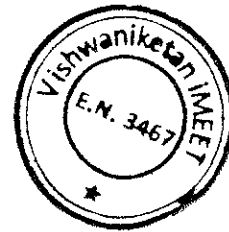

TRUE COPY

[Signature]
Principal
Vishwaniketan's (I MEET)